Caution



Do not exceed the operating input power, voltage, and current level and signal type appropriate for the instrument being used, refer to your instrument's Operation Manual.



Electrostatic discharge(ESD) can damage the highly sensitive microcircuits in your instrument. ESD damage is most likely to occur as the test fixtures are being connected or disconnected. Protect them from ESD damage by wearing a grounding strap that provides a high resistance path to ground. Alternatively, ground yourself to discharge any static charge built-up by touching the outer shell of any grounded instrument chassis before touching the test port connectors..

注意



過剰な入力電力、電圧、電流および測定器の使用する信号の種類に注意してください。詳しくは測定器の機能解説書を参照してください。



計測器には、静電気による放電によって破壊される恐れのある電子回路が含まれています。これらの静電破壊は、多くの場合テストフィクスチャの接続、取り外し時に発生します。測定器を静電気による破壊から守るために、グラウンド・ストラップを使用して体を接地してください。あるいは、テストポートコネクタに触る前に、接地された測定器の筐体などに触れて静電気を放電してください。

Safety Summary

When you notice any of the unusual conditions listed below, immediately terminate operation and disconnect the power cable.

Contact your local Agilent Technologies sales representative or authorized service company for repair of the instrument. If you continue to operate without repairing the instrument, there is a potential fire or shock hazard for the operator.

- Instrument operates abnormally.
- Instrument emits abnormal noise, smell, smoke or a spark-like light during the operation.
- Instrument generates high temperature or electrical shock during operation.
- Power cable, plug, or receptacle on instrument is damaged.
- Foreign substance or liquid has fallen into the instrument.

使用上の安全について

以下のような異常が見られたときは、直ちに使用を中止して電源プラグを抜き、最寄りの当社セールス・オフィスまたは当社指定のサービス会社に連絡して修理を受けて下さい。そのまま使用を続けると、火災や感電のおそれがあります。

- 正常な動作をしない。
- 動作中に異音、異臭、発煙あるいはスパークのような光が発生した。
- 使用時に異常な高温や電気ショックを感じた。
- 電源コード、電源プラグ、電源コネクタが損傷した。
- 製品内に異物、液体などが入った。

Herstellerbescheinigung

GERÄUSCHEMISSION

LpA < 70 dB
am Arbeitsplatz
normaler Betrieb
nach DIN 45635 T. 19

Manufacturer's Declaration

ACOUSTIC NOISE EMISSION

LpA < 70 dB
operator position
normal operation
per ISO 7779



Agilent Technologies
Innovating the HP Way

DECLARATION OF CONFORMITY

According to ISO/IEC Guide 22 and CEN/CENELEC EN 45014

Manufacturer's Name: Agilent Technologies Japan, Ltd.
Manufacturer's Address: Component Test PGU-Kobe
1-3-2, Murotani, Nishi-ku, Kobe-shi,
Hyogo, 651-2241 Japan

Declares, that the product

Product Name: RF Impedance / Material Analyzer
Model Number: 4291B
Product Options: All options and customized products based on the above

Is in conformity with:

EMC European Council Directive 89/336/EEC and carries the CE-marking accordingly
EMC Standards required by the Australia Radio Communications Act
IEC 61326-1:1997+A1 / EN 61326-1:1997+A1
CISPR 11:1990 / EN 55011:1991 / AS/NZS 2064.1- Group 1 Class A ^[1]
IEC 61000-4-2:1995 / EN 61000-4-2:1995 (4 kV CD, 8 kV AD)
IEC 61000-4-3:1995 / EN 61000-4-3:1996 (3 V/m 80% AM 27 - 1000 MHz)
IEC 61000-4-4:1995 / EN 61000-4-4:1995 (1 kV power line, 0.5 kV Signal line)
IEC 61000-4-5:1995 / EN 61000-4-5:1995 (0.5 kV line-line, 1 kV line-earth)
IEC 61000-4-6:1996 / EN 61000-4-6:1996 (3 V 80% AM, power line)
IEC 61000-4-11:1994 / EN 61000-4-11:1994 (100% 1cycle)

Safety European Council Directive 73/23/EEC and carries the CE-marking accordingly
IEC 61010-1:1990+A1+A2 / EN 61010-1:1993+A2
CAN / CSA C22.2 No. 1010.1-92

Additional Information:

LEDs in this product are Class 1 in accordance with EN 60825-1:1994.

^[1] The product was tested in a typical configuration.

Dec. 15, 1999

Date

Name Yukihiro Ota / Quality Engineering Manager

For further information, please contact your local Agilent Technologies sales office, agent or distributor.

**Agilent 4291B RF Impedance/Material
Analyzer**

Operation Manual



Agilent Technologies

**Agilent Part No. 04291-90040
Printed in Japan September 2002**

Fifth Edition

Notice

The information contained in this document is subject to change without notice.

This document contains proprietary information that is protected by copyright. All rights are reserved. No part of this document may be photocopied, reproduced, or translated to another language without the prior written consent of the Agilent Technologies.

Agilent Technologies Japan, Ltd.
Component Test PGU-Kobe
1-3-2, Murotani, Nishi-ku, Kobe-shi,
Hyogo, 651-2241 Japan

© Copyright 1997, 1998, 1999, 2001, 2002
Agilent Technologies Japan, Ltd.

For additional important information about serial numbers, read
“Serial Number” in Appendix A.

Manual Printing History

The manual's printing date and part number indicate its current edition. The printing date changes when a new edition is printed. (Minor corrections and updates that are incorporated at reprint do not cause the date to change.) The manual part number changes when extensive technical changes are incorporated.

December 1997 First Edition (part number: 04291-90020)
September 1998 Second Edition (part number: 04291-90030)
December 1999 Third Edition (part number: 04291-90030)
January 2001 Fourth Edition (part number: 04291-90030)
September 2002 Fifth Edition (part number: 04291-90040)

MS-DOS[®] is a registered trademark of Microsoft Corporation.
APC-7[®] is a registered trademark of Bunker Ramo Corporation.

Safety Summary

The following general safety precautions must be observed during all phases of operation, service, and repair of this instrument. Failure to comply with these precautions or with specific *WARNINGS* elsewhere in this manual may impair the protection provided by the equipment. In addition it violates safety standards of design, manufacture, and intended use of the instrument.

The Agilent Technologies assumes no liability for the customer's failure to comply with these requirements.

Note



4291B comply with INSTALLATION CATEGORY II and POLLUTION DEGREE 2 in IEC1010-1. 4291B are INDOOR USE product.

Note



LEDs in 4291B are Class 1 in accordance with IEC825-1. CLASS 1 LED PRODUCT

Ground The Instrument

To avoid electric shock hazard, the instrument chassis and cabinet must be connected to a safety earth ground by the supplied power cable with earth blade.

DO NOT Operate In An Explosive Atmosphere

Do not operate the instrument in the presence of flammable gasses or fumes. Operation of any electrical instrument in such an environment constitutes a definite safety hazard.

Keep Away From Live Circuits

Operating personnel must not remove instrument covers. Component replacement and internal adjustments must be made by qualified maintenance personnel. Do not replace components with the power cable connected. Under certain conditions, dangerous voltages may exist even with the power cable removed. To avoid injuries, always disconnect power and discharge circuits before touching them.

DO NOT Service Or Adjust Alone

Do not attempt internal service or adjustment unless another person, capable of rendering first aid and resuscitation, is present.

DO NOT Substitute Parts Or Modify Instrument

Because of the danger of introducing additional hazards, do not install substitute parts or perform unauthorized modifications to the instrument. Return the instrument to a Agilent Technologies Sales and Service Office for service and repair to ensure that safety features are maintained.

Dangerous Procedure Warnings

Warnings , such as the example below, precede potentially dangerous procedures throughout this manual. Instructions contained in the warnings must be followed.

Warning



Dangerous voltages, capable of causing death, are present in this instrument. Use extreme caution when handling, testing, and adjusting this instrument.

Safety Symbols

General definitions of safety symbols used on equipment or in manuals are listed below.



Instruction manual symbol: the product is marked with this symbol when it is necessary for the user to refer to the instruction manual.



Alternating current.



Direct current.



On (Supply).



Off (Supply).



In position of push-button switch.



Out position of push-button switch.



Frame (or chassis) terminal. A connection to the frame (chassis) of the equipment which normally include all exposed metal structures.

Warning



This **Warning** sign denotes a hazard. It calls attention to a procedure, practice, condition or the like, which, if not correctly performed or adhered to, could result in injury or death to personnel.

Caution



This **Caution** sign denotes a hazard. It calls attention to a procedure, practice, condition or the like, which, if not correctly performed or adhered to, could result in damage to or destruction of part or all of the product.

Note



This **Note** sign denotes important information. It calls attention to a procedure, practice, condition or the like, which is essential to highlight.



Affixed to product containing static sensitive devices use anti-static handling procedures to prevent electrostatic discharge damage to component.

Typeface Conventions

Bold

Boldface type is used when a term is defined. For example: **icons** are symbols.

Italics

Italic type is used for emphasis and for titles of manuals and other publications.

Italic type is also used for keyboard entries when a name or a variable must be typed in place of the words in italics. For example: copy *filename* means to type the word copy, to type a space, and then to type the name of a file such as *file1*.

Computer

Computer font is used for on-screen prompts and messages.

HARDKEYS

Labeled keys on the instrument front panel are enclosed in **□**.

SOFTKEYS

Softkeys located to the right of the LCD are enclosed in **■**.

Certification

Agilent Technologies certifies that this product met its published specifications at the time of shipment from the factory. Agilent Technologies further certifies that its calibration measurements are traceable to the United States National Institute of Standards and Technology, to the extent allowed by the Institution's calibration facility, or to the calibration facilities of other International Standards Organization members.

Warranty

This Agilent Technologies instrument product is warranted against defects in material and workmanship for a period of one year from the date of shipment, except that in the case of certain components listed in *General Information* of this manual, the warranty shall be for the specified period. During the warranty period, Agilent Technologies will, at its option, either repair or replace products that prove to be defective.

For warranty service or repair, this product must be returned to a service facility designated by Agilent Technologies. Buyer shall prepay shipping charges to Agilent Technologies and Agilent Technologies shall pay shipping charges to return the product to Buyer. However, Buyer shall pay all shipping charges, duties, and taxes for products returned to Agilent Technologies from another country.

Agilent Technologies warrants that its software and firmware designated by Agilent Technologies for use with an instrument will execute its programming instruction when properly installed on that instrument. Agilent Technologies does not warrant that the operation of the instrument, or software, or firmware will be uninterrupted or error free.

Limitation Of Warranty

The foregoing warranty shall not apply to defects resulting from improper or inadequate maintenance by Buyer, Buyer-supplied software or interfacing, unauthorized modification or misuse, operation outside the environmental specifications for the product, or improper site preparation or maintenance.

No other warranty is expressed or implied. Agilent Technologies specifically disclaims the implied warranties of merchantability and fitness for a particular purpose.

Exclusive Remedies

The remedies provided herein are buyer's sole and exclusive remedies. Agilent Technologies shall not be liable for any direct, indirect, special, incidental, or consequential damages, whether based on contract, tort, or any other legal theory.

Assistance

Product maintenance agreements and other customer assistance agreements are available for Agilent Technologies products.

For any assistance, contact your nearest Agilent Technologies Sales and Service Office. Addresses are provided at the back of this manual.

How to Use This manual

The *Operation Manual* describes all functions accessed from the front panel keys and softkeys. It also provides information on options and accessories available, and the analyzer features.

Chapter 1 Introduction

Chapter 1 provides overviews of the system and main features of the analyzer.

Chapter 2 Front and Rear Panel

Chapter 2 shows front and rear panel, test station, and test heads with descriptions. This chapter also provides the information on I/O port on the rear panel. The following chapter 3 through 8 provides front keys and softkeys reference. Each key and softkey are categorized by the key blocks on the front panel keys.

Chapter 3 Active Channel Block

Chapter 3 describes **Chan 1** or **Chan 2** keys in the active channel block, which is used to select channel.

Chapter 4 Entry Block

Chapter 4 describes the Entry Block, which is used to enter parameter value to the analyzer or to change setting of the analyzer.

Chapter 5 Measurement Block

Chapter 5 describes **Meas**, **Format**, **Display**, **Scale Ref**, **Cal**, **Bw/Avg** keys in the measurement block, which is used to corneal measurement capability of the analyzer. The equivalent circuit function is also explained in this chapter.

Chapter 6 Stimulus Block

Chapter 6 describes **Sweep**, **Source**, **Trigger**, **Start**, **Stop**, **Center**, and **Span** keys in the Stimulus Block, which is used to control the stimulus source, sweep functions.

Chapter 7 Marker Block

Chapter 7 describes **Marker**, **Search**, **Marker⇒**, **Utility** keys in the marker block, which is used to control the marker function.

Chapter 8 Instrument State Block

Chapter 8 describes **System**, **Local**, **Preset**, **Copy**, **Save**, and **Recall** keys in the Instrument State block. **System** key section describes the capability to control channel-independent system function; controlling the Agilent Technologies Instrument BASIC capability, adjusting internal clock, turning beeper on/off, controlling, and making limit line and executing limit testing. **Local** key section describes the capability to control GPIB, **Copy** key section describes making hard copy of the LCD image or listing measurement value or the analyzer setting. **Save** and **Recall** section describes the storage capability of analyzer and also provides the information on file structure to be saved in a disk.

Chapter 9 Analyzer Features

Chapter 10 shows analyzer's simplified block diagram and explains the data processing flow in the analyzer.

Chapter 10 Options and Accessories Available

Chapter 10 provides the information on the options and accessories available.

Chapter 11 Measurement Basic

Chapter 11 provides basic theory for impedance and material measurements.

Chapter 12 4291B RF Impedance/Material Analyzer Specifications

Chapter 12 provides the specification of the 4291B.

Appendix A Manual Changes

Appendix A contains the information required to adapt this manual to earlier version or configurations of the analyzer than the current printing date of this manual.

Appendix B Input Range and Default Settings

Appendix B lists input ranges, preset values when **Preset** key is pressed or the analyzer receives *RST command through GPIB, and power ON default setting.

Appendix C Temperature Coefficient Measurement

Appendix C describes a high temperature test head, a high temperature fixture, and temperature coefficient measurement software.

Error Messages

Error messages lists all error messages with an explanations for each error.

Contents

1. Introduction	
Introduction	1-1
System Overview	1-2
Analyzer features	1-4
Front and Rear Panels	1-4
ACTIVE CHANNEL Block	1-4
ENTRY Block	1-4
MEASUREMENT Block	1-4
STIMULUS Block	1-5
MARKER Block	1-5
INSTRUMENT STATE Block	1-6
2. Front and Rear Panel, Test Station, and Test Heads	
Front Panel	2-1
1. Front Panel Keys and Softkeys	2-2
Softkeys that are Joined by Vertical Lines	2-2
Softkeys That Toggle On or Off	2-2
Softkeys that Show Status Indications in Brackets	2-2
2. GPIB “REMOTE” Indicator	2-3
3. Preset	2-3
4. Test Station Connectors	2-3
5. Floppy Disk Drive	2-3
6. LINE Switch	2-3
Screen display	2-4
1. Active Channel	2-4
2. Measured parameter	2-5
3. Scale/Div	2-5
4. Reference Level	2-5
5. Marker Data Readout	2-5
6. Level Monitor, Marker Statistics and Width Value	2-5
7. Softkey Labels	2-5
8. Pass/Fail	2-5
9. DC BIAS ON notation	2-6
10. DC Bias Level	2-6
11. Instrument BASIC Status (Run Light)	2-6
12. Stimulus Span/Stop Value	2-6
13. CW Frequency	2-6
14. Stimulus Center/Start Value	2-6
15. OSC Level	2-6
16. Status Notations	2-7
17. Equivalent Circuit Parameters	2-7
18. External Reference	2-7
19. Active Entry Area	2-8
20. Message Area	2-8
21. Title	2-8
Rear Panel Features and Connectors	2-9

1. External Reference Input	2-9
2. Internal Reference Output	2-10
3. External Program RUN/CONT Input	2-10
4. I/O Port	2-10
5. Power	2-10
6 GPIB Interface	2-10
7. mini-DIN Keyboard Connector	2-10
8. External Trigger Input	2-10
9. Reference Oven Output (Option 1D5 Only)	2-10
10. Video Port	2-10
11. Printer Port	2-10
I/O Port	2-11
Test Station	2-13
1. Cable	2-13
2. Test Fixture Mounting Posts	2-13
3. Test Fixture Mounting Screws	2-13
4. Test Head Connectors	2-13
5. Heat Sink	2-14
6. Test Station Mounting Screws	2-14
Test Heads	2-15
1. Connectors	2-15
2. APC-7® Connector	2-15
3. Knobs	2-15
High Impedance Measurement Test Head	2-15
Low Impedance Measurement Test Head (Option 012 only)	2-16
High Temperature High Impedance Test Head (Option 013 only)	2-16
High Temperature Low Impedance Test Head (Option 014 only)	2-16
3. Active Channel Block	
Chan 1 and Chan 2	3-2
Active Channel	3-2
Coupling Channels	3-2
Stimulus Coupling	3-2
Marker Coupling	3-2
4. Entry Block	
Numeric Keypad	4-2
Terminator Keys	4-2
Knob	4-2
↑ and ↓	4-2
Entry Off	4-3
Back Space	4-3

5. Measurement Block

Meas	5-3
Impedance Measurement Menu	5-9
Complex Impedance Measurement Menu	5-11
Dual Parameter Menu	5-12
Impedance Fixture Menu (No option 002)	5-14
Impedance Fixture Menu (Option 002 only)	5-15
Permittivity Measurement Menu (Option 002 only)	5-17
Complex Permittivity Measurement Menu (Option 002 only)	5-19
Dual Parameter Menu (Dielectric Material Measurement)	5-20
Dielectric Material Fixture Menu (Option 002 only)	5-21
Dielectric Material Size Menu (Option 002 only)	5-22
Permeability Measurement Menu (Option 002 only)	5-23
Complex Permeability Measurement Menu (Option 002 only)	5-25
Dual Parameter Menu (Magnetic Material Measurement)	5-26
Magnetic Material Fixture Menu (Option 002 only)	5-27
Magnetic Material Size Menu (Option 002 only)	5-29
Format	5-30
Format Menu	5-30
User Trace Format Menu	5-31
Display	5-32
Display Menu	5-33
Display Allocation Menu	5-36
Data Math Menu	5-38
Equivalent Circuit Menu	5-40
Adjust Display Menu	5-42
Color Adjust Menu	5-44
Label Menu	5-45
Title menu	5-46
User Trace Display Menu	5-47
Scale Ref	5-49
Scale Reference Menu	5-49
User Trace Scale Menu	5-51
Bw/Avg	5-52
Averaging Menu	5-52
Cal	5-54
Calibration Menu	5-55
Fixture Compensation Menu (for Impedance Measurement)	5-57
Fixture Compensation Menu (for Permittivity Measurement)	5-58
Fixture Compensation Menu (for Permeability Measurement)	5-59
Calkit Menu	5-60
CAL KIT	5-60
Compen Kit Menu (for Impedance Measurement Fixture)	5-62
Compen Kit Menu (for Permittivity Measurement Fixture)	5-64
Port Extension Menu	5-66

6. Stimulus Block	
Sweep	6-3
Sweep Menu	6-4
List Menu	6-7
Segment Menu	6-9
Source	6-10
Source Menu	6-10
Trigger	6-12
Trigger Menu	6-12
Start Stop Center Span	6-14
7. Marker Block	
Marker	7-3
Marker Menu	7-4
Delta mode menu	7-6
Marker⇒	7-7
Marker→ menu	7-7
Search	7-10
Search Menu	7-11
Target Menu	7-12
Peak Menu	7-13
Search Range Menu	7-15
Widths Menu	7-16
Utility	7-18
Utility Menu	7-18
Marker Function	7-20
Three Types of Markers	7-20
Marker Value	7-20
X-axis Value to be Displayed	7-20
Stimulus Value	7-20
Time	7-20
Relaxation Time ($1/2\pi f$)	7-20
Marker Level Monitor	7-21
OSC level monitor value	7-21
Continuous/Discrete Mode	7-21
Marker on the Data Trace or on the Memory Trace	7-21
ΔMode	7-21
Marker Search Function	7-22
Width Function	7-22
Width Value	7-23
Peak Definition	7-26
Peak Definition	7-26
8. Instrument State Block	
System	8-3
System Menu	8-4
Instrument BASIC menu	8-6
Program Menu	8-9
Memory Partition Menu	8-10
Clock Menu	8-11
Beeper Menu	8-13
Limit Test Menu	8-14
Limit Line Entry Menu	8-17
Local	8-19
Local Menu	8-19

Preset	8-21
Copy	8-22
Copy Menu	8-23
Print Setup Menu	8-26
Copy Limit Test Menu	8-28
Copy List Sweep Menu	8-28
Screen Menu	8-29
Save	8-30
Save Menu	8-32
Define Save Data Menu	8-35
Re-Save File Menu	8-36
Purge File Menu	8-37
Purge Yes No Menu	8-37
Initialize Yes No Menu	8-38
Recall	8-39
Recall Menu	8-39
Limit Line Concept	8-40
How Limit Lines are Entered	8-40
Turning Limit Lines and Limit Testing On and Off	8-41
Segment Entering Order	8-42
Saving the Limit Line Table	8-42
Offsetting the Stimulus or Amplitude of the Limit Lines	8-42
Supported Display Formats	8-42
Use a Sufficient Number of Points or Errors May Occur	8-42
Displaying or Printing Limit Test Data	8-42
Results of Printing the Display with Limit Lines ON	8-43
GPIB	8-44
What is GPIB?	8-44
How GPIB Works	8-44
Talker	8-44
Listener	8-44
Controller	8-45
GPIB Requirements	8-45
Analyzer GPIB Capabilities	8-45
Bus Mode	8-46
System Controller	8-46
Addressable	8-46
Setting Addresses	8-47
Saving and Recalling Instrument States and Data	8-48
Storage Devices	8-48
Disk Requirements	8-48
Disk Formats	8-48
Memory disk Capacity	8-48
Copy Files Between the memory disk and the floppy Disk	8-48
File Types and Data Groups	8-48
File Types	8-48
Data Groups	8-49
Graphics Images (GRAPHICS)	8-49
File Type and Data Group Combinations	8-49
File Names	8-50
Valid Characters for File Names	8-50
Suffixes (LIF) and Extensions (DOS)	8-50
Auto Recall Function	8-50

File Structure of Internal Data Arrays File for Binary	
Files	8-51
File Header	8-51
Data Group	8-52
File Structure of Internal Data Arrays File for ASCII	
File	8-56
Status Block	8-56
Data Block	8-56
File Structure for Single Channel and Dual Channel . .	8-58

9. Analyzer Features

Introduction	9-1
System Overview	9-1
Data Processing	9-2
Overview	9-2
Data Processing Flow	9-3
AD converter (ADC)	9-3
Digital Filter	9-3
Ratio Processing	9-4
Fixed Point Calibration Coefficient Arrays and User Defined Point Calibration Coefficient Arrays	9-4
Calibration Coefficient Interpolation	9-4
Calibration Coefficient Arrays	9-4
Error Collection	9-4
Averaging	9-4
Raw Data Arrays	9-4
Port Extension	9-5
Fixture Compensation Coefficient Arrays	9-5
Fixed Point Fixture Compensation Coefficient Arrays and User Defined Point Fixture Compensation Coefficient Arrays	9-5
Compensation Coefficient Interpolation	9-5
Fixture Compensation	9-5
Data Arrays	9-5
Memory Arrays	9-5
Format	9-6
Data Math	9-6
Data Trace Arrays	9-6
Memory Trace Arrays	9-6
Scaling	9-6

10. Options and Accessories

Introduction	10-1
Options Available	10-1
Option 001 Add dc bias	10-1
Option 002 Add material measurement firmware	10-1
Option 011 Delete high impedance test head	10-1
Option 012 Add low impedance test head	10-1
Option 013 Add high temperature high impedance test head	10-1
Option 014 Add high temperature low impedance test head	10-1
Option 0BW Add Service Manual	10-2
Option 1D5 Add high stability frequency reference	10-2
Option 1A2 Keyboard less	10-2

Option 1CM Rack mount kit	10-2
Option 1CN Handle Kit	10-2
Option 1CP Rack mount and handle kit	10-2
Measurement accessories available	10-3
16191A Side electrode SMD test fixture	10-3
16192A Parallel electrode SMD test fixture	10-3
16193A Small side electrode SMD test fixture	10-3
16194A High temperature component fixture	10-3
16453A Dielectric material test fixture	10-3
16454A magnetic material test fixture	10-3
16091A Coaxial termination fixture set	10-3
16092A Spring clip test fixture	10-4
16093A/B Binding post test fixtures	10-4
16094A Probe test fixture	10-4
System accessories available	10-4
System rack	10-4
Printer	10-4
GPIB cable	10-5
Service Accessories Available	10-5
Collet removing tool (Agilent part number 5060-0236) .	10-5
Collet removing tool guide (Agilent part number 04291-21002)	10-5
6-Slot collet (Agilent part number 85050-20001)	10-5

11. Impedance Measurement Basics

Impedance parameters	11-3
Impedance (Z)	11-3
Admittance (Y)	11-4
Reflection Coefficient (Γ)	11-5
Series and Parallel Circuit Models	11-6
Parallel-Series Equivalent Circuit Conversion	11-6
Selecting Circuit Mode of Capacitance	11-7
Small Capacitance	11-7
Large Capacitance	11-8
Selecting Circuit Mode of Inductance	11-8
Large Inductance	11-8
Small Inductance	11-9
Smith Chart	11-10
Calibration Concepts	11-12
OPEN SHORT LOAD Calibration	11-12
Ideal Measurement Circuit	11-12
General Impedance Measurement Schematic	11-13
Low Loss Capacitor Calibration	11-14
Port Extension	11-16
Fixture Compensation	11-19
Actual Measuring Circuit	11-19
Residual Parameter Effects	11-19
Characteristics of Test Fixture	11-20
Electrical Length of Coaxial Coupling Terminal Section	11-20
Elimination of Electrical Length Effects in Test Fixture	11-20
Residual and Stray Parameters of Contact Electrode Section	11-20

Elimination of Residual Parameter Effects in Test Fixture (Fixture Compensation)	11-21
Compensation Coefficient for Each Compensation	11-22
OPEN Compensation	11-22
SHORT Compensation	11-22
LOAD Compensation	11-23
OPEN-SHORT Compensation	11-23
OPEN-LOAD Compensation	11-24
SHORT-LOAD Compensation	11-24
OPEN-SHORT-LOAD Compensation	11-24
Permittivity Measurements	11-26
Complex Permittivity	11-26
Characteristics of Test Fixture	11-27
Edge Effect	11-27
Residual Parameter	11-28
Permeability Measurements	11-29
Complex Permeability	11-30
Characteristics of the Test Fixture	11-31
Residual Parameter	11-31
Elimination of Residual Impedance Effects in the Test Fixture (SHORT Fixture Compensation)	11-31
Impedance Parameter Value Displayed for Magnetic Material Measurement	11-32

12. 4291B

RF Impedance/Material Analyzer

Technical

Data

Measurement Parameter	12-1
Impedance parameters	12-1
Stimulus Characteristics	12-1
Frequency Characteristics	12-1
Source Characteristics	12-1
Sweep Characteristics	12-3
Calibration/Compensation	12-4
Measurement Accuracy	12-5
Specification for Option 013 and 014 High Temperature Test Heads	12-11
Frequency Characteristics	12-11
Source Characteristics	12-11
Basic Measurement Accuracy	12-12
Typical Effects of Temperature Drift on Measurement Accuracy	12-16
Operation Conditions of the Test Head	12-18
Dimensions of High Temperature Test Head	12-18
Display	12-19
Data Storage	12-19
GPIB	12-19
Printer parallel port	12-20
General Characteristics	12-20
Input and Output Characteristics	12-20
Operation Conditions	12-21
Non-operation conditions	12-21
Others	12-21
External program Run/Cont input	12-22

Specifications for Option 1D5 High Stability Frequency	
Reference	12-22
Reference Oven Output	12-22
Supplemental Characteristics for Option 002 Material	
Measurement	12-23
Measurement Frequency Range	12-23
Measurement Parameter	12-23
Permittivity parameters	12-23
Permeability parameters	12-23
Typical Measurement Accuracy	12-23
Option 002 Material Measurement Accuracy with Option	
013 and 014 High Temperature Test Head (Typical)	12-39
Dielectric Material Measurement Accuracy with High	
Temperature Test Head (Typical)	12-39
Typical Effects of Temperature Drift on Dielectric	
Material Measurement Accuracy	12-40
Magnetic Material Measurement Accuracy with High	
Temperature Test Head (Typical)	12-45
Typical Effects of Temperature Drift on Magnetic	
Material Measurement Accuracy	12-46
Furnished Accessories	12-51

A. Manual Changes

Introduction	A-1
Manual Changes	A-1
Serial Number	A-2

B. Input Range and Default Setting

Meas	B-2
Format	B-2
Display	B-3
Scale Ref	B-4
Bw/Avg	B-6
Cal	B-6
Cal (ϵ)	B-7
Cal (μ)	B-7
Sweep	B-8
Source	B-8
Trigger	B-8
Start, Stop, Center, Span	B-9
Marker	B-9
Marker→	B-10
Search	B-10
Utility	B-10
System	B-11
Local	B-12
Copy	B-12
Save	B-12

C. Option 013, 014 Temperature Coefficient Measurement

 Introduction	C-1
Setup and Installation Guide	C-2
Required Equipment	C-2
Equipment Setup	C-2
Quick Start	C-4
Calibration	C-4
Setting the Test Fixture	C-4
Fixture Compensation	C-4
Saving Status File	C-8

Messages

Index

Figures

1-1. 4291B System Overview	1-2
1-2. Test Fixtures	1-2
1-3. Material Test Fixtures for Option 002	1-3
1-4. High Temperature Test Heads and High Temperature Test Fixtures for Option 013/014	1-3
2-1. Analyzer Front Panel	2-1
2-2. Screen Display (Single Channel, Cartesian Format)	2-4
2-3. Analyzer Rear Panel	2-9
2-4. Pin Assignment of I/O Port	2-11
2-5. Circuit of I/O Port	2-12
2-6. Test Station	2-13
2-7. Keeping Space Around the Heat Sink	2-14
2-8. Dimensions of Test Station	2-14
2-9. Test Heads	2-15
3-1. Active Channel Keys	3-1
4-1. Entry Block	4-1
5-1. Measurement Block	5-1
5-2. Softkey Menu Accessed from the Meas Key for Impedance Measurement	5-3
5-3. Softkey Menu Accessed from the Meas Key for Permittivity Measurement	5-4
5-4. Softkey Menu Accessed from the Meas Key for Permeability Measurement	5-5
5-5. Softkey Menu Accessed from the Meas Key for Impedance Measurement (when Smith/Polar/Admittance or Complex-Plane Format is selected)	5-6
5-6. Softkey Menu Accessed from the Meas Key for Permittivity Measurement (when Smith/Polar/Admittance or Complex-Plane Format is selected)	5-7
5-7. Softkey Menu Accessed from the Meas Key for Permeability Measurement (when Smith/Polar/Admittance or Complex-Plane Format is selected)	5-8
5-8. Impedance Measurement Menu	5-9
5-9. Complex Impedance Measurement Menu	5-11
5-10. Dual Parameter Menu	5-12
5-11. Impedance Fixture Menu (No option 002)	5-14
5-12. Impedance Fixture Menu (Option 002 only)	5-15
5-13. Permittivity Measurement Menu (Option 002 only)	5-17
5-14. Complex Permittivity Measurement Menu (Option 002 only)	5-19
5-15. Dual Parameter Menu (Dielectric Material Measurement)	5-20
5-16. Dielectric Material Fixture Menu (Option 002 only)	5-21

5-17. Dielectric Material Size Menu (Option 002 only)	5-22
5-18. Dielectric Material Size	5-22
5-19. Permeability Measurement Menu (Option 002 only)	5-23
5-20. Complex Permeability Measurement Menu (Option 002 only)	5-25
5-21. Dual Parameter Menu (Magnetic Material Measurement)	5-26
5-22. Magnetic Material Fixture Menu (Option 002 only)	5-27
5-23. Magnetic Material Size Menu (Option 002 only)	5-29
5-24. Magnetic Material Size	5-29
5-25. Format Menu	5-30
5-26. User Trace Format Menu	5-31
5-27. Softkey Menu Accessed from Display Key	5-32
5-28. Display Menu	5-33
5-29. Display Allocation Menu	5-36
5-30. Display Allocations	5-37
5-31. Data Math Menu	5-38
5-32. Equivalent Circuit Menu	5-40
5-33. Adjust Display Menu	5-42
5-34. Color Adjust Menu	5-44
5-35. Label Menu	5-45
5-36. Title Menu	5-46
5-37. User Trace Display Menu	5-47
5-38. Scale Reference Menu	5-49
5-39. User Trace Scale Menu	5-51
5-40. Averaging Menu	5-52
5-41. Softkey Menu Accessed from Cal key	5-54
5-42. Calibration Menu	5-55
5-43. Fixture Compensation Menu	5-57
5-44. Fixture Compensation Menu (for Permittivity Measurement)	5-58
5-45. Fixture Compensation Menu (for Permeability Measurement)	5-59
5-46. Calkit Menu	5-60
5-47. Calibration Standard Model	5-61
5-48. Compen Kit Menu (for Impedance Measurement Fixture)	5-62
5-49. Parameters of OPEN, SHORT, and LOAD for the Impedance Fixture Compensation	5-63
5-50. Compen Kit Menu (for Permittivity Measurement Fixture)	5-64
5-51. Parameters of LOAD for the Permittivity Fixture Compensation	5-65
5-52. Port Extension Menu	5-66
6-1. Stimulus Block	6-1
6-2. Softkey Menus Accessed from the Sweep Key	6-3
6-3. Sweep Menu	6-4
6-4. Sweep Delay Time and Point Delay Time	6-5
6-5. List Menu	6-7
6-6. Segment Menu	6-9
6-7. Softkey Menus Accessed from the Source Key	6-10
6-8. Softkey Menus Accessed from the Trigger Key	6-12
7-1. Marker Block	7-1
7-2. Softkey Menus Accessed from the Marker Key	7-3
7-3. Marker Menu	7-4
7-4. Delta Mode Menu	7-6

7-5. Marker→ Menu	7-7
7-6. Softkey Menus Accessed from the Search Key	7-10
7-7. Search Menu	7-11
7-8. Target Menu	7-12
7-9. Peak Menu	7-13
7-10. Search Range Menu	7-15
7-11. Widths Menu	7-16
7-12. Utility Menu	7-18
7-13. Bandwidth Search Example	7-23
7-14. Q Measurement Examples	7-25
7-15. Peak Definition	7-26
8-1. Instrument State Block	8-1
8-2. Softkey Menus Accessed from the System Key	8-3
8-3. System Menu	8-4
8-4. Instrument BASIC Menu	8-6
8-5. Program Menu	8-9
8-6. Memory Partition Menu	8-10
8-7. Clock Menu	8-11
8-8. Beeper Menu	8-13
8-9. Limit Test Menu	8-14
8-10. Limit Line Entry Menu	8-17
8-11. Local Menu	8-19
8-12. Softkey Menus Accessed from the Copy Key	8-22
8-13. Copy Menu	8-23
8-14. Print Setup Menu	8-26
8-15. Copy Limit Test Menu	8-28
8-16. Copy List Sweep Menu	8-28
8-17. Screen Menu	8-29
8-18. Softkey Menus Accessed from the Save Keys	8-30
8-19. Save Menu	8-32
8-20. Define Save Data Menu	8-35
8-21. Re-Save File Menu	8-36
8-22. Purge File Menu	8-37
8-23. Purge Yes No Menu	8-37
8-24. Initialize Yes No Menu	8-38
8-25. Recall Menu	8-39
8-26. The Concept of Segments as a Point between Two Sets of Limit Lines	8-40
8-27. Analyzer Bus Concept	8-46
8-28. File Header Structure	8-51
8-29. RAW, DATA, and DATA-TRACE Data Group Structure	8-52
8-30. CAL Data Group Structure	8-53
8-31. MEMORY and MEMORY TRACE Data Group Structure	8-54
8-32. User Trace Data Group Structure	8-55
9-1. Analyzer Simplified Block Diagram	9-1
9-2. Data Processing	9-3
11-1. Definition of Impedance	11-3
11-2. Vector Representation of Admittance	11-5
11-3. Small Capacitance Circuit Mode Selection	11-7
11-4. Large Capacitance Circuit Mode Selection	11-8
11-5. Large Inductance Circuit Mode Selection	11-9
11-6. Small Inductance Circuit Mode Selection	11-9
11-7. Smith Chart	11-10
11-8. Impedance Read-out	11-11
11-9. Phase Shift by Transmission Line	11-11

11-10. Measurement Circuits for I-V Method	11-12
11-11. General Schematic for Impedance Measurement Using Two Vector Voltmeters	11-13
11-12. Modifying the Standard Value of a 50 Ω LOAD using a Low-Loss Air-Capacitor	11-15
11-13. Port Extension	11-16
11-14. Residual Parameters in the Circuit	11-19
11-15. Characteristics of Test Fixture	11-20
11-16. Test Fixture Represented by the F matrix of a Two Terminal Pair Network	11-21
11-17. Schematic Electrode Structure of the 16453A	11-26
11-18. Material has some loss	11-26
11-19. Edge Effect	11-27
11-20. Basic Relationship of Magnetic Flux Density, Magnetic Flux, and Current	11-29
11-21. Schematic Fixture Structure of 16454A	11-29
11-22. Material Has Loss	11-30
11-23. Residual Impedance of the 16454A	11-31
12-1. DC Voltage and Current Level Range (Typical)	12-3
12-2. Impedance Measurement Accuracy Using High Impedance Test Head (@ Low OSC Level)	12-7
12-3. Impedance Measurement Accuracy Using High Impedance Test Head (@ High OSC Level)	12-7
12-4. Impedance Measurement Accuracy Using Low Impedance Test Head (@ Low OSC Level)	12-8
12-5. Impedance Measurement Accuracy Using Low Impedance Test Head (@ High OSC Level)	12-8
12-6. Typical Q Measurement Accuracy (when open/short/50 Ω /low-loss-capacitor calibration are done)	12-10
12-7. Impedance Measurement Accuracy Using High Temperature High Impedance Test Head (@ Low OSC Level)	12-14
12-8. Impedance Measurement Accuracy Using High Temperature High Impedance Test Head (@ High OSC Level)	12-14
12-9. Impedance Measurement Accuracy Using High Temperature Low Impedance Test Head (@ Low OSC Level)	12-15
12-10. Impedance Measurement Accuracy Using High Temperature Low Impedance Test Head (@ High OSC Level)	12-15
12-11. Typical Frequency Characteristics of Temperature Coefficient Using High Temperature High Impedance Test Head	12-17
12-12. Typical Frequency Characteristics of Temperature Coefficient Using High Temperature Low Impedance Test Head	12-17
12-13. Dimensions of High Temperature Test Head	12-18
12-14. Trigger Signal	12-20
12-15. I/O Port Pin Assignment	12-22
12-16. Typical Permittivity Measurement Accuracy (@thickness=0.3 mm)	12-25
12-17. Typical Permittivity Measurement Accuracy (@thickness=1 mm)	12-25

12-18. Typical Permittivity Measurement Accuracy (@thickness=3 mm)	12-26
12-19. Typical Dielectric Loss Tangent ($\tan\delta$) Measurement Accuracy (@thickness=0.3 mm)	12-27
12-20. Typical Dielectric Loss Tangent ($\tan\delta$) Measurement Accuracy (@thickness=1 mm)	12-28
12-21. Typical Dielectric Loss Tangent ($\tan\delta$) Measurement Accuracy (@thickness=3 mm)	12-29
12-22. Typical Permittivity Measurement Accuracy (ϵ_r v.s. Frequency, @thickness=0.3 mm)	12-30
12-23. Typical Permittivity Measurement Accuracy (ϵ_r v.s. Frequency, @thickness=1 mm)	12-30
12-24. Typical Permittivity Measurement Accuracy (ϵ_r v.s. Frequency, @thickness=3 mm)	12-31
12-25. Typical Permeability Measurement Accuracy (@F* = 0.5)	12-31
12-26. Typical Permeability Measurement Accuracy (@F* = 3)	12-32
12-27. Typical Permeability Measurement Accuracy (@F* = 10)	12-32
12-28. Typical Permeability Loss Tangent ($\tan\delta$) Measurement Accuracy (@F* = 0.5)	12-33
12-29. Typical Permeability Loss Tangent ($\tan\delta$) Measurement Accuracy (@F* = 3)	12-34
12-30. Typical Permeability loss Tangent ($\tan\delta$) Measurement Accuracy (@F* = 10)	12-35
12-31. Typical Permeability Measurement Accuracy (μ_r v.s. Frequency, @F* = 0.5)	12-36
12-32. Typical Permeability Measurement Accuracy (μ_r v.s. Frequency, @F* = 3)	12-36
12-33. Typical Permeability Measurement Accuracy (μ_r v.s. Frequency, @F* = 10)	12-37
12-34. Typical Frequency Characteristics of Temperature Coefficient of ϵ_r' and Loss Tangent Accuracy (Thickness=0.3 mm)	12-42
12-35. Typical Frequency Characteristics of Temperature Coefficient of ϵ_r' and Loss Tangent Accuracy (Thickness=1 mm)	12-43
12-36. Typical Frequency Characteristics of Temperature Coefficient of ϵ_r' and Loss Tangent Accuracy (Thickness=3 mm)	12-44
12-37. Typical Frequency Characteristics of Temperature Coefficient of μ_r' and Loss Tangent Accuracy (F* = 0.5)	12-48
12-38. Typical Frequency Characteristics of Temperature Coefficient of μ_r' and Loss Tangent Accuracy (F* = 3)	12-49
12-39. Typical Frequency Characteristics of Temperature Coefficient of μ_r' and Loss Tangent Accuracy (F* = 10)	12-50
A-1. Serial Number Plate	A-2
C-1. Equipment Setup	C-2
C-2. Test Head and Test Stand Setup	C-3
C-3. 16194A Connection	C-4

Tables

5-1. Equivalent Circuit Selection Guide	5-41
8-1. List Value Format	8-24
8-2. Contents of ASCII Files	8-57
8-3. Data Groups and Data Array Names	8-58
10-1. Supported Printers and Printing Modes	10-5
11-1. Parallel/Series Circuit Model and Measurement Parameter	11-6
11-2. Dissipation Factor Equations and Parallel-Series Equivalent Circuit Conversion	11-7
12-1. Z_s and Y_o when High Impedance Test Head is used	12-6
12-2. Z_s and Y_o when Low Impedance Test Head is used	12-6
12-3. Z_s and Y_o when High Impedance Test Head is used	12-13
12-4. Z_s and Y_o when Low Impedance Test Head is used	12-13
12-5. Applicable Dielectric Material Size Using with 16453A	12-38
12-6. Applicable Magnetic Material Size Using with 16454A	12-38
A-1. Manual Changes by Serial Number	A-1
A-2. Manual Changes by Firmware Version	A-1

Introduction

Introduction

This chapter provides an overview of the 4291B system and descriptions of the main features of the analyzer (also referred to as the main frame). The system includes the analyzer, test station, test heads, fixtures, and keyboard. The analyzer features include the front and rear panels and the six key blocks. The front and rear panel sections provide information on the input/output connectors, the LCD, and other panel features. The six key block sections describe the keys and their associated menus and how they function together.

System Overview

The 4291B system is shown in Figure 1-1, Figure 1-2, and Figure 1-3.

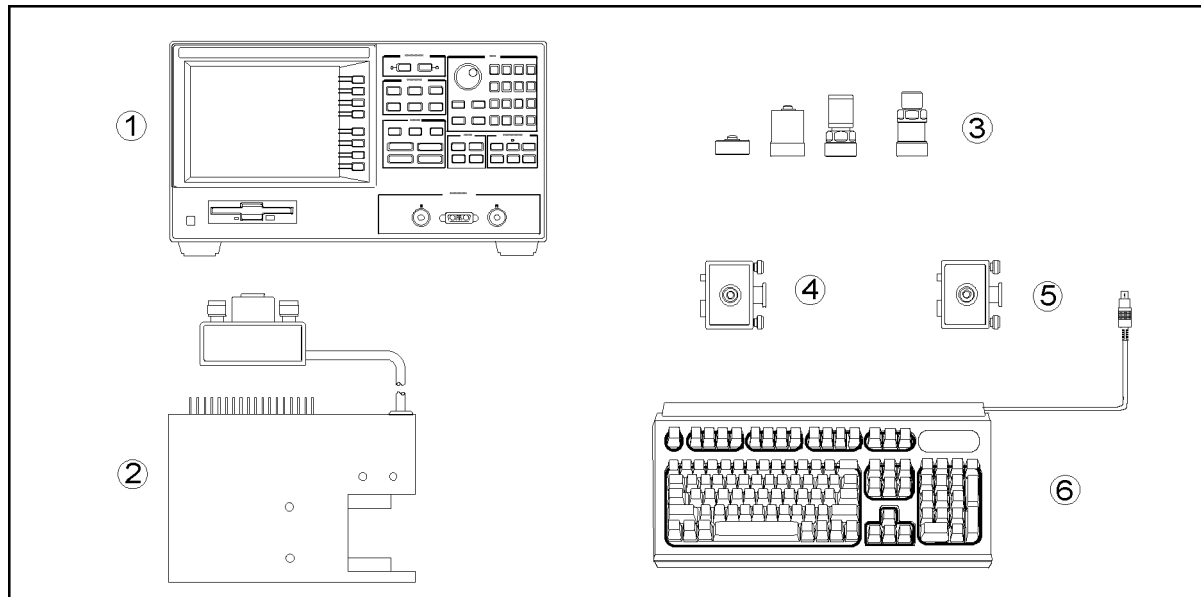

CE001001

Figure 1-1. 4291B System Overview

1. Main frame
2. Test station (furnished with the main frame)
3. Cal kit (furnished with the main frame)
4. High impedance test head (furnished with the main frame)
5. Low impedance test head (furnished with option 012)
6. mini-DIN Keyboard

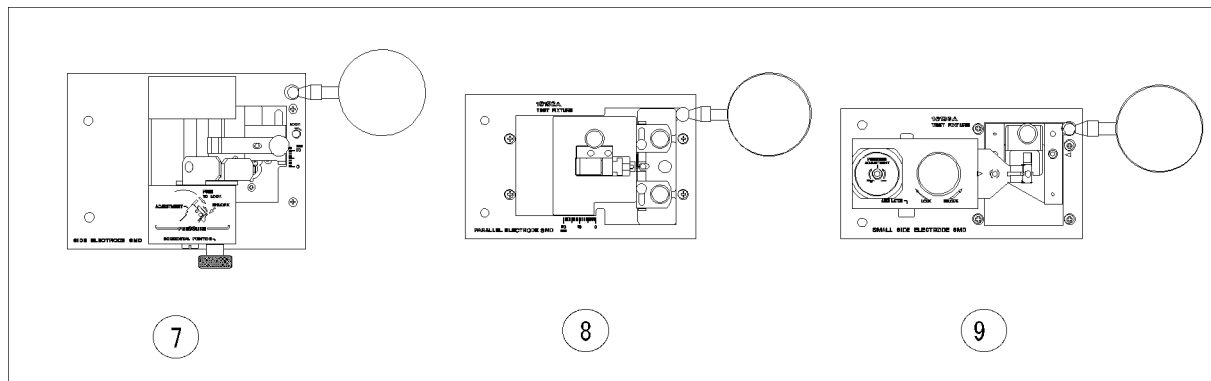

CS001002

Figure 1-2. Test Fixtures

7. 16191A Component test fixture (optional)
8. 16192A Component test fixture (optional)
9. 16193A Component test fixture (optional)

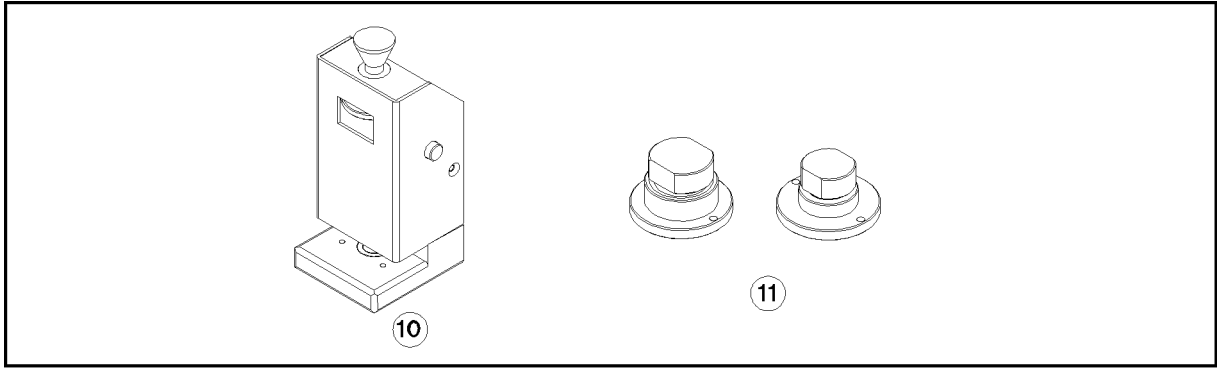

CE001003

Figure 1-3. Material Test Fixtures for Option 002

- 10. 16453A Dielectric material test fixture (optional)
- 11. 16454A Magnetic material test fixture (optional)

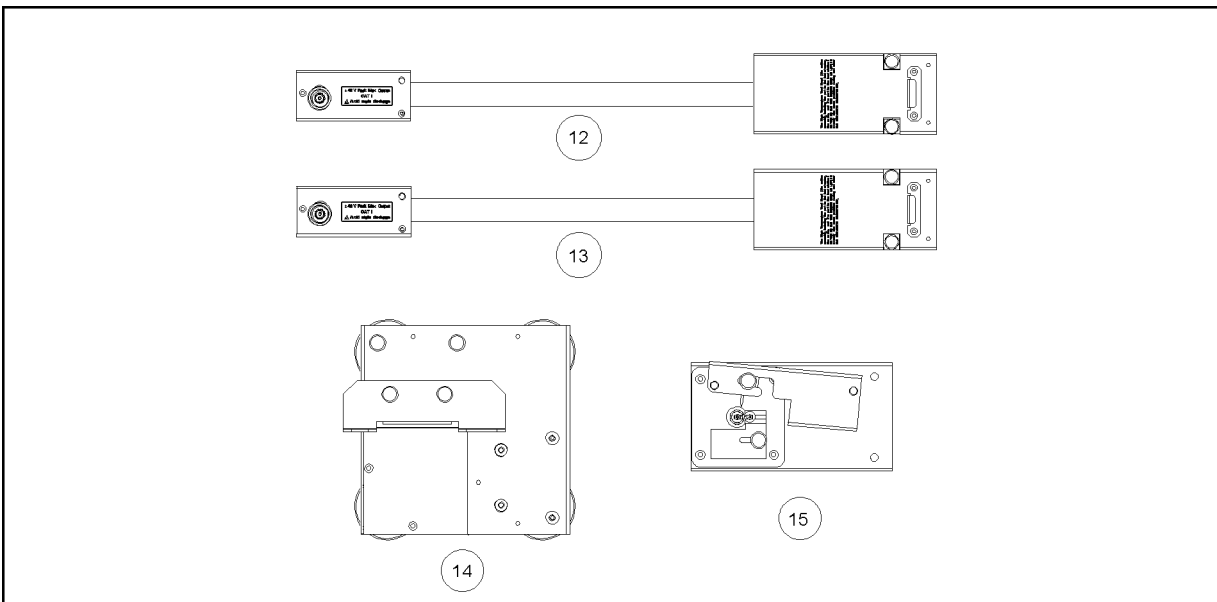

CE001004

**Figure 1-4.
High Temperature Test Heads and High Temperature Test Fixtures for Option 013/014**

- 12. High temperature high impedance test head (furnished with option 013)
- 13. High temperature low impedance test head (furnished with option 014)
- 14. Fixture Stand (furnished with option 013 and option 014)
- 15. 16194A High temperature component test fixture (optional)

Note



For more information on options and accessories available, see Chapter 2 and manuals furnished with each accessory. Also other options and accessories are available, see Chapter 10 for details.

Analyzer features

The following sections describe the analyzer's features. Individual chapters following this chapter describe each block of controls in more detail.

Front and Rear Panels

Analyzer functions are activated from the front panel by using front panel hardkeys or softkeys. Measurement results are displayed on the LCD (which also displays the measurement conditions and the instrument status). The front panel has input, output, and control ports to connect to the test station and a floppy disk drive to store data and instrument status.

The rear panel has input and output connectors to control the analyzer from an external controller or to control external devices from the analyzer. The rear panel also has a connector used to control a BASIC program, a connector for an external keyboard, and a parallel I/O port controlled by the program.

For more information, see Chapter 2.

ACTIVE CHANNEL Block



The analyzer has two channels for independent measurement of parameters and display of data. This block has two keys that select the active channel. Once an active channel is selected, you can control it using the front panel keys and display its trace and data annotations. If you want to use the other channel, you must select the new channel before you make any other changes. For more information, see Chapter 3.

ENTRY Block

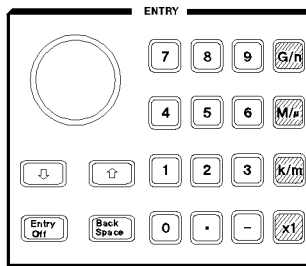

This block provides the numerical and units keypad, the knob, and the step keys. These controls are used in combination with other keys to enter or change numeric data.

For more information, see Chapter 4.

MEASUREMENT Block

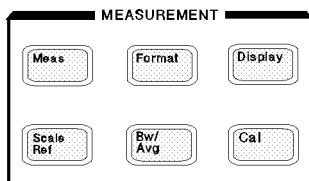

This block controls the measurement and display functions. Each key provides access to softkey menus.

Because the measurement functions are different for impedance, permittivity ϵ , and permeability μ measurements, the menus accessed from the **Meas** and **Cal** keys are different for each measurement of operation.

Meas

Provides access to a series of menus used to select the parameters to be measured. This menu is also used to select fixtures to be used for material (ϵ and μ) measurements.

Format

Displays the menu used to select the display format of the data. Various rectangular and polar formats are available

for display of measurement parameters selected by **Meas** key.

- Display** Provides access to a series of menus used for instrument state and active channel display functions. These menus include dual channel display (overlaid or split), definitions of the displayed active channel trace in terms of the mathematical relationship between data and trace memory, display intensity, color selection, active channel display title, frequency blanking, and equivalent circuit function.
- Scale Ref** Displays the menu used to modify the axis scales and the reference line value.
- Bw/Avg** Provides access to two different noise reduction techniques: sweep-to-sweep averaging, and on-point averaging.
- Cal** Provides access to a series of menus that implement the calibration and fixture compensation procedures.

For more information, see Chapter 5.

STIMULUS Block

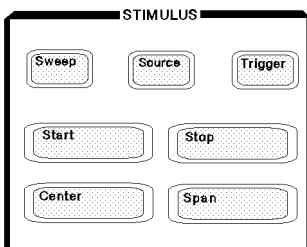

This block defines the sweep range, and controls the trigger function, test signal and DC bias source.

- Sweep** Provides access to a series of menus used for selecting the sweep type, editing the list sweep table, specifying the number of points to be displayed, and specifying the delay time.
- Source** Displays the menu used to control the test signal, and DC bias.
- Trigger** Provides access to a series of menus used for selecting trigger mode and trigger source.

Start, **Stop**, **Center**, and **Span**

Used to specify frequency or power range of the stimulus.

For more information, see Chapter 6.

MARKER Block

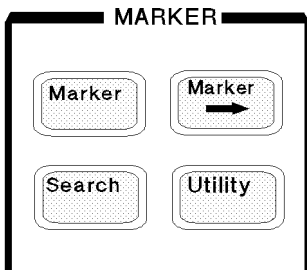

This block displays the marker on the screen and controls the marker function.

- Marker** Displays the marker and provides access to a series of menus used for selecting the marker mode and displaying the sub-markers and the Δ marker.
- Marker→** Provides access to a series of menus used for changing selected measurement parameters to the current marker value.
- Search** Displays menus used for searching the trace for a specific amplitude related point and placing the marker on that point.
- Utility** Displays a menu used for listing all marker values, calculating and displaying statistical values of the display trace, indicating the time elapsed since the sweep started, monitoring OSC or dc bias level applied to a DUT.

For more information, see Chapter 7.

INSTRUMENT STATE Block

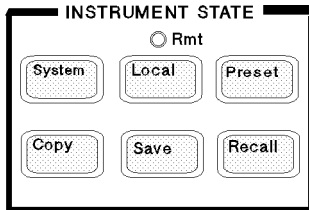

This block provides control of channel-independent system functions. These include the controller modes, real-time clock, limit line and limit testing, HP Instrument BASIC, printing, saving instrument states and trace data to a built-in disk or memory.

- System** Provides access to a series of menus used for programming HP Instrument BASIC, controlling the real-time clock and the beeper, defining the limit line table, performing limit line testing, and change memory size for HP Instrument BASIC and the memory disk.
- Local** Returns front panel control to the user from an external controller and displays a series of menus used to select the GPIB mode and modify the GPIB addresses.
- Preset** Sets the analyzer to the preset state. See Appendix B, for a listing of the preset values.
- Copy** Provides access to the menus used for controlling external printers and defining the parameters.
- Save** Provides access to the menus used for saving the instrument state and data to the floppy disk or memory disk.
- Recall** Displays the menu used to recall the contents of disk files or memory disk back into the analyzer.

For more information, see Chapter 8.

Front and Rear Panel, Test Station, and Test Heads

This chapter describes the features of the analyzer, the test station, and the test heads. It provides illustrations and descriptions of the analyzer's front panel features, the LCD and its labels, and the rear panel features and connectors. It also includes illustrations and descriptions of the Test station and test heads.

Front Panel

Analyzer functions are activated from the front panel (Figure 2-1) by using the front panel hardkeys or softkeys. In this manual, all front panel hardkeys and softkey labels are shown as **Hardkey** and **Softkey**, respectively.

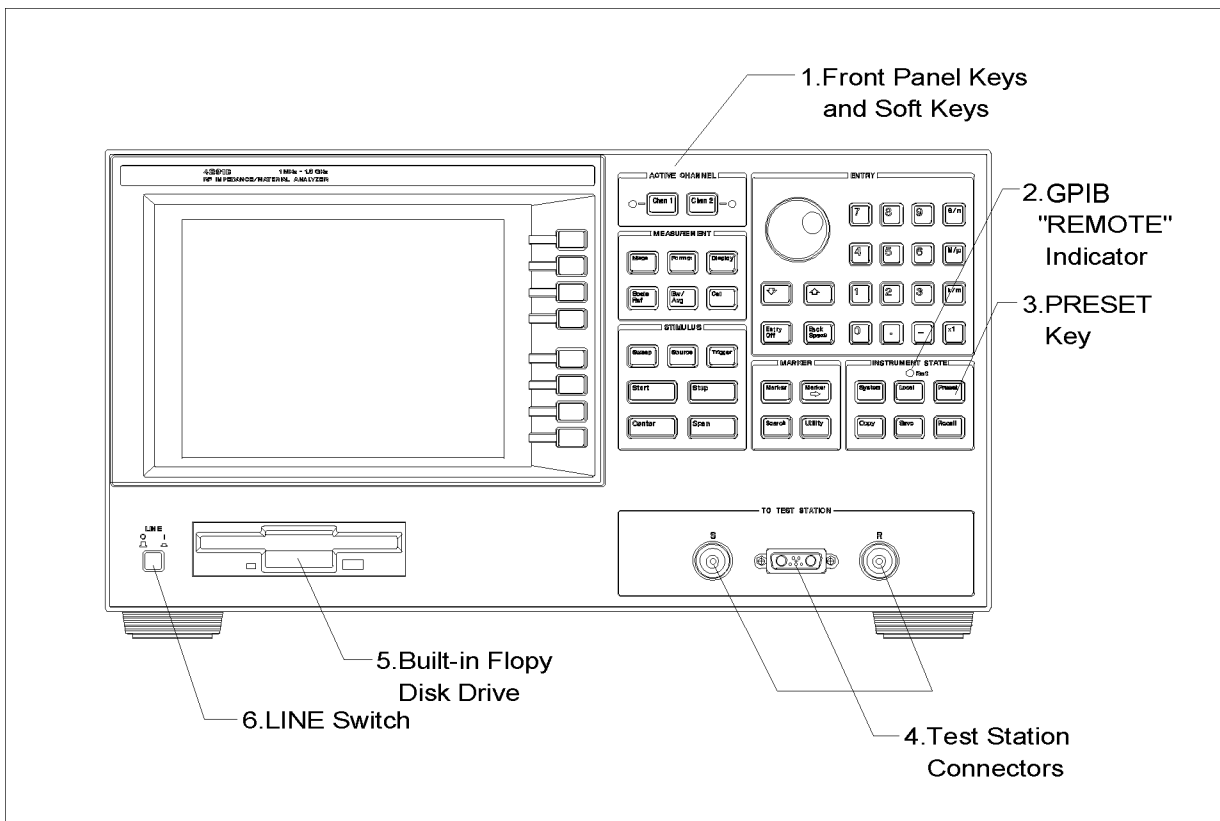

CE002001

Figure 2-1. Analyzer Front Panel

1. Front Panel Keys and Softkeys

Some of the front panel keys change instrument functions directly, and others provide access to additional functions available in softkey menus. Softkey menus are lists of up to eight related functions that can be displayed in the softkey label area at the right-hand side of the display. The eight keys to the right of the LCD are the softkeys. Pressing one of the softkeys selects the adjacent menu function. This either executes the labeled function and makes it the active function, causes instrument status information to be displayed, or presents another softkey menu.

Some of the analyzer's menus are accessed directly from front panel keys and some from other menus. For example, the sweep menu accessed by pressing the **Sweep** key presents all the sweep functions such as sweep type, number of points, and sweep time. Pressing **NUMBER of POINTS** allows the required number of points displayed per sweep to be entered directly from the number pad. **RETURN** softkeys return to previous menus. **DONE** indicates completion of a specific procedure and then returns to an earlier menu.

Usually, when a menu changes, the present active function is cleared.

Softkeys that are Joined by Vertical Lines

When several possible choices are available for a function, the softkeys are joined by vertical lines. For example, in the impedance measurement menu under the **Meas** key, the available measurement parameters are listed: **MAG(|Z|)**, **PHASE(θ_z)**, **RESIST(R)**, **REACT(X)** with a vertical line between them. Note that only one softkey can be selected at a time. When a selection has been made from the listed alternatives, that selection is underlined until another selection is made.

Softkeys That Toggle On or Off

Some softkey functions can be toggled ON or OFF, for example averaging. This is indicated in the softkey label. The current state, ON or OFF, is capitalized in the softkey label.

Example:

SWEEP AVG ON off	The word on is capitalized, showing that sweep averaging is currently on.
SWEEP AVG on OFF	The word off is capitalized, showing that sweep averaging is currently off.

Softkeys that Show Status Indications in Brackets

Some softkey labels show the current status of a function in brackets. These include simple toggle functions and status-only indicators. An example of a toggled function is the **PRINT [STANDARD]** or **PRINT [COLOR]** softkey. The **DATA MATH[]** softkey is an example of a status-only indicator, where the selected equation of the data math function is shown in brackets in the softkey label.

2. GPIB “REMOTE” Indicator

This lights when the analyzer is in the remote state.

3. Preset

This key returns the instrument to a known standard preset state from any step of any manual procedure. A complete listing of the instrument preset conditions is provided in Appendix B.

4. Test Station Connectors

The test station connects to these connectors.

5. Floppy Disk Drive

Stores the measurement data, instrument status, list sweep tables, and HP Instrument BASIC programs. The applicable disk formats are LIF (logical interchange format) and DOS (disk operating system) format.

6. LINE Switch

Turn ON/OFF the 4291B

Screen display

Displays a grid on which the measurement data is plotted the currently selected measurement traces and other information describing the measurement. Figure 2-2 shows the locations of the different information labels.

In addition to the full-screen display shown in Figure 2-2, a split display is available (see “**Display**” in Chapter 5). In this case, information labels are provided for each half of the display.

The screen can also be used as the HP Instrument BASIC display. HP Instrument BASIC uses either a full-screen display or a half-screen display below the graticule display as a text screen.

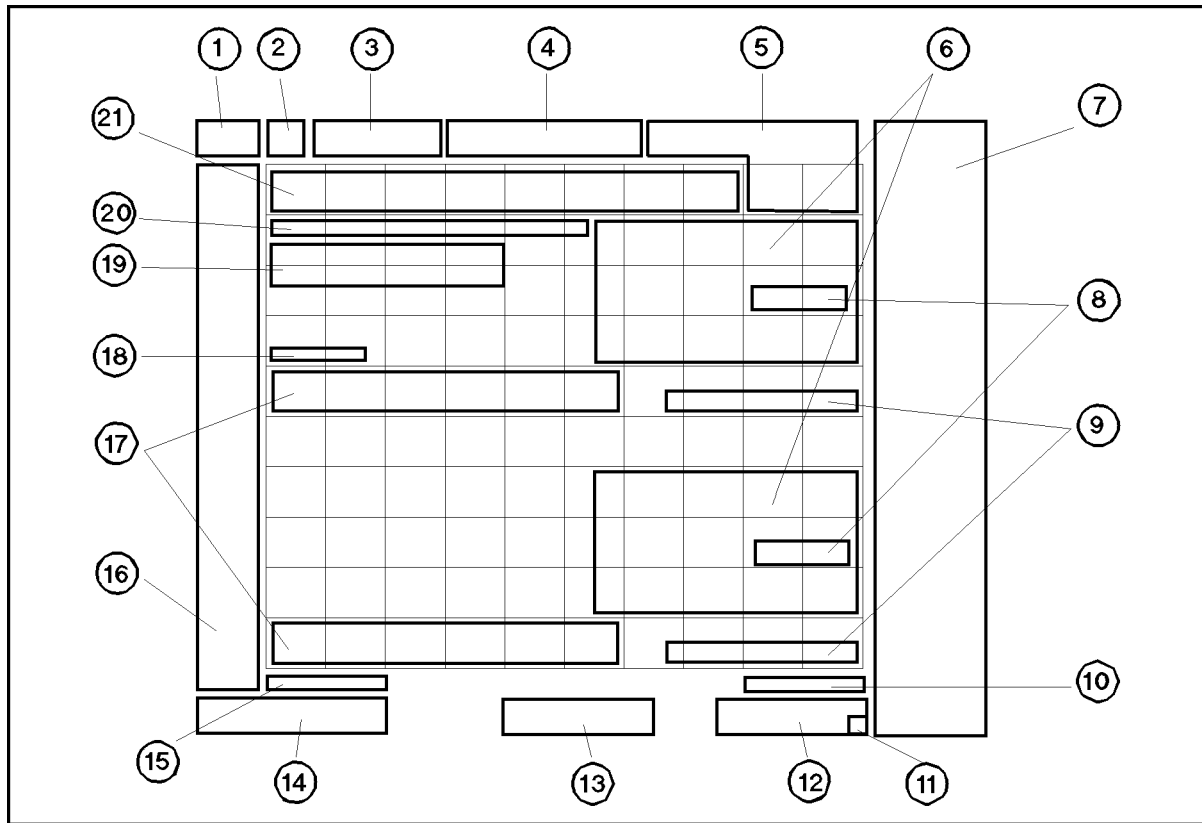

C6002002

Figure 2-2. Screen Display (Single Channel, Cartesian Format)

1. Active Channel

Displays the number of the current active channel (selected with the keys in the active channel block). If dual channel is ON with an overlaid display, both chan 1 (channel 1) and chan 2 (channel 2) appear in this area.

2. Measured parameter

Shows the measurement parameter selected using the **Meas** key.

3. Scale/Div

Displays the scale set by the **Scale Ref** key in units appropriate to the current measurement or displays top and bottom value of the graticule. When polar, Smith chart or admittance chart formats are selected, this area displays **Fsc1** and the value of the outer circle. (**Fsc1** stands for 'full scale'.)

4. Reference Level

Displays the value of a reference line in Cartesian formats. It is selected using the **Scale Ref** key. However, the reference line is invisible (it is indicated by a small triangle adjacent to the graticule at the left). The reference levels of the complex plane format are not displayed.

When **TOP VALUE** and **BOTTOM VALUE** are used for scaling traces, these values are displayed in the area of "3. Scale/Div" and "4. Reference Level" with T&B. (T&B stands for 'top and bottom'.)

5. Marker Data Readout

Displays the values of the marker in units appropriate to the current measurement (see Chapter 7). The status of the marker is also displayed under the marker values. The following status notations are used:

Cpl	Marker couple is tuned on. (When single channel is displayed, this notation is not displayed even if the marker couple is on.)
Peak	PEAK search tracking is turned on.
Max	MAX search tracking is turned on.
Min	MIN search tracking is turned on.
Targ	TARGET search tracking is turned on.

6. Level Monitor, Marker Statistics and Width Value

Displays the level monitor value, the statistical marker values determined by using the menus accessed with the **Utility** key, and the width value determined by using the menus accessed with the **Search** key. See Chapter 7.

7. Softkey Labels

Displays the menu labels that define the function of the softkeys immediately to the right of the label.

8. Pass/Fail

Indicates the values used for limit testing when using limit lines. See "Limit Line Concept" in Chapter 8.

9. DC BIAS ON notation

When dc bias is turned on, DC BIAS ON is displayed in this area. This notation is not display when the screen displays user trace.

10. DC Bias Level

Displays the dc bias level and limit value of the dc bias when it is turned on. The dc bias limit level is displayed in brackets.

11. Instrument BASIC Status (Run Light)

Shows current status of Instrument BASIC

□(blank)	Program stopped; can execute commands; CONTINUE not allowed.
-	Program paused; can execute commands; CONTINUE is allowed.
?	BASIC program waiting for input from keyboard; cannot execute commands.
*	This indication has two possible meanings: <ul style="list-style-type: none">■ Program running; CANNOT execute BASIC commands. CONTINUE not allowed.■ System executing command entered from keyboard; CANNOT enter commands.

12. Stimulus Span/Stop Value

Displays the stop frequency of the sweep range in frequency domain measurements or the upper limit of a OSC level or dc bias sweep. When the stimulus is in center/span mode, the span is shown in this space. The stimulus values can be blanked (see “Display” in Chapter 5).

13. CW Frequency

Displays the measurement frequency when the OSC level or dc bias sweep is selected. When the frequency sweep is selected, this area is blank.

14. Stimulus Center/Start Value

Displays either the start frequency of the sweep range for frequency domain measurements or the lower power value in OSC level or dc bias sweep. When the stimulus is in center/span mode, the center stimulus value is shown in this space.

15. OSC Level

Displays the OSC level of the test signal output when the stimulus is frequency or dc bias. When the OSC level is selected as stimulus, this area is blank.

16. Status Notations

Displays the current status of various functions for the active channel. The following notations are used:

*	Stimulus parameters changed: measured data in doubt until a complete fresh sweep has been taken.
V↓	DC bias output is clamped to the current limit.
I↓	DC bias output is clamped to the voltage limit.
COR	Error correction in fixed cal points is on.
CO+	Error correction with low-loss capacitor in fixed cal points is on.
Cor	Error correction in user cal points is on.
C+	Error correction with low-loss capacitor in user cal points is on.
C?	Stimulus parameters have changed and interpolated error correction in user cal points is on.
C+?	Stimulus parameters have changed and interpolated error correction with low-loss capacitor in user cal points is on.
C!	Error correction in user cal points is on but questionable. Caused by extrapolation.
C+!	Error correction with low-loss capacitor in user cal points is on but questionable. Caused by extrapolation.
CMP	Fixture compensation in fixed compensation points is on.
Cmp	Fixture compensation in user compensation points is on.
Cm?	Stimulus parameters have changed and interpolated fixture compensation is on.
Cm!	Fixture compensation in user compensation points is on but questionable. Caused by extrapolation.
Del	Port extension has been added or subtracted. (Del stands for “delay”.)
Avg	Sweep-by-sweep averaging is on. The averaging count is shown below.
D-M	Data math (Data Trace - Memory Trace) is on.
D+M	Data math (Data Trace + Memory Trace) is on.
D/M	Data math (Data Trace/Memory trace) is on.
D*M	Data math (Data Trace×Memory trace) is on.
G*	Data math Gain is on.
-O	Data math Offset is on.
G&O	Data math Gain and Offset are on.
Hld	Hold sweep.
↑	Fast sweep indicator.
ext	Waiting for external trigger (BNC in rear panel).
man	Waiting for manual trigger.
bus	Waiting for GPIB trigger.
Svc	A service mode is turned on. If this notation is shown, the measurement data will be out of specifications. See <i>Service Manual</i> for more information. (Service manual is furnished with Option 0BW.)

17. Equivalent Circuit Parameters

Displays equivalent circuit parameters by using menu accessed with **Display** key. See “Equivalent Circuit Menu” in Chapter 5.

18. External Reference

ExtRef is displayed when an external reference signal is connected to the external reference input on the rear panel (even if phase is not locked).

19. Active Entry Area

Displays the active function and its current value.

20. Message Area

Displays prompts or error messages. See “Error Messages” for more information on error messages.

21. Title

Displays a descriptive alpha-numeric string title defined by you and entered as described in “[Display](#)” in Chapter 5.

Rear Panel Features and Connectors

Figure 2-3 shows the features and connectors on the rear panel. Requirements for the input signals to the rear panel connectors are provided in Chapter 12.

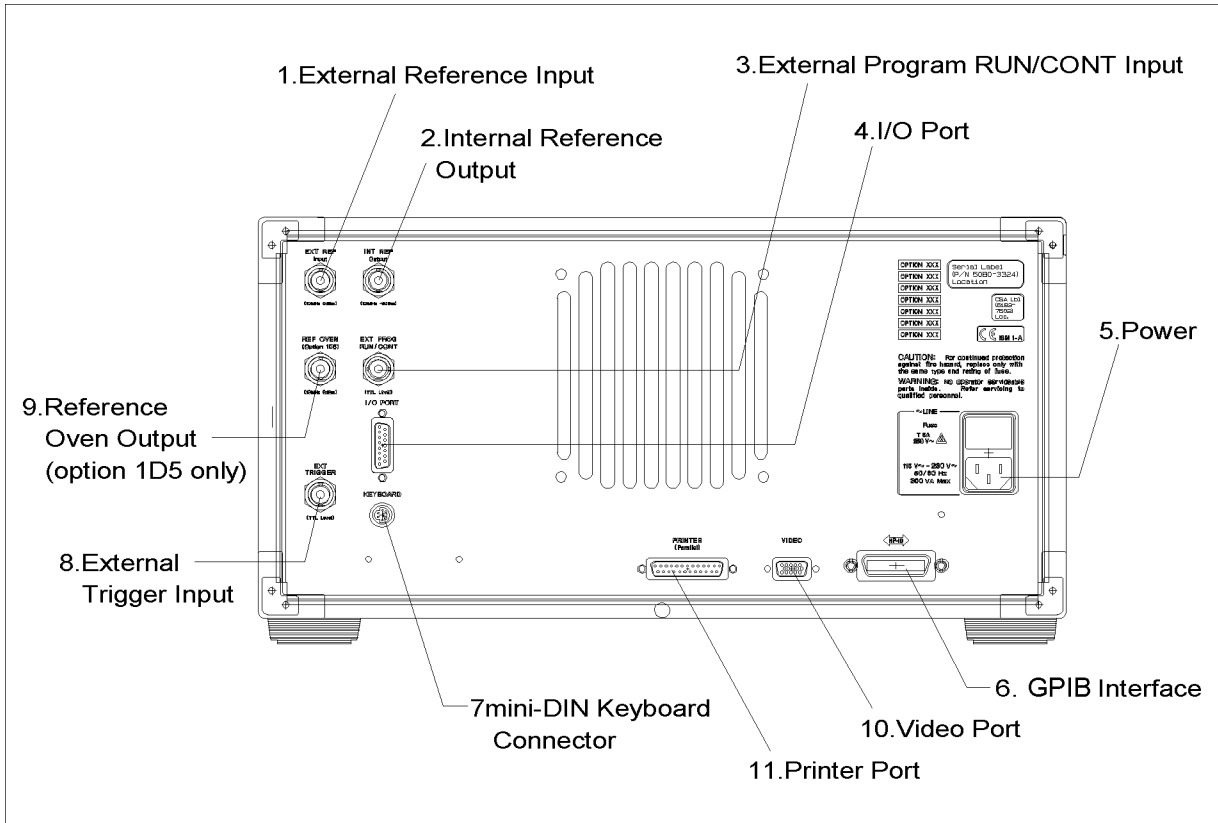

CE002003

Figure 2-3. Analyzer Rear Panel

1. External Reference Input

Connects an external frequency reference signal to the analyzer that is used to phase lock the analyzer for increased frequency accuracy.

When the analyzer is equipped with the external oven (option 1D5), this connector must be connected to REF OVEN connector.

The external frequency reference function is automatically enabled when a signal is connected to this input. When the signal is removed, the analyzer automatically switches back to its internal frequency reference.

2. Internal Reference Output

Connects to the frequency reference input of an external instrument to phase lock it to the analyzer.

3. External Program RUN/CONT Input

Externally triggers RUN or CONT of the HP Instrument BASIC program. The positive edge of a pulse more than 20 μ s wide in the LOW state triggers RUN or CONT. The signal is TTL-compatible.

4. I/O Port

Connects to external devices such as a handler on a production line. For more information on I/O port, see “I/O Port”.

5. Power

This is input for the main power cable. Insert the main-power cable plug only into a socket outlet that has a protective ground contact.

6 GPIB Interface

Connects the analyzer to an external controller and other instruments in an automated system. This connector is also used when the analyzer itself is the controller of compatible peripherals. See “GPIB” in Chapter 8.

7. mini-DIN Keyboard Connector

Connects the keyboard that is usually used with HP Instrument BASIC.

8. External Trigger Input

Triggers a measurement sweep. The positive (or negative) edge of a pulse more than 20 μ s wide in the LOW (or HIGH) state starts a measurement. The signal is TTL-compatible. To use this connector, set the trigger mode to external using softkey functions (see “Trigger” in Chapter 6).

9. Reference Oven Output (Option 1D5 Only)

Connects to the EXT REF INPUT connector when option 1D5 is installed. Option 1D5 improves the frequency accuracy and stability of the analyzer.

10. Video Port

This terminal outputs measurement results to an external color monitor. Color monitors supporting VGA (scan speed of 31.5 kHz) can be connected to this terminal.

11. Printer Port

This interface enables the output of displayed results to a printer. It complies with the Centronics parallel interface standard. See “Printer” in Chapter 10 for supported printers.

I/O Port

Figure 2-4 shows the pin assignment of I/O port on the rear panel.

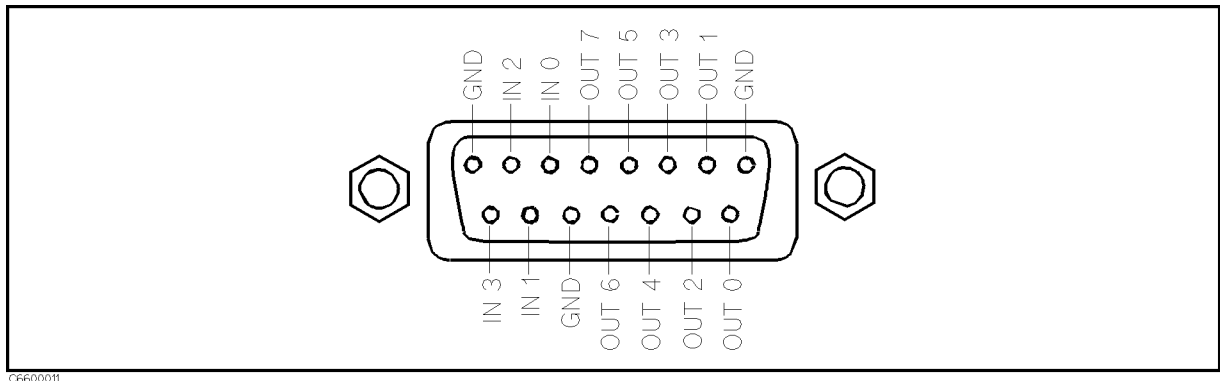

Figure 2-4. Pin Assignment of I/O Port

The signals carried through each pin are described below.

- | | |
|--------------|---|
| OUT 0 thru 7 | Output signals to external devices. Controlled by GPIB commands and HP Instrument BASIC statements and functions, as described below. Once <code>SYST:COMM:PAR:TRAN:DATA</code> is executed, the signal is latched until this command is executed again or power OFF. |
| IN 0 thru 4 | Input signals from external devices. Read by the GPIB command <code>SYST:COMM:PAR:DATA?</code> , as described below. |

■ Related GPIB Commands

There are two GPIB commands that directly control an I/O port.

- `SYST:COMM:PAR:TRAN:DATA`

This command outputs 8-bit data to the OUT 0 thru 7 lines. The OUT 0 signal is the LSB (least significant bit). The OUT 7 signal is the MSB (most significant bit).

- `SYST:COMM:PAR:DATA?`

This command inputs data from the 4-bit parallel input port to the analyzer, and outputs the data to the controller.

■ Related HP Instrument BASIC Statement and Function

HP Instrument BASIC can access an I/O port directly by using the following statement and function.

- `WRITEIO 15,0;A`

This statement outputs decimal value, *A*, as 8-bit data to the OUT 0 thru 7 lines. The OUT 0 signal is the LSB (least significant bit). The OUT 7 signal is the MSB (most significant bit).

- `READIO(15,0)`

This function inputs data from the 4-bit parallel input port to the analyzer, and returns the data to the HP Instrument BASIC program.

■ **Circuit of I/O Port**

Figure 2-5 shows the internal circuits of the I/O port.

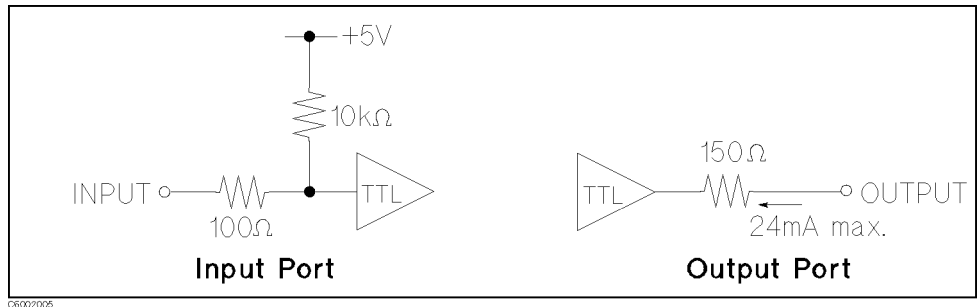
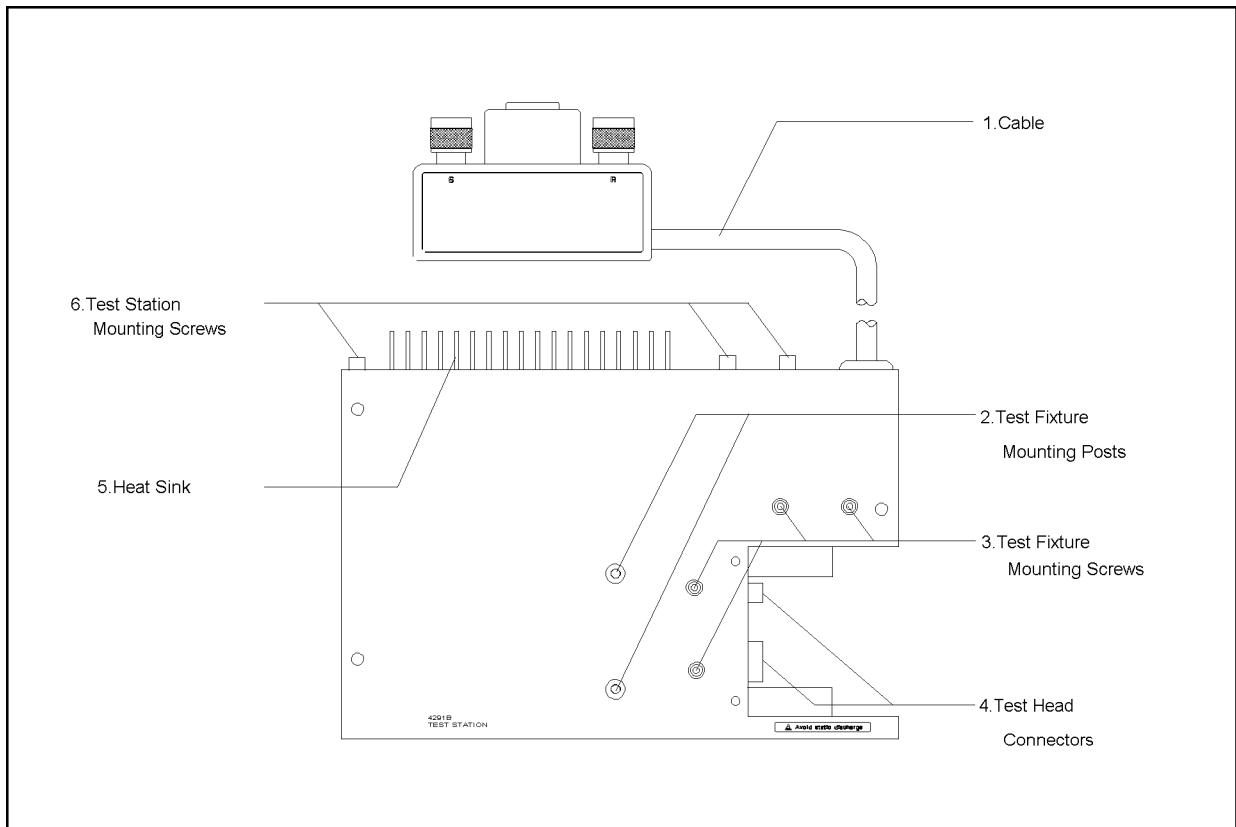

Figure 2-5. Circuit of I/O Port

■ **Connector**

- D-SUB 15 pin

Test Station



CE002006

Figure 2-6. Test Station

- 1. Cable** Connects to test station to the front panel of the main frame.
- 2. Test Fixture Mounting Posts** Locates and positions a test fixture to be used.
- 3. Test Fixture Mounting Screws** Fixes a test fixture to be used.
- 4. Test Head Connectors** Connects to a test head.

Caution



Protect the instrument from ESD damage by wearing a grounding strap that provides a high resistance path to ground. Alternatively, ground yourself to discharge any static charge built-up by touching the outer shell of any grounded instrument chassis before touching the test port connectors.

5. Heat Sink

Sinks heat of the test station. When you install the test station, you keep space around heat sink in order to radiate heat as shown in Figure 2-7.

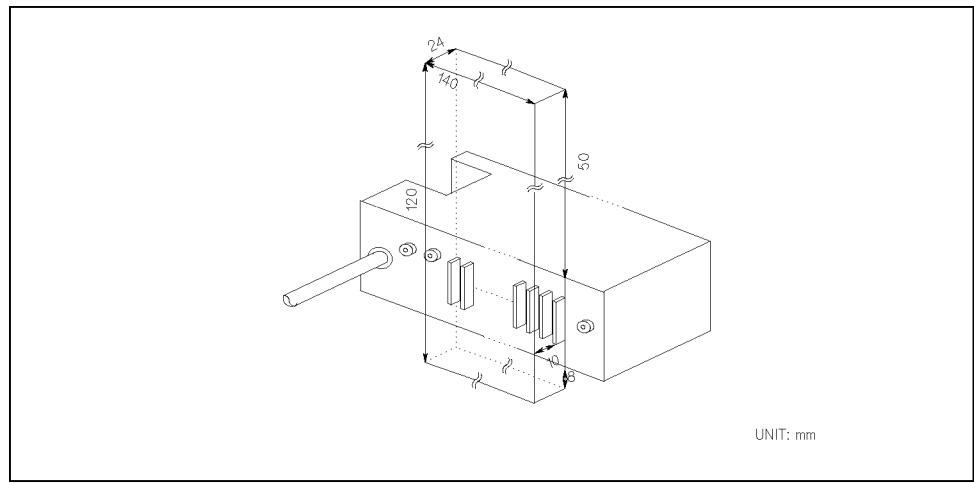

Figure 2-7. Keeping Space Around the Heat Sink

6. Test Station Mounting Screws

Fixes the test station to the peripheral, such as handler. See Figure 2-8 for the dimensions of the test station mounting screws.

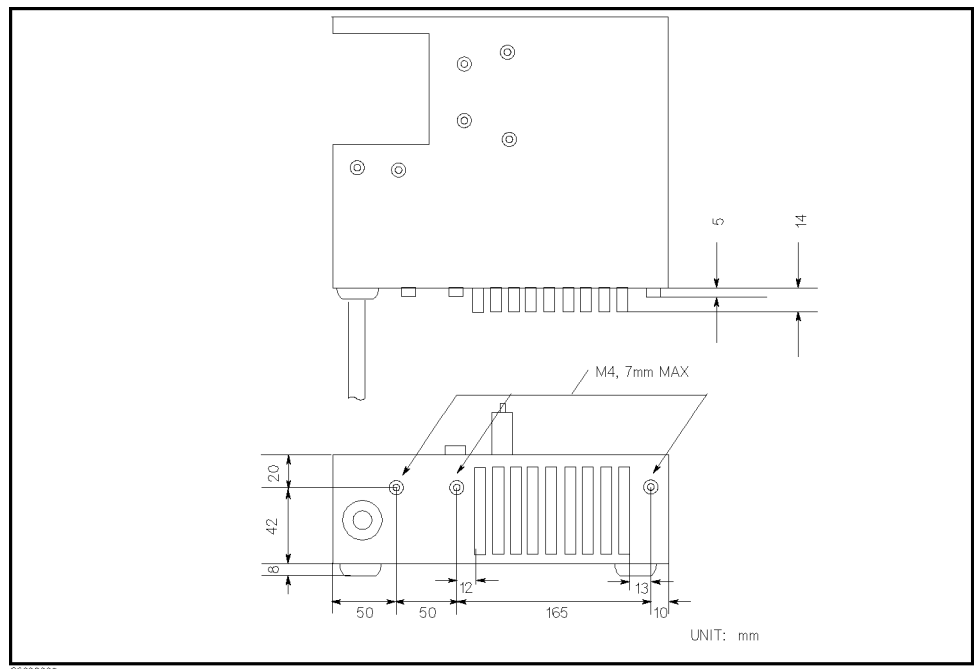
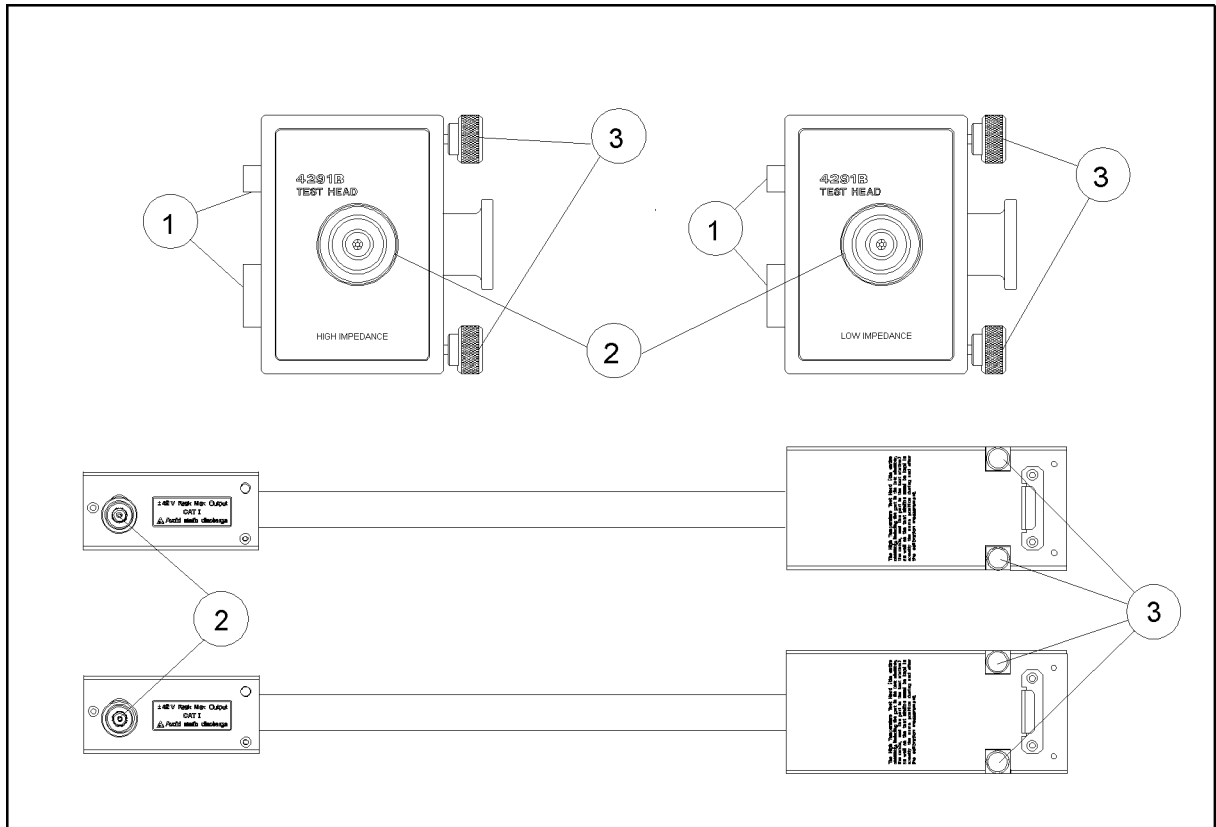

Figure 2-8. Dimensions of Test Station

Test Heads



CE002007

Figure 2-9. Test Heads

- 1. Connectors** Connects to the test station.
- 2. APC-7[®] Connector** Connects to a test fixture. These terminals comply with INSTALLATION CATEGORY I of IEC 1010-1.
- 3. Knobs** Fixes the test head to the test station.

High Impedance Measurement Test Head

This test head is designed to measure high impedance with better accuracy. As a guide, when the impedance value of a DUT is greater than about 300 Ω , use the high impedance measurement test head. This test head is furnished with 4291B. This test head is also used with the 16453A Dielectric Material Test Fixture.

The impedance measurement accuracy using this test set is shown in the Chapter 12 (bound with this manual).

Low Impedance Measurement Test Head (Option 012 only)

This test head is designed to measure low impedance with better accuracy. As a guide, when the impedance value of a DUT is less than about $5\ \Omega$, use the low impedance measurement test head. This test head is furnished with Option 012. This test head is also used with the 16454A Magnetic Material Test Fixture.

The impedance measurement accuracy using this test set is shown in the Chapter 12 (bound with this manual).

When impedance of a DUT is almost in the range from $5\ \Omega$ to $300\ \Omega$, either or both test heads can be used.

High Temperature High Impedance Test Head (Option 013 only)

This test head is designed to measure high impedance components or materials in wide temperature range. The analyzer can measure components or materials in temperature range from -55°C through $+200^{\circ}\text{C}$, when this test head is used with the 16194A High temperature component fixture or the 16453A Dielectric Material Test Fixture. This test head is furnished with Option 013.

The dimensions of this test head and the impedance measurement accuracy using this test set is shown in the Chapter 12 (bound with this manual).

High Temperature Low Impedance Test Head (Option 014 only)

This test head is designed to measure low impedance component or material in high temperature condition. The analyzer can measure components or materials in temperature range from -55°C through $+200^{\circ}\text{C}$, when this test head is used with the 16194A High temperature component fixture or the 16454A Magnetic Material Test Fixture. This test head is furnished with Option 014.

The dimensions of this test head and the impedance measurement accuracy using this test set is shown in the Chapter 12 (bound with this manual).

Handling and Storage APC-7® Connectors

- Keep connectors clean.
- Do not touch the mating plane surfaces.
- Do not set connectors contact-end down.
- Before storing, extend the sleeve.
- Use end caps over the mating plane surfaces.
- Never store connectors loose in a box or a drawer.

Microwave connectors must be handled carefully, inspected before use, and when not in use stored in a way that gives them maximum protection.

Avoid touching the connector mating plane surfaces and avoid setting the connector's contact-end down on any hard surface. Natural skin oils and microscopic particles of dirt are easily transferred to the connector interface and are very difficult to remove. Damage to the plating and to the mating plane surface occurs readily when the interface comes in contact with any hard surface.

Never store connectors with the contact end exposed. End caps are provided with all Agilent Technologies connectors, and these should be retained after unpacking and placed over the ends of the connectors whenever they are not in use.

Above all, never store any devices loose in a box or in a desk or a bench drawer. Careless handling of this kind is the most common cause of connector damage during storage.

Calibration devices and test fixtures should be stored in a foam-lined storage case, and protective end caps should always be placed over the ends of all connectors.

Cables should be stored in the same shape as they have when they are used - they should not be straightened - and end caps should be placed over both connectors.

The following figure summarizes these Agilent Technologies recommendations on handling and storing devices that have microwave connectors.

Handle and Store Connectors Carefully

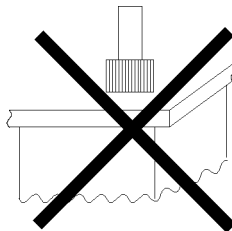

Never Place Connectors Contact-End Down

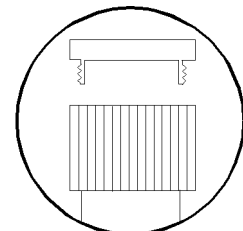

Use End Caps

- Extend threads fully when end caps are not used
- Use foam-lined storage cases if available
- Never store devices loose in a box or in a desk or bench drawer

Active Channel Block

The analyzer has two active channels (Figure 3-1) that provide independent display of data. Two different sets of data can be measured simultaneously (for example, one measurement with two different frequency spans). The data can be displayed separately or simultaneously.

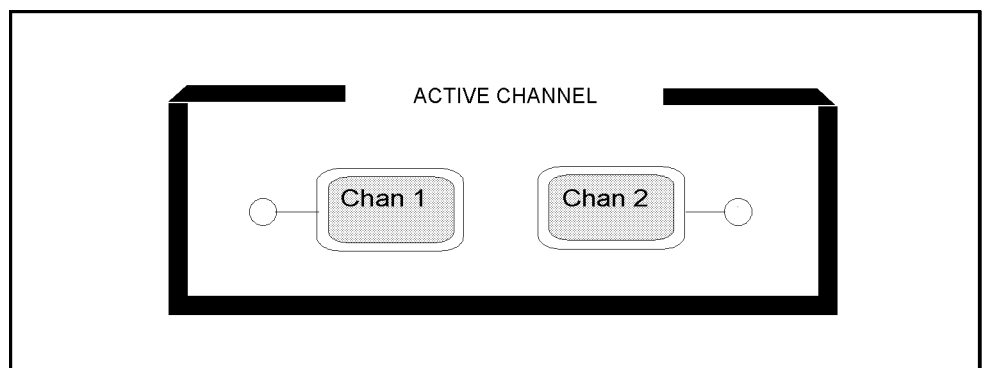

CE003001

Figure 3-1. Active Channel Keys

Chan 1 and **Chan 2**

The **Chan 1** and **Chan 2** keys select which channel is the *active channel*.

Active Channel

This is the channel currently controlled by the front panel keys. The active channel trace and data annotations are displayed on the display. All the channel specific functions that are selected apply to the active channel. The current active channel is indicated by an amber LED adjacent to the corresponding channel key.

The analyzer has dual trace capability, so that both the active and inactive channel traces can be displayed, either overlaid or on separate graticules (split display). The dual channel and split display features are available in the display menus.

Coupling Channels

Stimulus Coupling

The stimulus values can be coupled or uncoupled between the two channels (independent of the dual channel and split display functions). See “Sweep Menu” in Chapter 6 for a listing of the stimulus value that are coupled in the channel couple mode.

Marker Coupling

Another coupling capability is coupled markers. The measurement markers can have the same stimulus values for the two channels or they can be uncoupled for independent control in each channel. See Chapter 7 for more information about markers.

Entry Block

The ENTRY block (Figure 4-1) contains the numeric and unit's keypad, the knob, and the step keys. These controls are used in combination with other front panel keys and softkeys to modify the active entry, to enter or change numeric data, and to change the value of the marker. In most cases, the keypad, knob, and step keys can be used interchangeably.

Before a function can be modified, it must be made the active function by pressing a front panel key or softkey. It can then be modified directly with the knob, the step keys, or the digits' keys and a terminator.

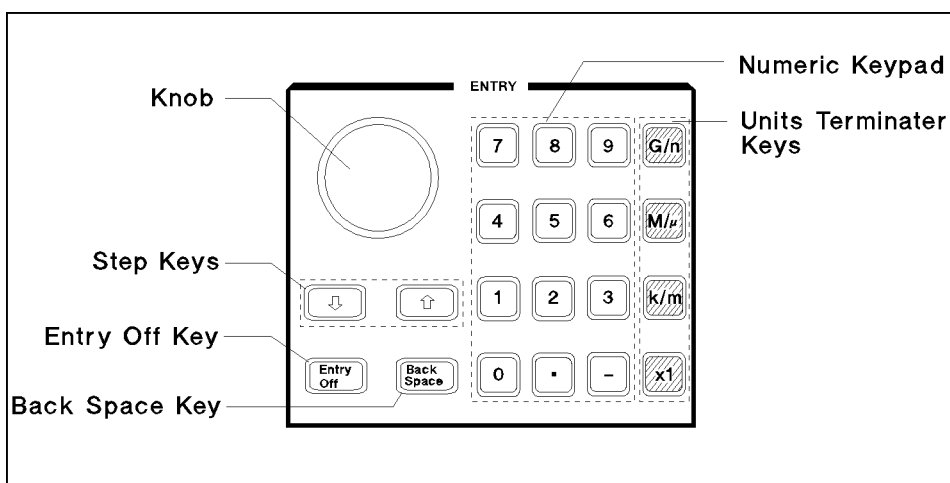





Figure 4-1. Entry Block

Numeric Keypad

The numeric keypad selects digits, decimal point, and minus sign for numerical entries. A unit's terminator is required to complete the entry.

Terminator Keys



The unit's terminator keys are the four keys in the right-hand column of the keypad. These specify units of numerical entries from the keypad and also terminate the entries. A numerical entry is incomplete until a terminator is entered. When a terminator is required, the data entry arrow "←" points at the last entered digit in the active entry area. When the unit's terminator key is pressed, the arrow is replaced by the units selected. The units are abbreviated on the terminator keys as follows:

	Giga/nano ($10^9 / 10^{-9}$)
	Mega/micro ($10^6 / 10^{-6}$)
	kilo/milli ($10^3 / 10^{-3}$)
	basic units: dB, dBm, degrees, seconds, Hz, V, A, F, H, Ω, or S. (may be used to terminate unitless entries such as averaging factor).

Knob

The knob adjusts the current values continuously for functions such as scale, reference level, and others. If a marker is on, and no other function is active, the knob can adjust the marker position. Values changed by the knob are effective immediately and require no terminator.

and

The  and  keys step the current value of the active function up or down. The steps are predetermined and cannot be altered. No unit's terminator is required with these two keys.

Entry Off

Clears and turns off the active entry area and any displayed prompts, error messages, or warnings. Use **Entry Off** to clear the display before plotting. This key also prevents active values from being changed by accidentally moving the knob. The next function selected turns the active entry area back on.

Back Space

Deletes the last entry (or the last digit entered from the numeric keypad).

Measurement Block

The measurement block keys and associated menus provide control of measurement parameter, display, equivalent circuit analysis, averaging, calibration, and fixture compensation. The following list shows the functions controlled by each key in the measurement block.

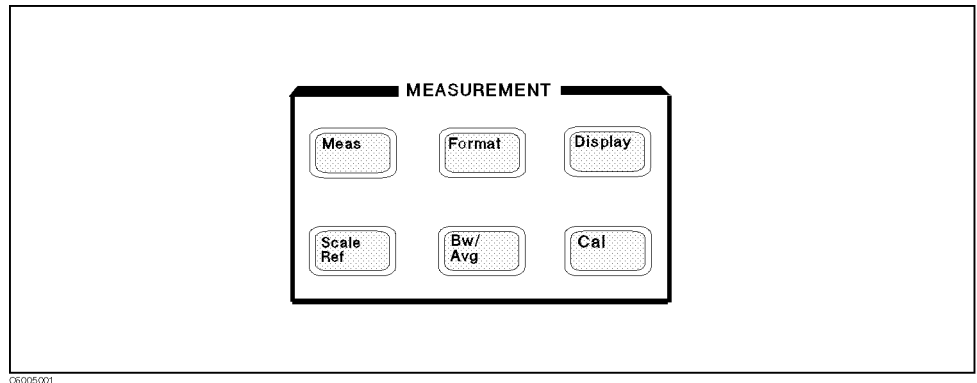
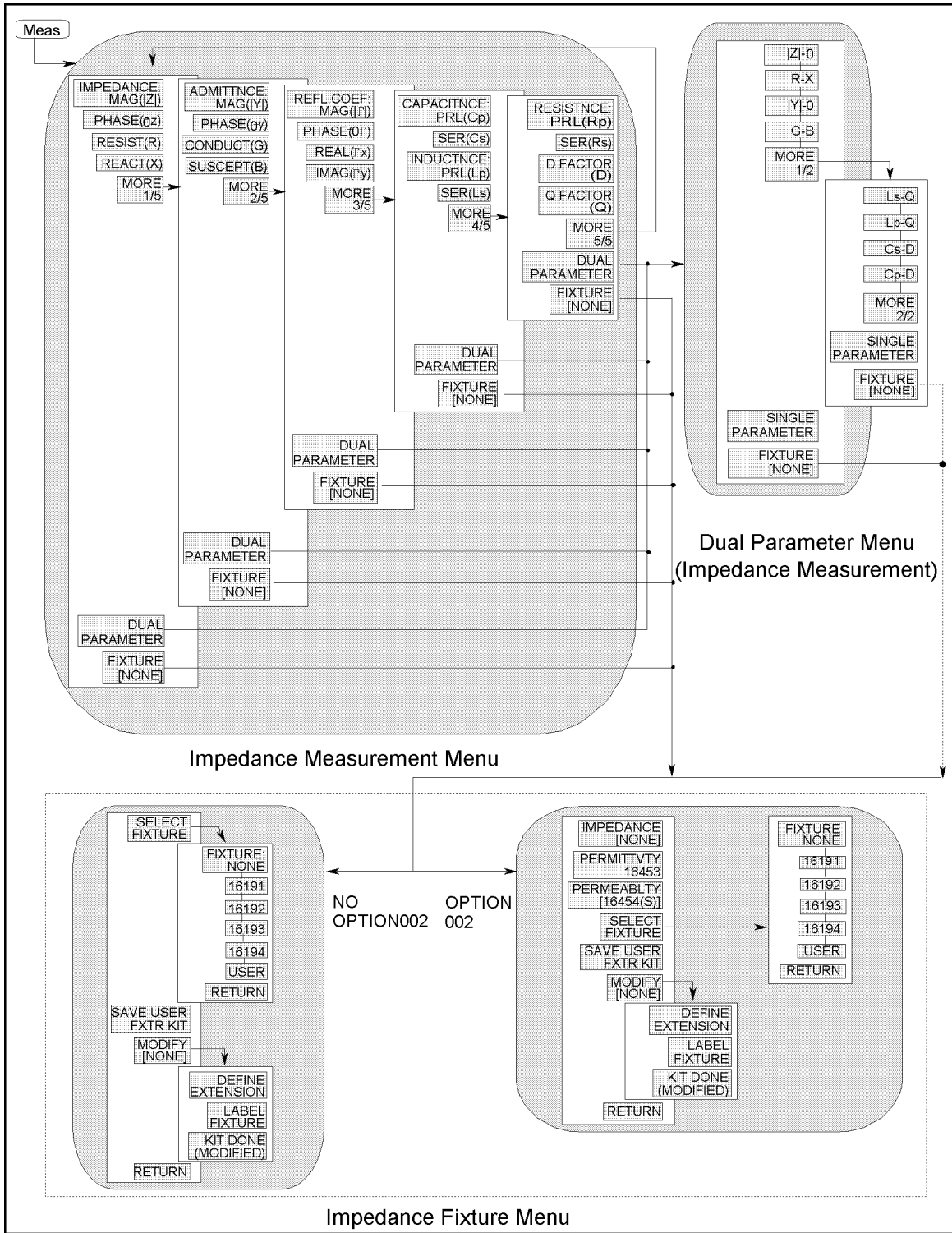

Figure 5-1. Measurement Block

- Meas**
 - Selecting parameter to be measured
 - Selecting test fixture (impedance, permittivity ϵ , and permeability μ fixtures)
- Format**
 - Selecting display format such as rectangular, Smith chart, admittance chart, polar chart, and complex plane.
- Display**
 - Selecting display trace (data and memory)
 - Storing data trace to memory trace
 - Selecting display mode
 - Dual/Single channel
 - Split/Override
 - Allocating screen between analyzer and HP Instrument BASIC.
 - Performing trace math
 - Displaying titles and text
 - Erase frequency display
 - Adjusting display color and intensity
 - Calculating equivalent circuit parameters and simulating equivalent circuit
 - Displaying user traces
- Scale Ref**
 - Scaling trace
- Bw/Avg**
 - Controlling averaging function
- Cal**
 - Performing calibration and fixture compensation measurement
 - Defining standard kits for calibration and fixture compensation

Functions accessed from this block	You can access from ...	See the following section in this chapter:
Admittance chart format	Format	<i>Format menu</i>
Averaging	Bw/Avg	<i>Averaging menu</i>
BASIC screen	Display	<i>Display menu</i>
Cal kit definition	Cal	<i>Calibration menu</i>
Calibration	Cal	<i>Calibration menu</i>
Complex plan format	Format	<i>Format menu</i>
Display adjust (Color adjust)	Display	<i>Display menu</i>
Dual parameter setting	Meas	<i>Measurement menu</i>
Equivalent circuit	Display	<i>Display menu</i>
Fixture compensation	Cal	<i>Calibration menu</i>
Frequency Blank	Display	<i>Display menu</i>
Linear rectangular format	Format	<i>Format menu</i>
Log rectangle format	Format	<i>Format menu</i>
Material measurement	Meas	<i>Fixture menu</i>
Measurement parameter selection	Meas	<i>Impedance Measurement Menu</i>
Memory trace	Display	<i>Display menu</i>
OPEN, SHORT, or LOAD definition for fixture compensation	Cal	<i>Calibration menu</i>
Polar chart format	Format	<i>Format menu</i>
Scaling trace	Scale/Ref	<i>Scale menu</i>
Smith chart format	Format	<i>Format menu</i>
Single parameter setting	Meas	<i>Measurement menu</i>
Split display and override	Display	<i>Display menu</i>
Test fixture selection	Meas	<i>Test Fixture Selection</i>
Trace math	Display	<i>Display menu</i>
Title and text on the screen (labeling graphics)	Display	<i>Display menu</i>

For Additional Information on ...	See ...
Preset values and Setting Range of each function setting value	Appendix B in this manual
All Softkey Trees	Appendix C in this manual
GPIB Command Reference	GPIB Command Reference in the <i>Programming Manual</i>
How to control the 4291B using an external controller or the HP Instrument BASIC capability through the GPIB.	<i>Programming Manual</i>



CE005006

Figure 5-2. Softkey Menus Accessed from the **Meas** Key for Impedance Measurement

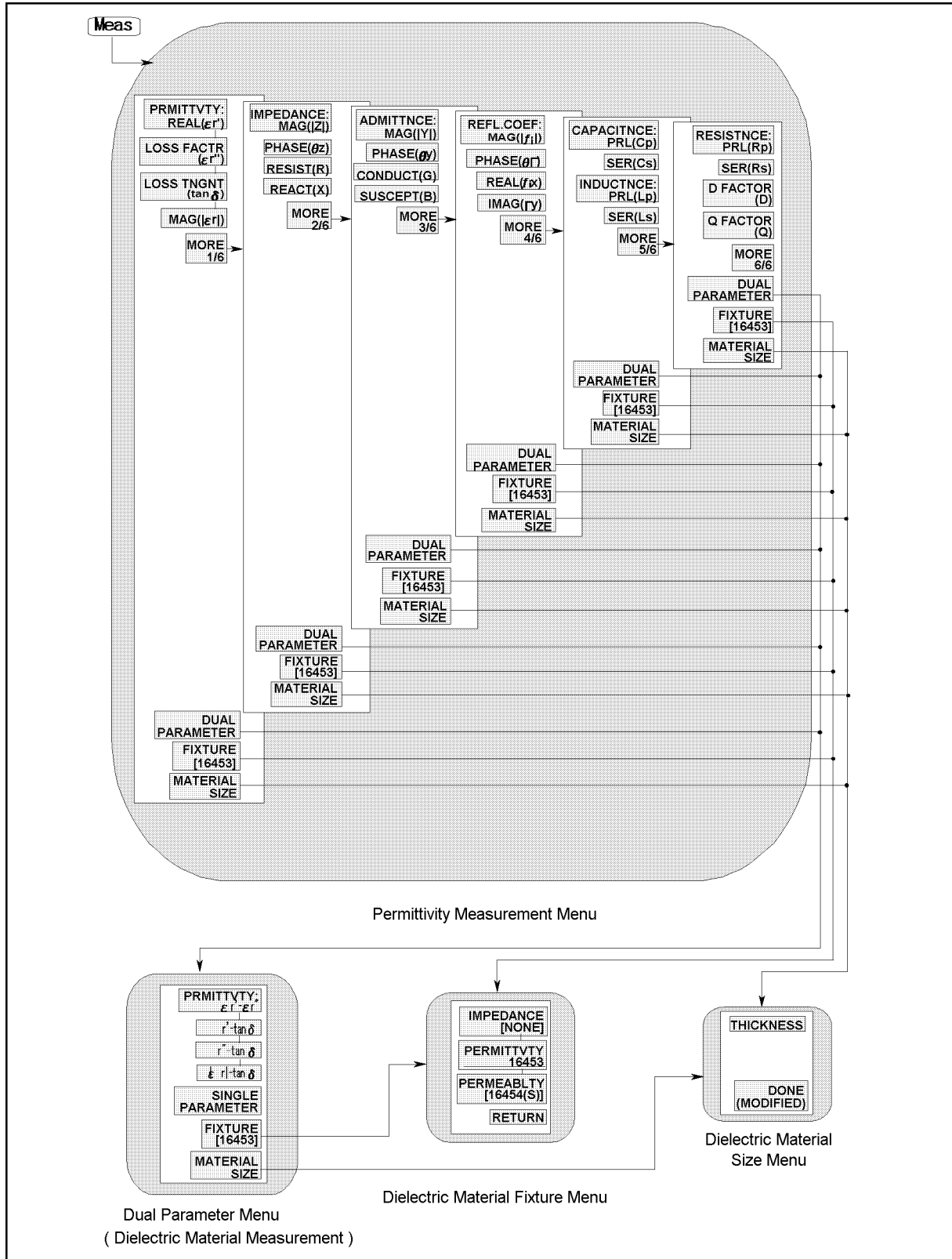

CE005060

Figure 5-3. Softkey Menus Accessed from the Meas Key for Permittivity Measurement

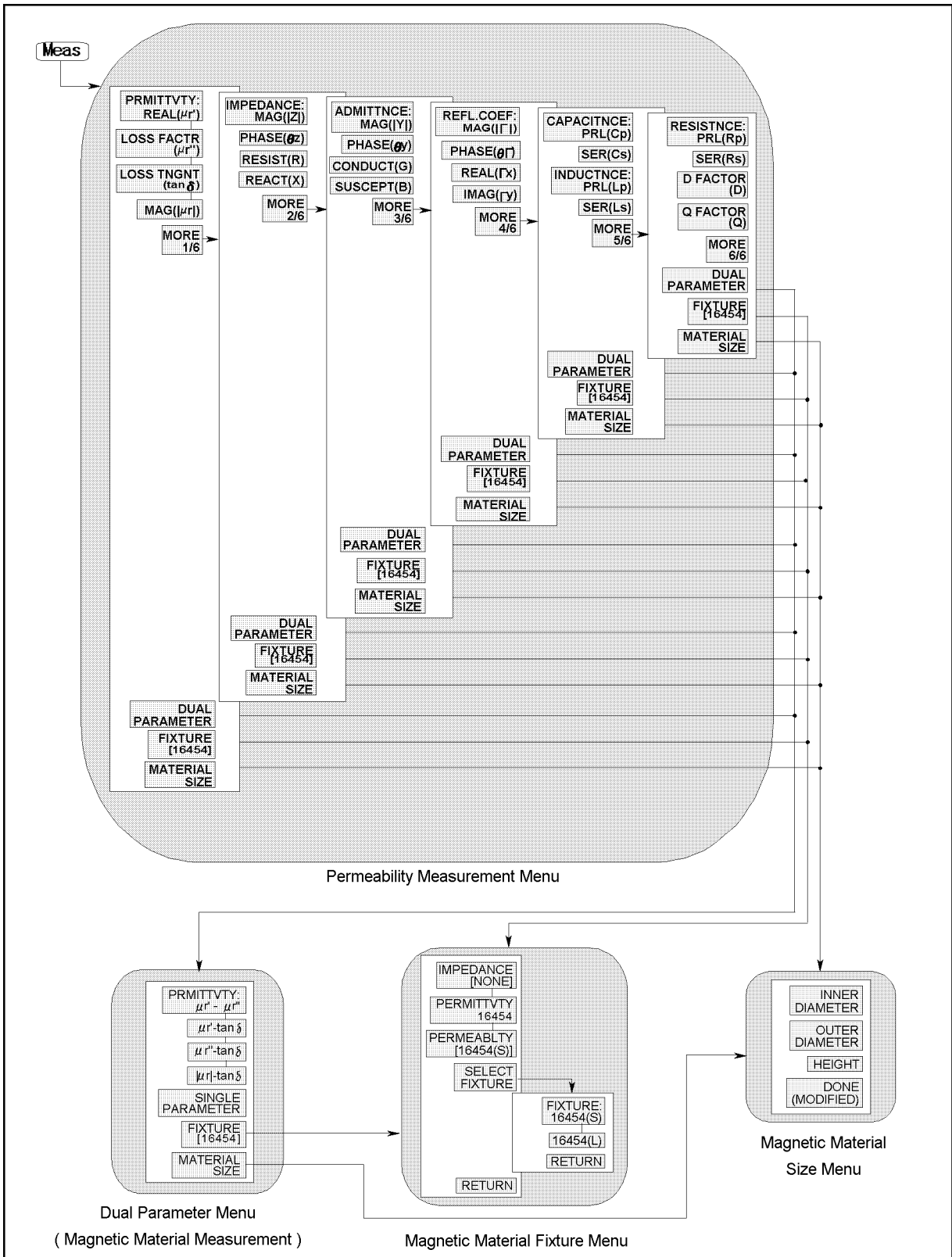

CE005061

Figure 5-4. Softkey Menus Accessed from the (Meas) Key for Permeability Measurement

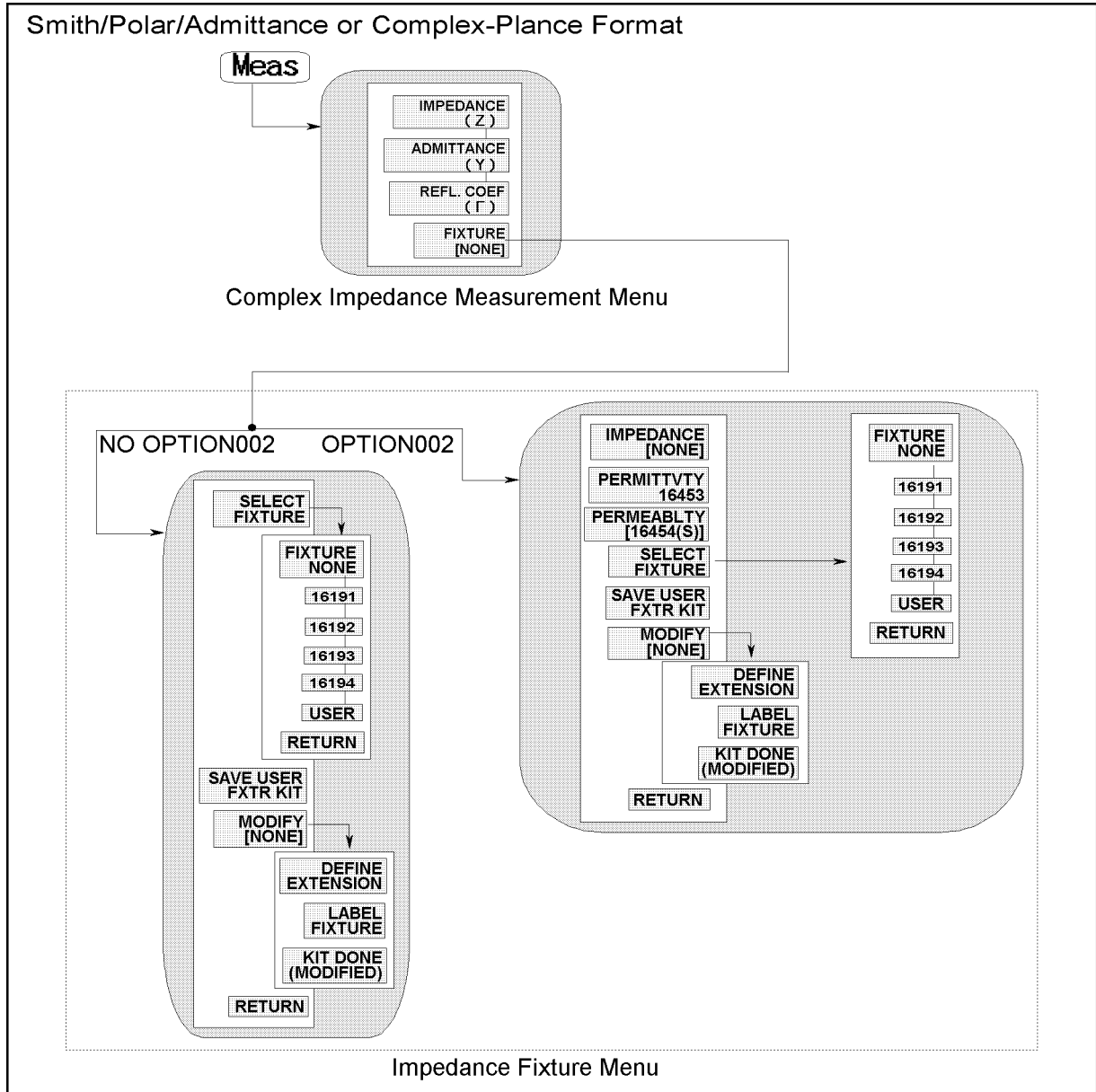
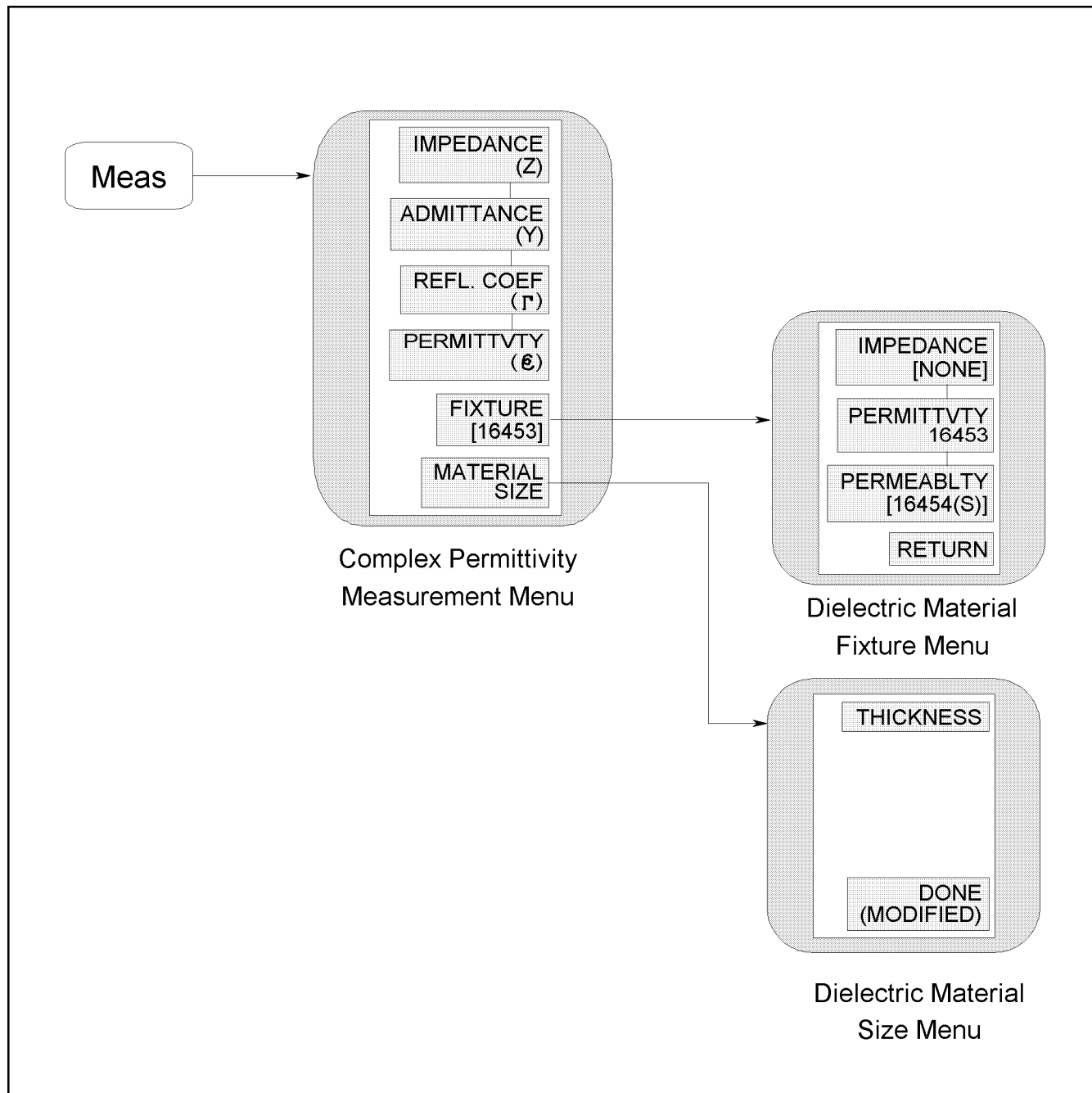
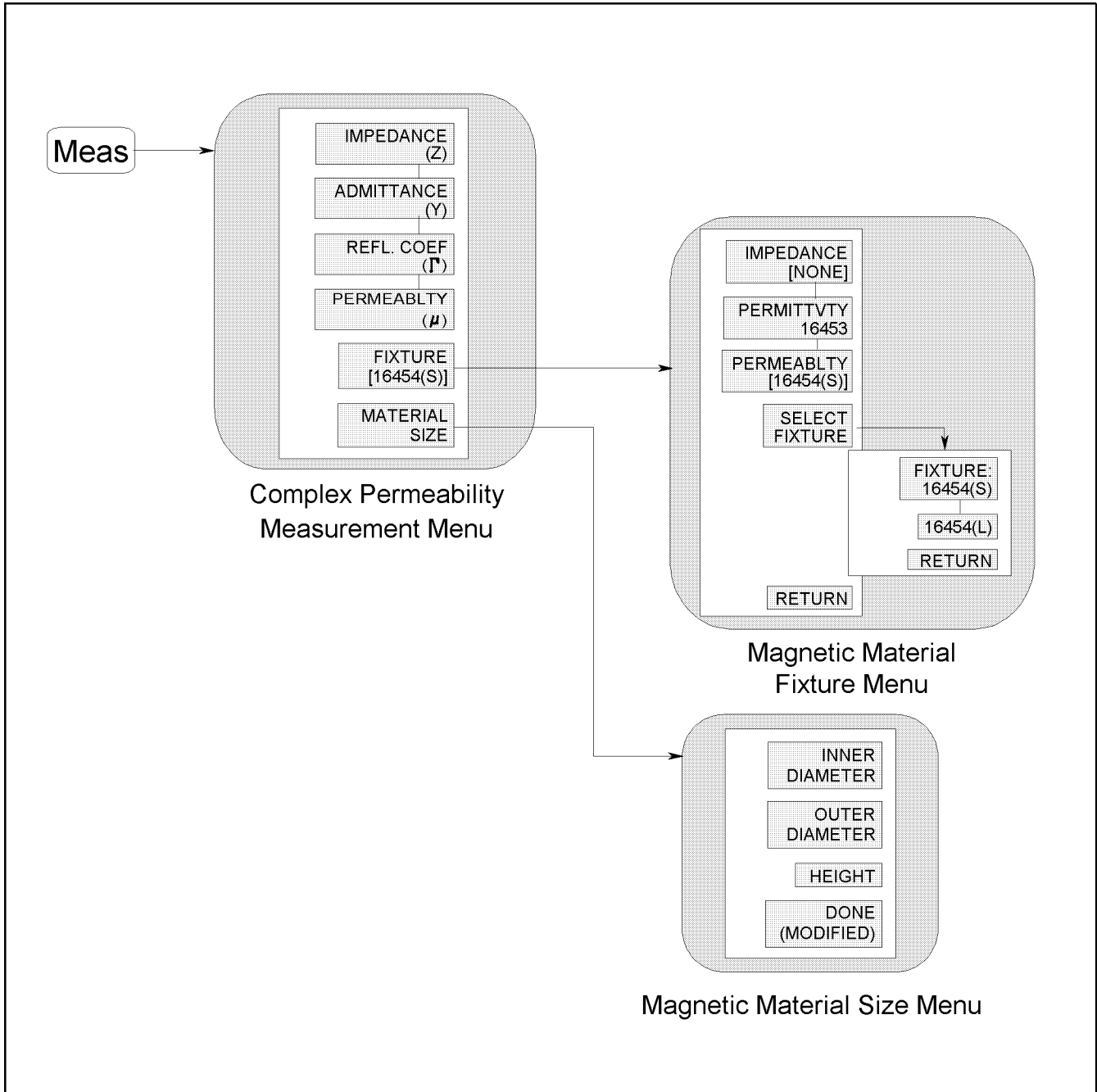

Figure 5-5.
Softkey Menus Accessed from the **Meas** Key for Impedance Measurement (when Smith/Polar/Admittance or Complex-Plane Format is selected)



CE005049

Figure 5-6.
Softkey Menus Accessed from the Meas Key for Permittivity Measurement (when Smith/Polar/Admittance or Complex-Plane Format is selected)



CE005050

Figure 5-7.
Softkey Menus Accessed from the **Meas Key for Permeability Measurement (when Smith/Polar/Admittance or Complex-Plane Format is selected)**

Impedance Measurement Menu

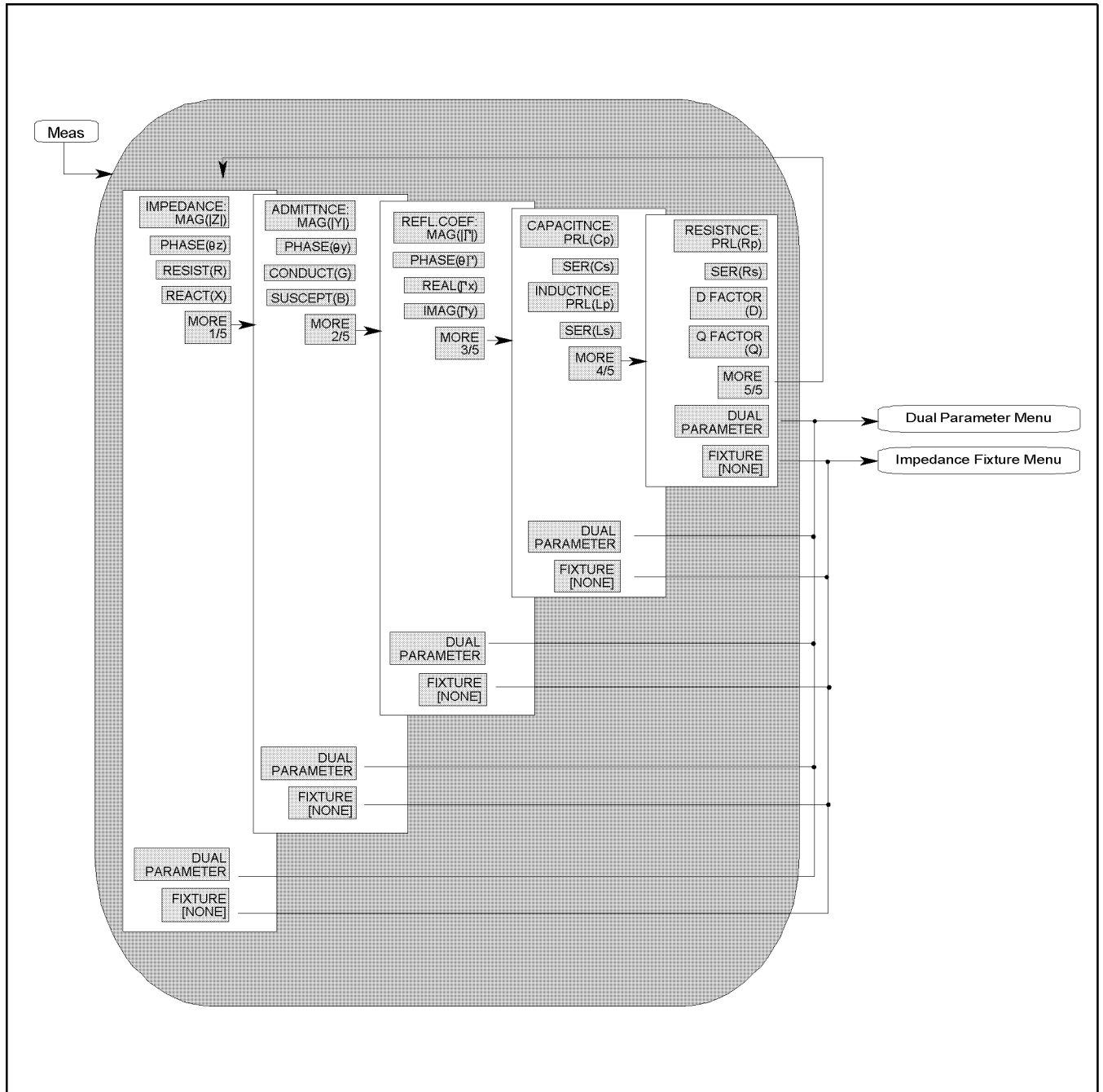

CE005007

Figure 5-8. Impedance Measurement Menu

- **IMPEDANCE: MAG(|Z|)** Measures absolute magnitude value of impedance ($|Z|$).
- **PHASE(θ_z)** Measures phase value of impedance (θ_z).
- **RESIST(R)** Measures resistance value (R).

Meas (Impedance Measurement)

- **REACT(X)** Measures reactance value (X).
- **ADMITTNC:MAG(|Y|)** Measures absolute magnitude value of admittance (|Y|).
- **PHASE(θ_y)** Measures phase value of admittance (θ_y).
- **CONDUCT(G)** Measures conductance value (G).
- **SUSCEPT(B)** Measures susceptance value (B).
 - **REFL.COEF:MAG(| Γ |)** Measures absolute magnitude value of reflection coefficient (| Γ |).
 - **PHASE(θ_Γ)** Measures phase value of reflection coefficient (θ_Γ).
 - **REAL(Γ_x)** Measures real part of reflection coefficient (Γ_x).
 - **IMAG(Γ_y)** Measures imaginary part of reflection coefficient (Γ_y).
 - **CAPCITNC:PRL(C_p)** Measures parallel capacitance (C_p), which is used for small capacitance measurement.
 - **SER(C_s)** Measures series capacitance (C_s), which is used for large capacitance measurement.
 - **INDUCTNC:PRL(L_p)** Measures parallel inductance (L_p), which is used for large inductance measurement.
 - **SER(L_s)** Measures series inductance (L_s), which is used for small inductance measurement.
 - **RESISTNC:PRL(R_p)** Measures parallel resistance (R_p), which is used for large resistance, large inductance, or small capacitance.
 - **SER(R_s)** Measures series resistance (R_s), which is used for small resistance, small inductance, or large capacitance.
 - **D FACTOR (D)** Measures dissipation factor (D).
 - **Q FACTOR (Q)** Measures quality factor (Q).
- **DUAL PARAMETER** Leads to the *Dual Parameter Menu*, which is used to select parameters to be measured for both channels with one-key stroke.
- **FIXTURE []** Leads to the *Fixture Menu*, which is used to select the test fixture used with the analyzer. The selected test fixture is displayed in brackets in the softkey label.

Complex Impedance Measurement Menu

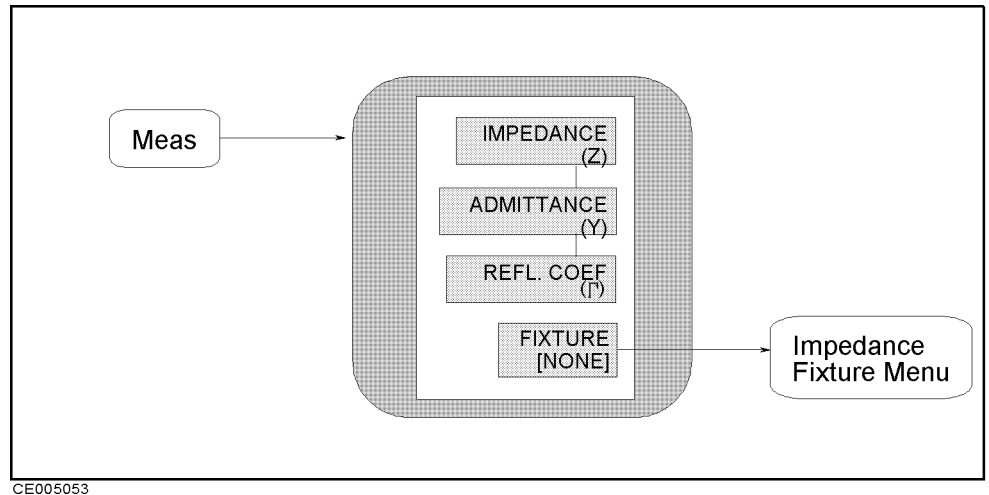

CE005053

Figure 5-9. Complex Impedance Measurement Menu

This softkey menu can be accessed at the following conditions:

- Format : the polar, Smith, admittance, or complex plane format is selected.
- Fixture : Impedance is selected.

- **IMPEDANCE (Z)** Measures complex impedance when the polar or complex plane format is selected. This softkey is not available when Smith chart or admittance chart is selected.
- **ADMITTANCE (Y)** Measures complex admittance when the polar or complex plane format is selected. This softkey is not available when Smith chart or admittance chart is selected.
- **REFL. COEF (Γ)** Measures reflection coefficient when the Smith, admittance, polar or complex plane format is selected.
- **DUAL PARAMETER** This softkey is not available for Smith, admittance, polar chart, and complex plane formats.
- **FIXTURE []** Leads to the *Fixture Menu*, which is used to select the test fixture used with the analyzer. The selected test fixture is displayed in brackets in the softkey label.
- **MATERIAL SIZE** This softkey is not available when the fixture for impedance measurement is selected.

Dual Parameter Menu

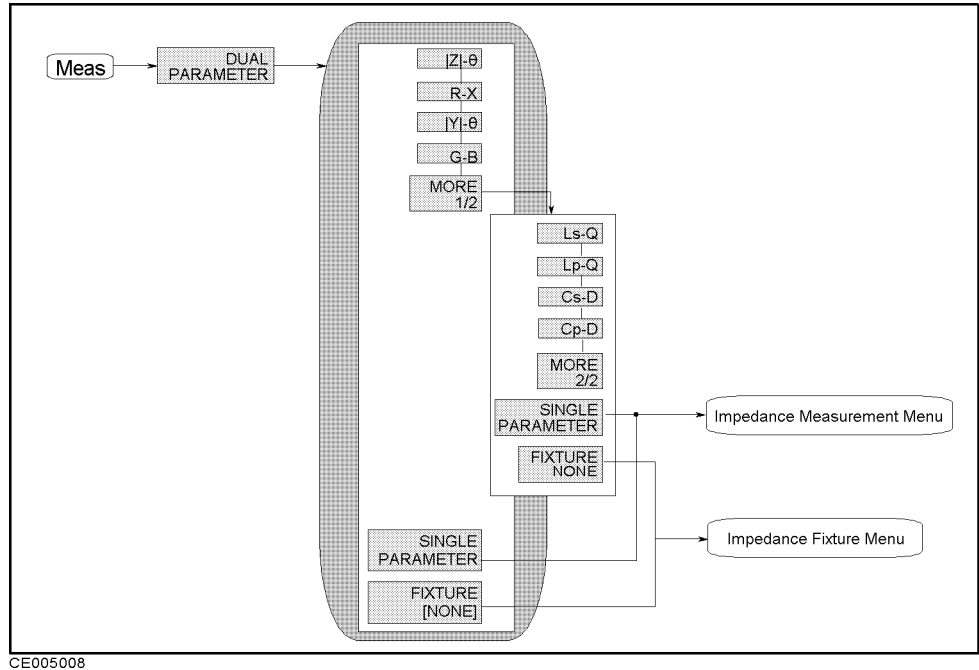

Figure 5-10. Dual Parameter Menu

- **|Z|-θ** Measures $|Z|$ on channel 1 and measures θ on channel 2.
- **R-X** Measures R on channel 1 and measures X on channel 2.
- **|Y|-θ** Measures $|Y|$ on channel 1 and measures θ on channel 2.
- **G-B** Measures G on channel 1 and measures B on channel 2.
 - **Ls-Q** Measures L_s on channel 1 and measures Q on channel 2.
 - **Lp-Q** Measures L_p on channel 1 and measures Q on channel 2.
 - **Cs-D** Measures C_s on channel 1 and measures D on channel 2.
 - **Cp-D** Measures C_p on channel 1 and measures D on channel 2.
 - **SINGLE PARAMETER** Leads to the *Impedance Measurement Menu*.
- **FIXTURE []** Leads to the *Fixture Menu*, which is used to select the test fixture used with the analyzer. The selected test fixture is displayed in brackets in the softkey label.

Measurement Parameters Summary
<p style="text-align: center;">Complex Impedance Parameters</p> <ul style="list-style-type: none"> ■ Impedance magnitude Z ■ Impedance phase θ_z ■ Resistance R ■ Reactance X
<p style="text-align: center;">Complex Admittance Parameters</p> <ul style="list-style-type: none"> ■ Admittance magnitude Y ■ Admittance phase θ_y ■ Resistance G ■ Reactance B
<p style="text-align: center;">Reflection Coefficient</p> <ul style="list-style-type: none"> ■ Reflection coefficient magnitude Γ ■ Reflection coefficient phase θ_γ ■ Real part of reflection coefficient Γ_x ■ Imaginary part of reflection coefficient Γ_y
<p style="text-align: center;">Serial Circuit parameter</p> <ul style="list-style-type: none"> ■ Serial capacitance C_s ■ Serial inductance L_s ■ Serial resistance R_s
<p style="text-align: center;">Parallel Circuit parameter</p> <ul style="list-style-type: none"> ■ Parallel capacitance C_p ■ Parallel inductance L_p ■ Parallel resistance R_p
<p style="text-align: center;">Loss</p> <ul style="list-style-type: none"> ■ Dissipation factor D ■ Quality factor Q

Note



For more information on measurement parameters and serial and parallel circuit models (such as definitions, conversion between parameters, and the selection guide for circuit models), see “Impedance parameters” in Chapter 11 and “Series and Parallel Circuit Models” in Chapter 11.

Impedance Fixture Menu (No option 002)

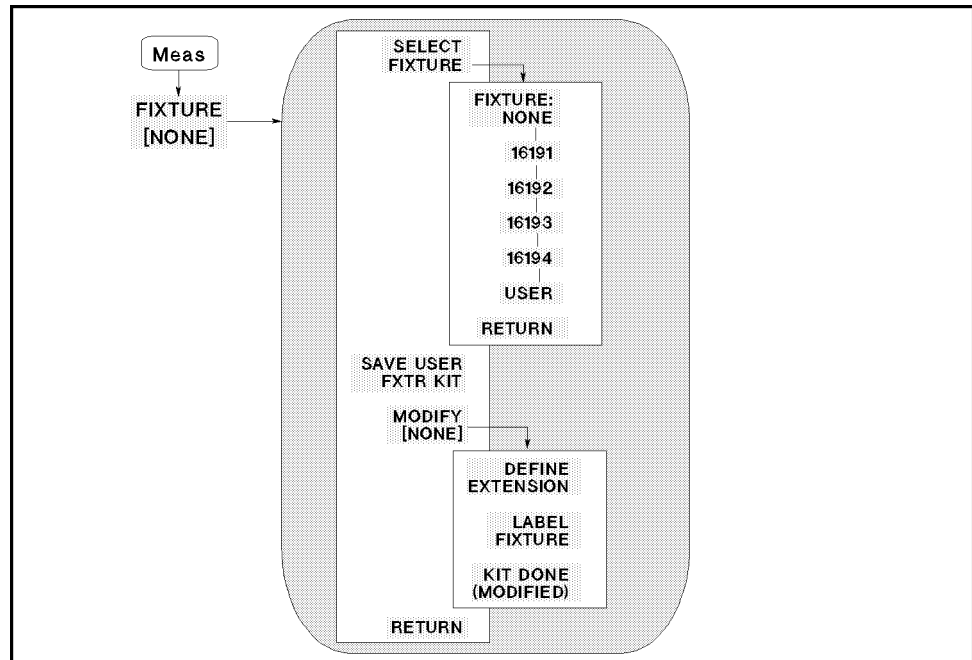

Figure 5-11. Impedance Fixture Menu (No option 002)

- **FIXTURE []** Leads to the following softkeys, which are used to select test fixture for impedance measurement.
 - **FIXTURE:NONE** Sets zero as the electrical length value. As the case you do the load compensation, select this setting.
 - **16191** Sets the electrical length that is suitable for the 16191A.
 - **16192** Sets the electrical length that is suitable for the 16192A.
 - **16193** Sets the electrical length that is suitable for the 16193A.
 - **16194** Sets the electrical length that is suitable for the 16194A.
 - **USER** Sets the electrical length that is a user defined value.
 - **SAVE USER FXTR** Saves extension value and label as a user defined fixture.
 - **MODIFY []** Leads to the following softkeys, which are used to define the electrical length and label of a selected fixture.
 - **DEFINE EXTENSION** Makes the extension value of the selected fixture the active function to define extension value.
 - **LABEL FIXTURE** Makes the fixture label name the active function to define it.
 - **KIT DONE (MODIFIED)** Completes the procedure to define the selected fixture.

Impedance Fixture Menu (Option 002 only)

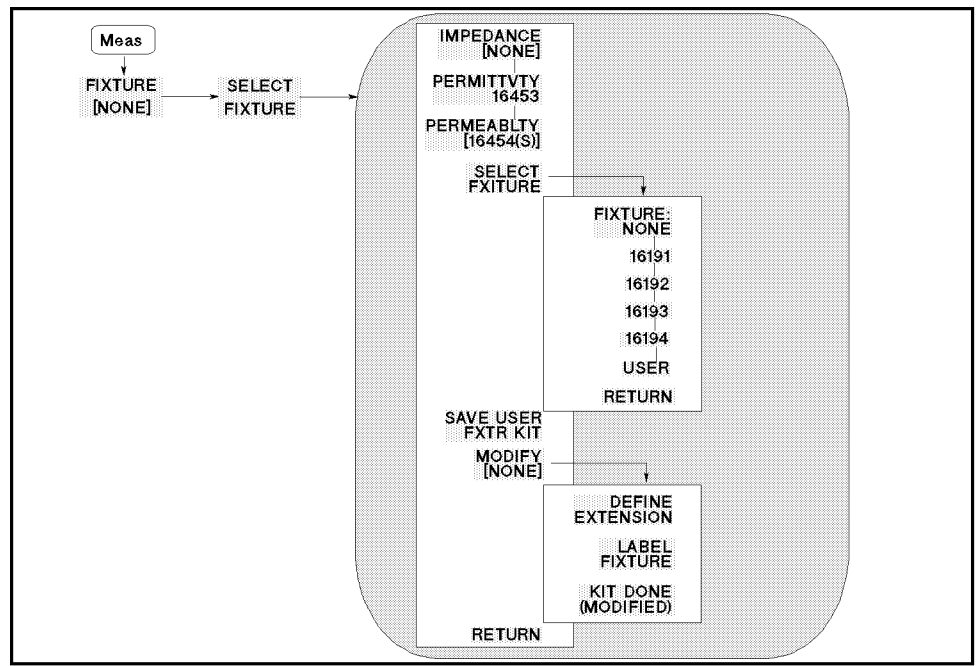

Figure 5-12. Impedance Fixture Menu (Option 002 only)

This section describes the softkeys that can be accessed when Option 002 (Material Measurement) is installed and **IMPEDANCE []** is selected in this menu.

- **IMPEDANCE []** Selects the impedance measurement. When this softkey is selected, the menu accessed from the **SELECT FIXTURE** softkey lists only the impedance fixtures. The (Meas) and (Cal) keys lead only to the menus related to the impedance measurement. When a fixture has been specified, its label is displayed in brackets in the softkey label.
- **PERMITTVTY 16453** Selects permittivity measurement. This function doesn't set the electrical length. When this softkey is selected, the (Meas) and (Cal) keys lead only to the menus related to the permittivity measurement.
- **PERMEABLY [16454()]** Selects the permeability measurement. When this softkey is selected, the menu accessed from the **SELECT FIXTURE** softkey lists only magnetic material fixtures. The (Meas) and (Cal) keys lead only to the menus related to the permeability measurement. When a fixture size has been specified, the size is displayed in parenthesis in the softkey label.
- **SELECT FIXTURE** Leads to the following softkeys, which are used to select test fixture for impedance measurement.
 - **FIXTURE:NONE** Sets zero as the electrical length value. As the case you do the load compensation, select this setting.
 - **16191** Sets the electrical length that is suitable for the 16191A.

Meas (Impedance Measurement)

- **16192** Sets the electrical length that is suitable for the 16192A.
- **16193** Sets the electrical length that is suitable for the 16193A.
- **16194** Sets the electrical length that is suitable for the 16194A.
- **USER** Sets the electrical length, which is a user defined value.
- **SAVE USER FXTR** Saves the extension value and label of a user defined fixture.
- **MODIFY []** Leads to the following softkeys, which are used to define the electrical length and label of a user's fixture.
 - **DEFINE EXTENSION** Makes the extension value of the user defined fixture the active function to define its value.
 - **LABEL FIXTURE** Makes the fixture label name the active function to define it.
 - **KIT DONE (MODIFIED)** Completes the procedure to define the user fixture and save it.

What is fixture setting?
<i>Fixture menu</i> sets the electrical length in order to cancel errors caused by an additional impedance in a distributed element of a coaxial coupling terminal between the APC-7 connector and the contact electrode of a fixture. And this setting doesn't influence calibration. For more information on fixture characteristics, see "Fixture Compensation" in Chapter 11. About the relation between fixture setting and calibration, see Figure 9-2.

User fixture definition is backed up by battery
The analyzer keeps the definition of a user fixture in the battery backup memory to ensure that the definition is retained even if the analyzer is turned off.

It is <i>not</i> necessary to set test fixture in this menu when ...
When you perform all three fixture compensation measurements (OPEN, SHORT, and LOAD), it is not necessary to specify the test fixture in this menu. Because OPEN, SHORT and LOAD compensation will remove errors caused by the phase shift, be sure to select FIXTURE: NONE before the compensation measurements are performed.
When you perform only one or two compensation measurements (OPEN and/or SHORT), you should specify the applicable fixture using this menu.

Permittivity Measurement Menu (Option 002 only)

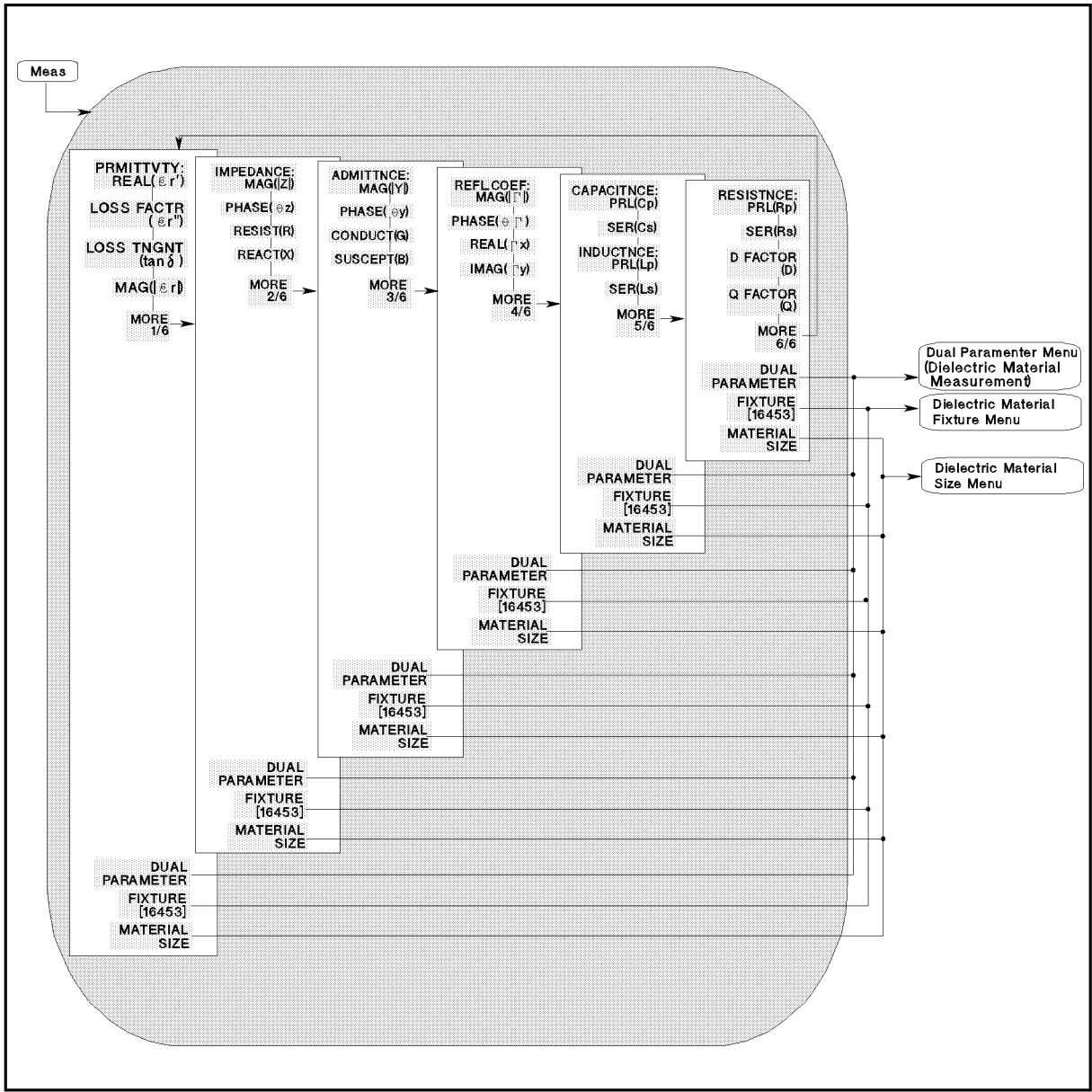

Figure 5-13. Permittivity Measurement Menu (Option 002 only)

- **PRMITTVTY: REAL(ϵ'_r)** Measures effective relative permittivity (ϵ'_r).
- **LOSS FACTR (ϵ''_r)** Measures relative dielectric loss factor (ϵ''_r).
- **LOSS TNGNT ($\tan\delta$)** Measures dielectric dissipation factor (dielectric loss tangent; $\tan\delta$).
- **MAG($|\epsilon_r|$)** Measures absolute magnitude value of permittivity ($|\epsilon_r|$).
- **MORE 1/6** leads the following softkeys, which is used to measure impedance parameter as same as the *Impedance Measurement* menu.

Meas (Dielectric Material Measurement)

- **IMPEDANCE:MAG(|Z|)** Measures absolute magnitude value of impedance ($|Z|$).
- **PHASE(θ_z)** Measures phase value of impedance (θ_z).
- **RESIST(R)** Measures resistance value (R).
- **REACT(X)** Measures reactance value (X).
 - **ADMITTANCE:MAG(|Y|)** Measures absolute magnitude value of admittance ($|Y|$).
 - **PHASE(θ_y)** Measures phase value of admittance (θ_y).
 - **CONDUCT(G)** Measures conductance value (G).
 - **SUSCEPT(B)** Measures susceptance value (B).
 - **REFL.COEF:MAG(| Γ |)** Measures absolute magnitude value of reflection coefficient ($|\Gamma|$).
 - **PHASE(θ_Γ)** Measures phase value of reflection coefficient (θ_Γ).
 - **REAL(Γ_x)** Measures real part of reflection coefficient (Γ_x).
 - **IMAG(Γ_y)** Measures imaginary part of reflection coefficient (Γ_y).
 - **CAPCITANCE:PRL(C_p)** Measures parallel capacitance (C_p), which is used for small capacitance measurement.
 - **SER(C_s)** Measures series capacitance (C_s), which is used for large capacitance measurement.
 - **INDUCTANCE:PRL(L_p)** Measures parallel inductance (L_p), which is used for large inductance measurement.
 - **SER(L_s)** Measures series inductance (L_s), which is used for small inductance measurement.
 - **RESISTANCE:PRL(R_p)** Measures parallel resistance (R_p), which is used for large resistance, large inductance, or small capacitance.
 - **SER(R_s)** Measures series resistance (R_s), which is used for small resistance, small inductance, or large capacitance.
 - **D FACTOR (D)** Measures dissipation factor (D).
 - **Q FACTOR (Q)** Measures quality factor (Q).
- **DUAL PARAMETER** Leads to the *Dual Parameter menu*, which are used to select parameters to be measured for both channels with one-key stroke.
- **FIXTURE [16453]** Leads to the *Fixture Menu*, which is used to select the test fixture used with the analyzer. 16453 is displayed in brackets in the softkey label when the permittivity measurement menu is accessed.
- **MATERIAL SIZE** Leads to the *Material Size Menu*, which is used to set the thickness of the dielectric material to be measured.

Complex Permittivity Measurement Menu (Option 002 only)

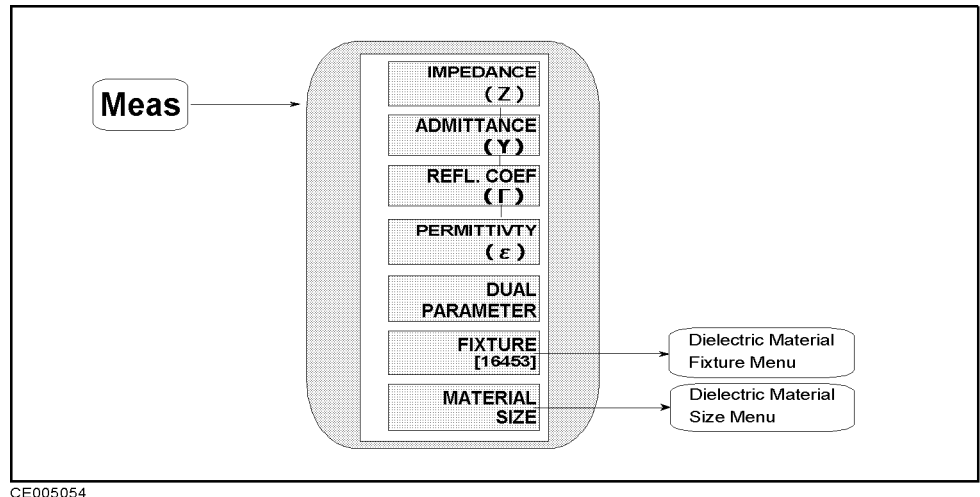

Figure 5-14. Complex Permittivity Measurement Menu (Option 002 only)

This softkey menu can be accessed at the following conditions:

- Format : the polar, Smith, admittance, or complex plane format is selected.
- Fixture : 16453A is selected.

- **IMPEDANCE (Z)** Measures complex impedance on the polar or complex plane format. This softkey is not available when Smith or admittance chart is selected.
- **ADMITTANCE (Y)** Measures complex admittance on the polar or complex plane format. This softkey is not available when Smith or admittance chart is selected.
- **REFL. COEF (Γ)** Measures complex impedance on Smith, admittance, polar or complex plane format.
- **PERMITTIVITY (ε)** Measures complex relative permittivity on the polar or complex plane format. This softkey is not available when Smith or admittance chart is selected.
- **DUAL PARAMETER** This softkey is not available for Smith, admittance, polar chart, and complex plane formats.
- **FIXTURE []** Leads to the *Fixture Menu*, which is used to select the test fixture used with the analyzer. The selected test fixture is displayed in brackets in the softkey label.
- **MATERIAL SIZE** Leads to the *Material Size Menu*, which is used to set thickness of the dielectric material to be measured.

Dual Parameter Menu (Dielectric Material Measurement)

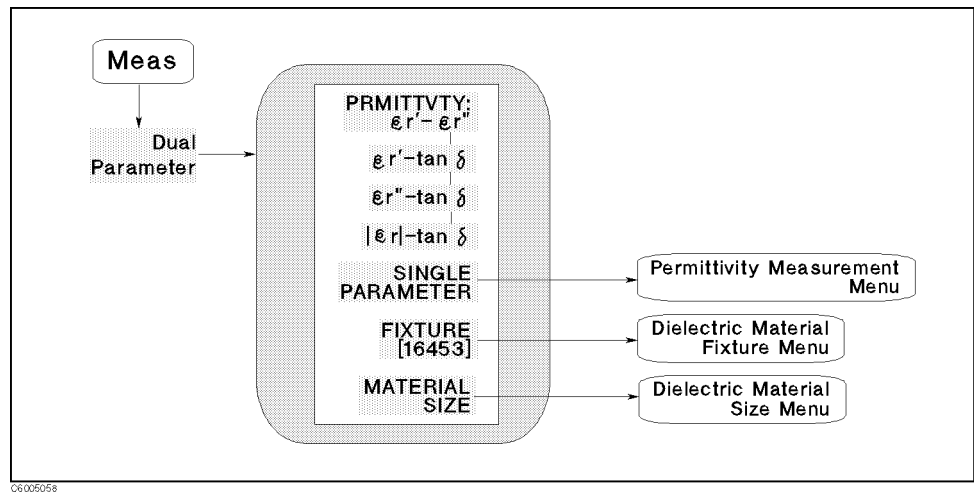
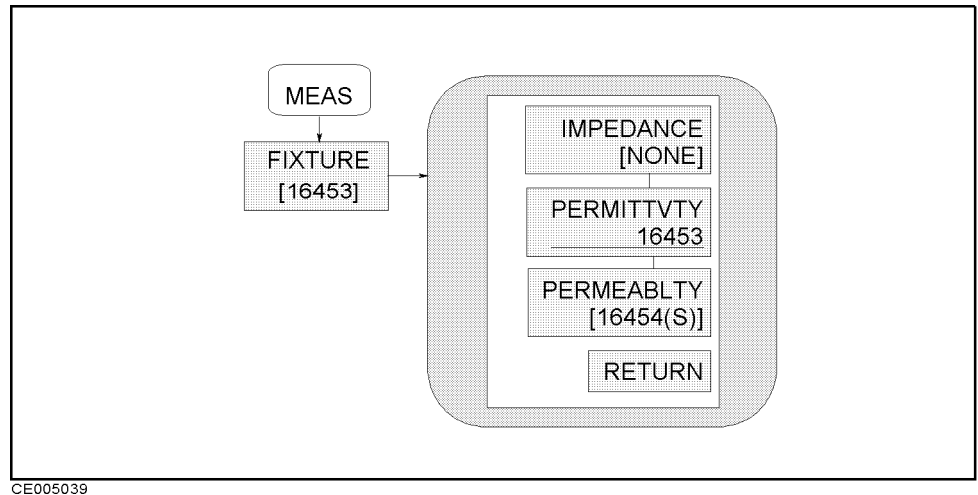

Figure 5-15.
Dual Parameter Menu (Dielectric Material Measurement)

- $\epsilon_r' - \epsilon_r''$ Measures ϵ_r' on channel 1 and measures ϵ_r'' on channel 2.
- $\epsilon_r' - \tan \delta$ Measures ϵ_r' on channel 1 and measures $\tan \delta$ on channel 2.
- $\epsilon_r'' - \tan \delta$ Measures ϵ_r'' on channel 1 and measures $\tan \delta$ on channel 2.
- $|\epsilon_r| - \tan \delta$ Measures $|\epsilon_r|$ on channel 1 and measures $\tan \delta$ on channel 2.
- SINGLE PARAMETER Leads to the *Permittivity Measurement Menu*.
- FIXTURE [16453] Leads to the *Dielectric Material Fixture Menu*, which is used to select test fixture used with the analyzer. The selected test fixture is displayed in brackets in the softkey label.
- MATERIAL SIZE Leads to the *Dielectric Material Size Menu*, which is used to set thickness of the dielectric material to be measured.

Dielectric Material Fixture Menu (Option 002 only)



CE005039

Figure 5-16. Dielectric Material Fixture Menu (Option 002 only)

This section describes the softkeys that can be accessed when Option 002 (Material Measurement) is installed and **PERMITTVTY 16453** is selected in this menu.

- **IMPEDANCE []** Selects the impedance measurement. When this softkey is selected, the menu accessed from the **SELECT FIXTURE** softkey lists only impedance fixtures. The (Meas) and (Cal) keys lead only to the menus related to the impedance measurement. When a fixture has been specified, its label is displayed in brackets in the softkey label.
- **PERMITTVTY 16453** Selects the permittivity measurement. This function doesn't set the electrical length. When this softkey is selected, the (Meas) and (Cal) keys lead only to the menus related to the permittivity measurement.
- **PERMEABLTY 16454()** Selects the permeability measurement. When this softkey is selected, the menu accessed from the **SELECT FIXTURE** softkey lists only magnetic material fixtures. The (Meas) and (Cal) keys lead only to the menus related to the permeability measurement. When a fixture size has been specified, the size is displayed in parenthesis in the softkey label.

Meas (Dielectric Material Measurement)

Dielectric Material Size Menu (Option 002 only)

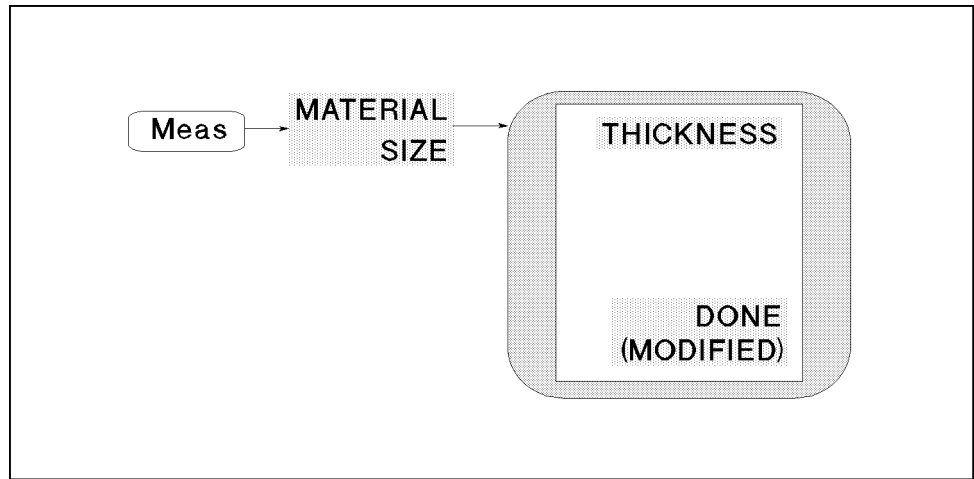

06005031

Figure 5-17. Dielectric Material Size Menu (Option 002 only)

- **THICKNESS** Sets the thickness of the dielectric material to be measured.
- **DONE (MODIFIED)** Completes the procedure to define material size.

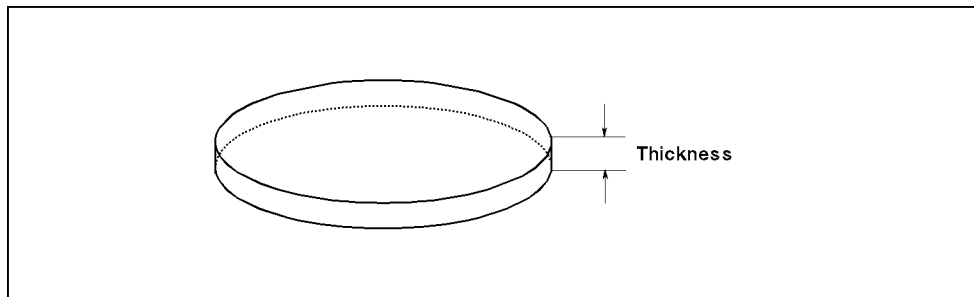

0601015

Figure 5-18. Dielectric Material Size

Permeability Measurement Menu (Option 002 only)

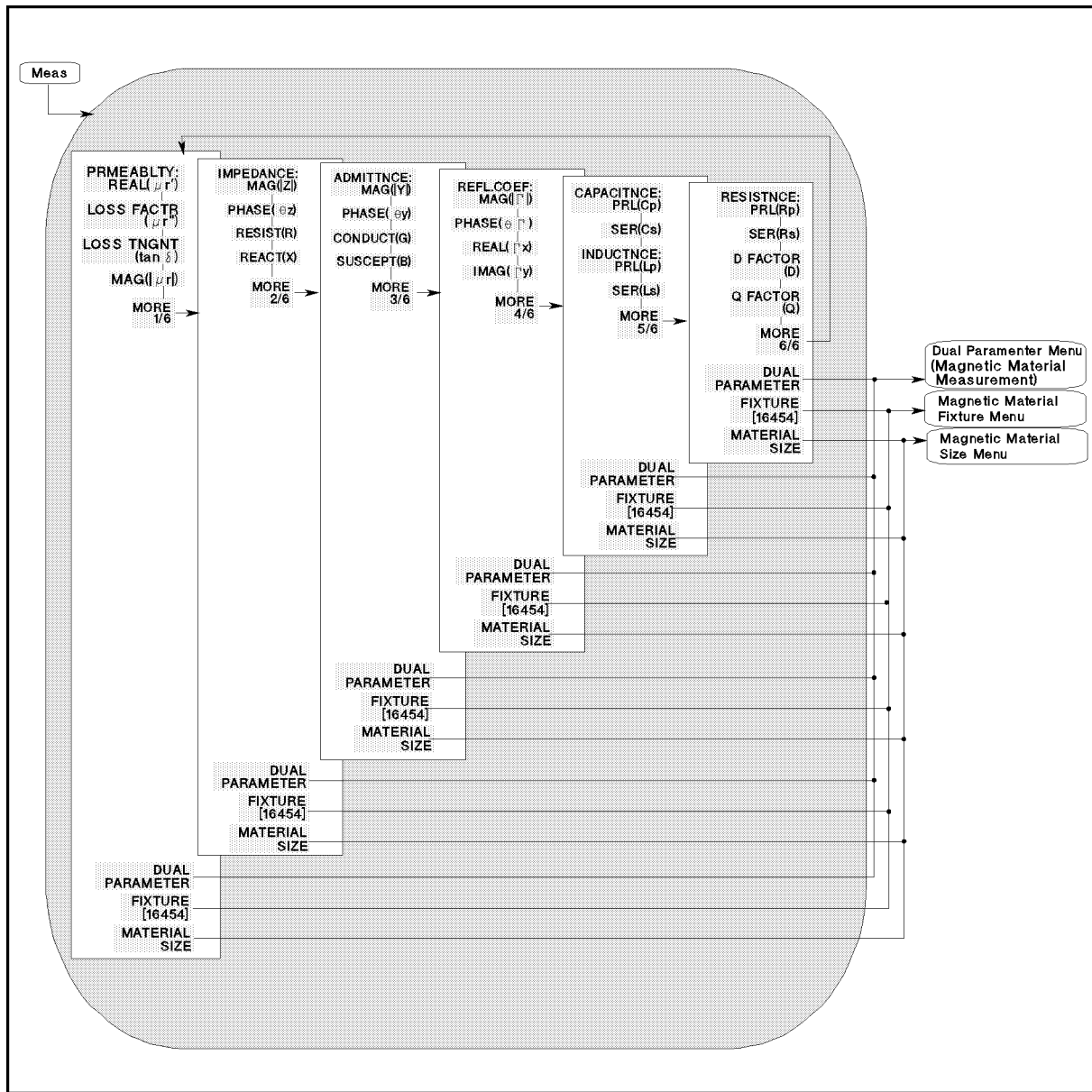

C6005057

Figure 5-19. Permeability Measurement Menu (Option 002 only)

- PRMEABLY: REAL (μ'_r) Measures real part of complex permeability (μ'_r).
- LOSS FACTR (μ''_r) Measures loss factor of complex permeability (μ''_r).
- LOSS TNGNT ($\tan\delta$) Measures loss tangent ($\tan\delta$).
- MAG ($|\mu_r|$) Measures absolute magnitude value of complex permeability ($|\mu_r|$).

Meas (Magnetic Material Measurement)

- **MORE 1/6** leads the following softkeys, which is used to measure impedance parameter as same as the *Impedance Measurement* menu.
 - **IMPEDANCE:MAG(|Z|)** Measures absolute magnitude value of impedance ($|Z|$).
 - **PHASE(θ_z)** Measures phase value of impedance (θ_z).
 - **RESIST(R)** Measures resistance value (R).
 - **REACT(X)** Measures reactance value (X).
 - **ADMITTANCE:MAG(|Y|)** Measures absolute magnitude value of admittance ($|Y|$).
 - **PHASE(θ_y)** Measures phase value of admittance (θ_y).
 - **CONDUCT(G)** Measures conductance value (G).
 - **SUSCEPT(B)** Measures susceptance value (B).
 - **REFL.COEF:MAG(| Γ |)** Measures absolute magnitude value of reflection coefficient ($|\Gamma|$).
 - **PHASE(θ_Γ)** Measures phase value of reflection coefficient (θ_Γ).
 - **REAL(Γ_x)** Measures real part of reflection coefficient (Γ_x).
 - **IMAG(Γ_y)** Measures imaginary part of reflection coefficient (Γ_y).
 - **CAPCITANCE:PRL(C_p)** Measures parallel capacitance (C_p), which is used for small capacitance measurement.
 - **SER(C_s)** Measures series capacitance (C_s), which is used for large capacitance measurement.
 - **INDUCTANCE:PRL(L_p)** Measures parallel inductance (L_p), which is used for large inductance measurement.
 - **SER(L_s)** Measures series inductance (L_s), which is used for small inductance measurement.
 - **RESISTANCE:PRL(R_p)** Measures parallel resistance (R_p), which is used for large resistance, large inductance, or small capacitance.
 - **SER(R_s)** Measures series resistance (R_s), which is used for small resistance, small inductance, or large capacitance.
 - **D FACTOR (D)** Measures dissipation factor (D).
 - **Q FACTOR (Q)** Measures quality factor (Q).
- **DUAL PARAMETER** Leads to the *Dual Parameter menu*, which are used to select parameters to be measured for both channels with one-key stroke.
- **FIXTURE [16454()]** Leads to the *Fixture Menu*, which is used to select the test fixture used with the analyzer. The selected test fixture is displayed in brackets in the softkey label.
- **MATERIAL SIZE** Leads to the *Material Size Menu*, which is used to set the diameters of the magnetic material to be measured.

Complex Permeability Measurement Menu (Option 002 only)

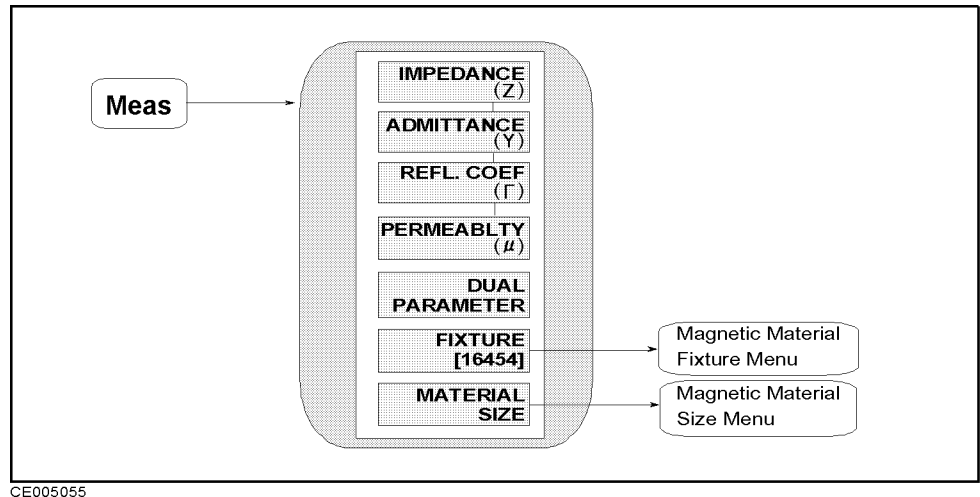

CE005055

Figure 5-20. Complex Permeability Measurement Menu (Option 002 only)

This softkey menu can be accessed at the following conditions:

- Format : the polar, Smith, admittance, or complex plane format is selected.
- Fixture : 16454A is selected.

- **IMPEDANCE (Z)** Measures complex impedance on the polar or complex plane format. This softkey is not available when Smith or admittance chart is selected.
- **ADMITTANCE (Y)** Measures complex admittance on the polar or complex plane format. This softkey is not available when Smith or admittance chart is selected.
- **REFL. COEF (Γ)** Measures complex impedance on Smith, admittance, polar or complex plane format.
- **PERMEABILITY (μ)** Measures complex relative permeability on the polar or complex plane format. This softkey is not available when Smith or admittance chart is selected.
- **DUAL PARAMETER** This softkey is not available for Smith, admittance, polar chart, and complex plane formats.
- **FIXTURE []** Leads to the *Fixture Menu*, which is used to select the test fixture used with the analyzer. The selected test fixture is displayed in brackets in the softkey label.
- **MATERIAL SIZE** Leads to the *Material Size Menu*, which is used to set the diameters of the magnetic material to be measured.

Dual Parameter Menu (Magnetic Material Measurement)

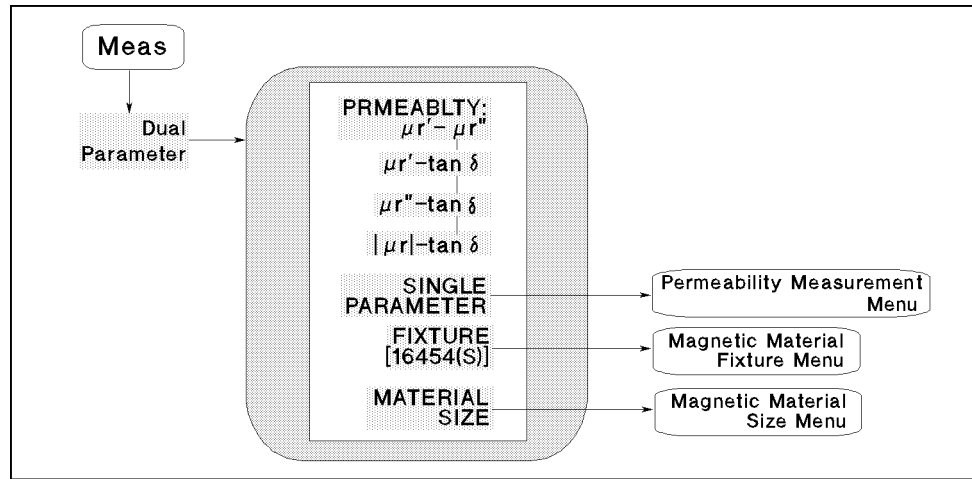
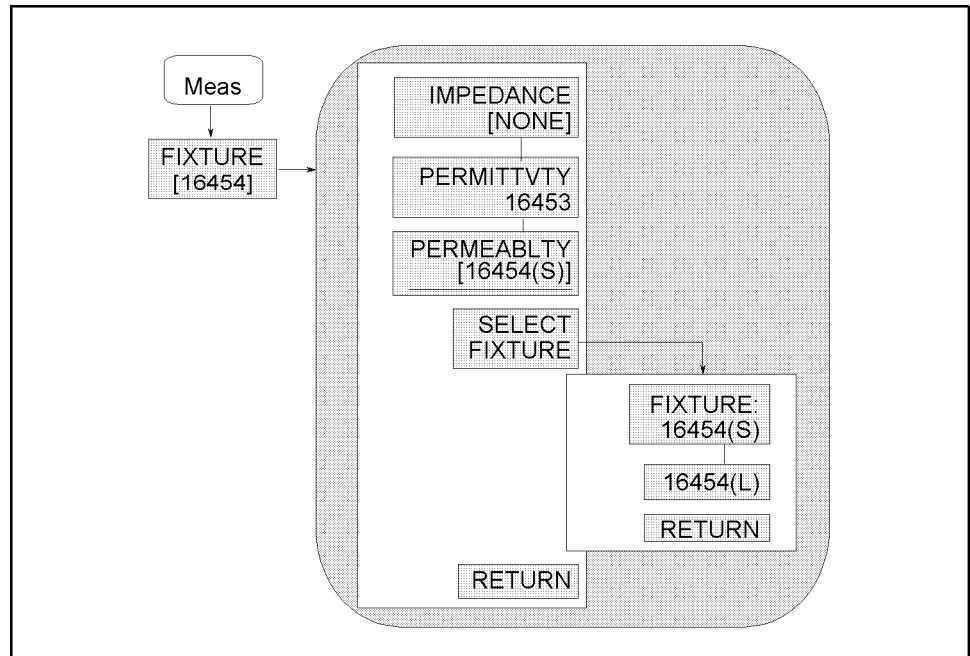

Figure 5-21.
Dual Parameter Menu (Magnetic Material Measurement)

- $\mu_r' - \mu_r''$ Measures μ_r' on channel 1 and measures μ_r'' on channel 2.
- $\mu_r' - \tan \delta$ Measures μ_r' on channel 1 and measures $\tan \delta$ on channel 2.
- $\mu_r'' - \tan \delta$ Measures μ_r'' on channel 1 and measures $\tan \delta$ on channel 2.
- $|\mu_r| - \tan \delta$ Measures $|\mu_r|$ on channel 1 and measures $\tan \delta$ on channel 2.
- SINGLE PARAMETER Leads to the *Permeability Measurement Menu*.
- FIXTURE [16454] Leads to the *Magnetic Material Fixture Menu*, which is used to select test fixture used with the analyzer. The selected test fixture is displayed in brackets in the softkey label.
- MATERIAL SIZE Leads to the *Material Size Menu*, which is used to set the diameters of the magnetic material to be measured.

Magnetic Material Fixture Menu (Option 002 only)



CE005038

Figure 5-22. Magnetic Material Fixture Menu (Option 002 only)

This section describes the softkeys that can be accessed when Option 002 (Material Measurement) is installed and **PERMEABILITY 16454** is selected in this menu.

- **IMPEDANCE []** Selects the impedance measurement. When this softkey is selected, the menu accessed from the **SELECT FIXTURE** softkey lists only impedance fixtures. The (Meas) and (Cal) keys lead only to the menus related to the impedance measurement. When a fixture has been specified, its label is displayed in brackets in the softkey label.
- **PERMITTVTY 16453** Selects the permittivity measurement. This function doesn't set the electrical length. When this softkey is selected, the (Meas) and (Cal) keys lead only to the menus related to the permittivity measurement.
- **PERMEABILITY 16454()** Selects the permeability measurement. When this softkey is selected, the menu accessed from the **SELECT FIXTURE** softkey lists only magnetic material fixtures. The (Meas) and (Cal) keys lead only to the menus related to the permeability measurement. When a fixture size has been specified, the size is displayed in parenthesis in the softkey label.
- **SELECT FIXTURE** Leads to the following softkeys, which are used to select a test fixture for the permeability measurement.
 - **FIXTURE:16454(S)** Sets the electrical length that is suitable for the 16454A Small.

Meas (Magnetic Material Measurement)

- 16454(L) Sets the electrical length that is suitable for the 16454A Large.

Magnetic Material Size Menu (Option 002 only)

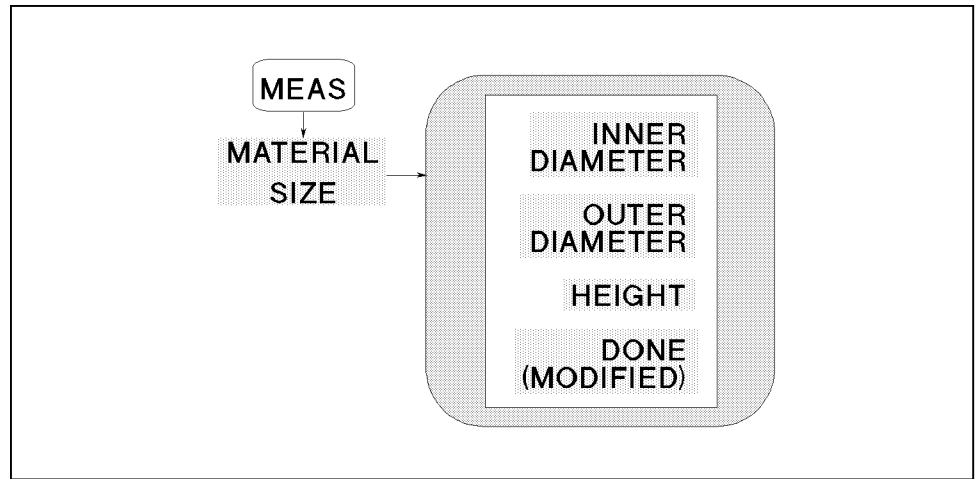

06005040

Figure 5-23. Magnetic Material Size Menu (Option 002 only)

- **OUTER DIAMETER** Sets outer diameter of magnetic material to be measured, which is ring shaped.
- **INNER DIAMETER** Sets inner diameter of magnetic material to be measured, which is ring shaped.
- **HEIGHT** Sets height of magnetic material to be measured, which is ring shaped.
- **DONE (MODIFIED)** Completes the procedure to define material size.

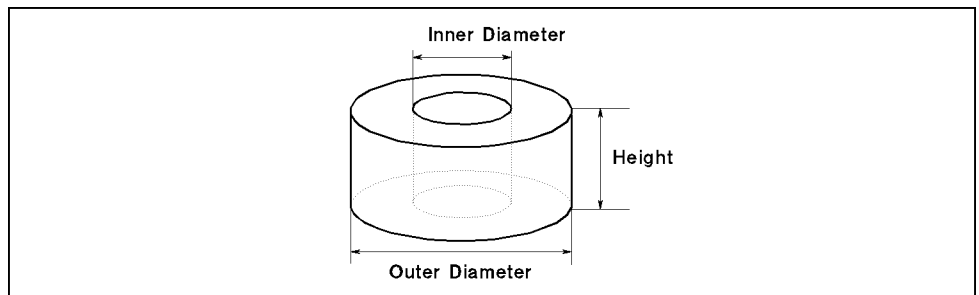

06011079

Figure 5-24. Magnetic Material Size

Format Menu

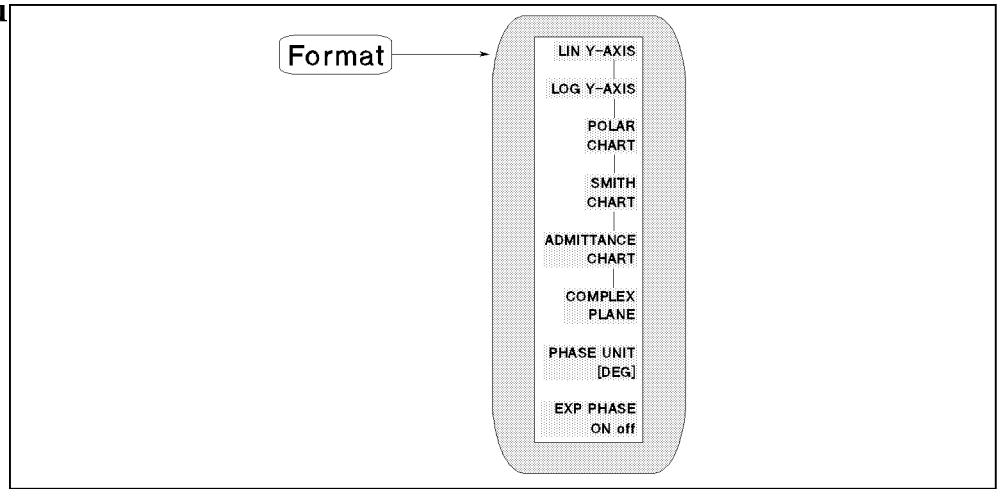

Figure 5-25. Format Menu

- **LIN Y-AXIS** Displays the linear magnitude format.
- **LOG Y-AXIS** Displays the log scale format.
- **POLAR CHART** Displays a polar chart format.
- **SMITH CHART** Displays a Smith chart format.
- **ADMITTANCE CHART** Displays an admittance Smith chart format.
- **COMPLEX PLANE** Displays a complex plane format.
- **PHASE UNIT []** Selects the unit for phase measurement. The unit selected is shown in brackets.
- **EXP PHASE ON off** Turns the expanded phase ON or OFF. When this is turned OFF, the analyzer wraps the phase plot around every $\pm 180^\circ$. When this is ON, the analyzer avoids the wrap and displays the phase plot over $\pm 180^\circ$.

Note

After change the format, you should select the measurement parameter again as a right one.

User Trace Format Menu

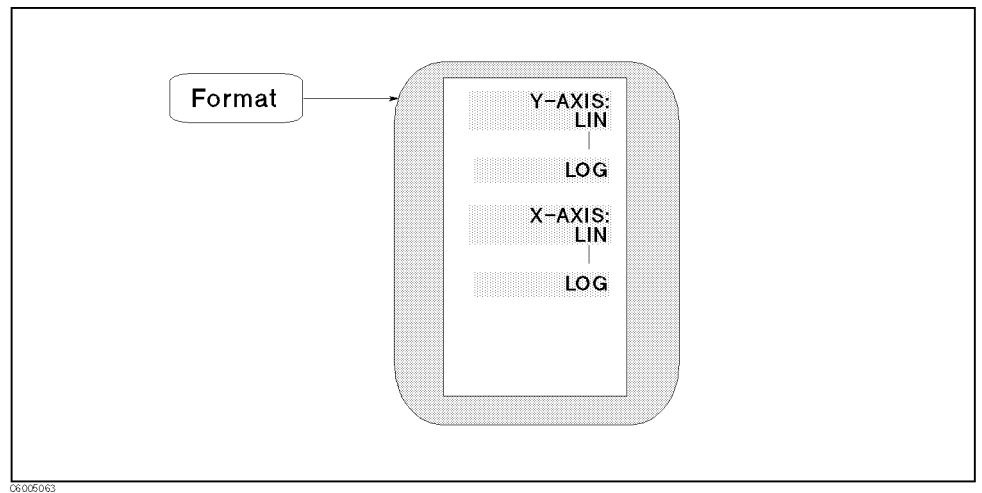

Figure 5-26. User Trace Format Menu

This menu can be accessed when the user trace is turned on.

- **Y-AXIS: LIN** Selects linear scale along the y-axis.
- **LOG** Selects logarithm scale along the y-axis.
- **X-AXIS: LIN** Selects linear scale along the x-axis.
- **LOG** Selects logarithm scale along the x-axis.

Display

Display

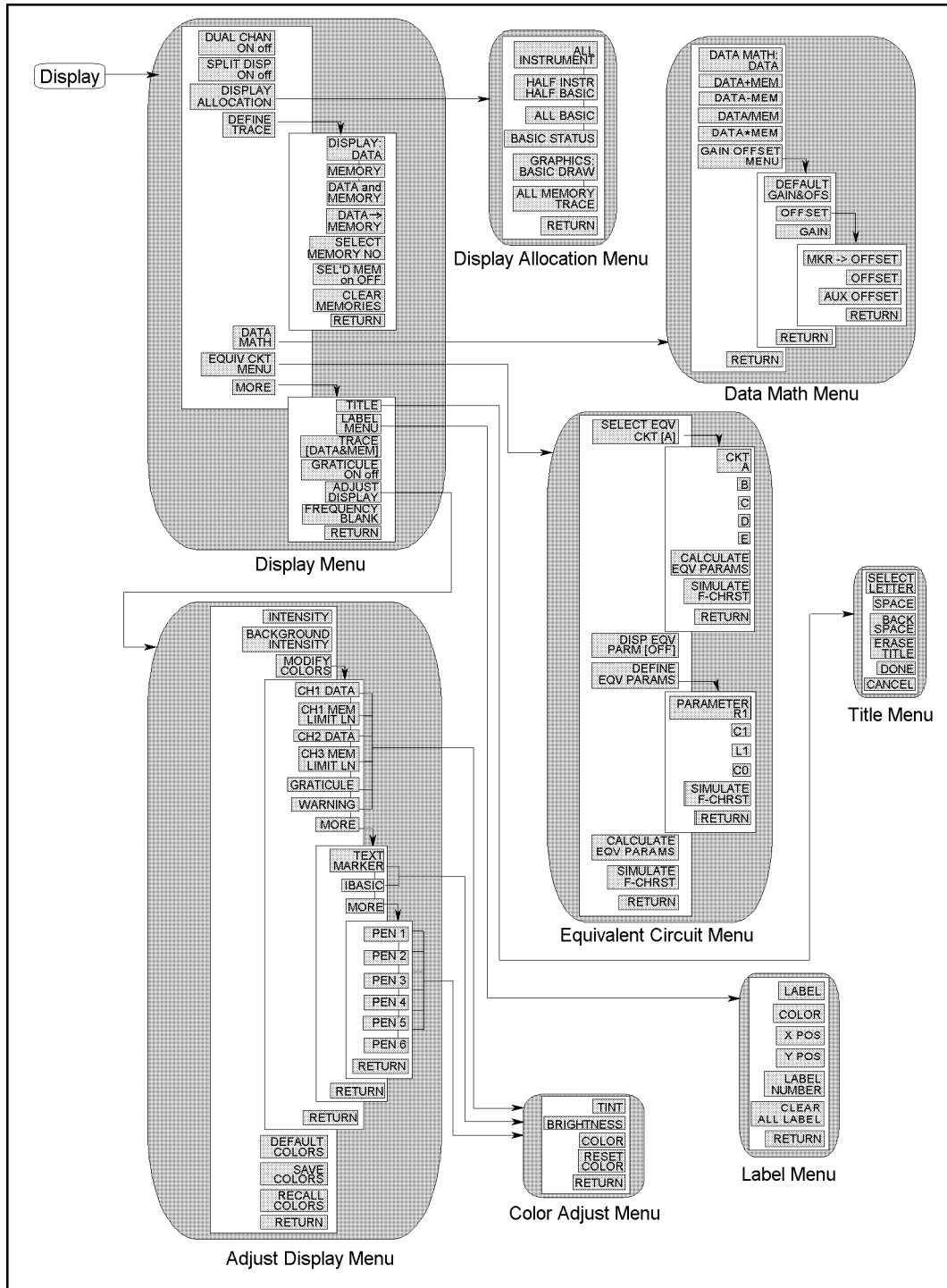

CE005017

Figure 5-27. Softkey Menu Accessed from **Display** Key

Display Menu

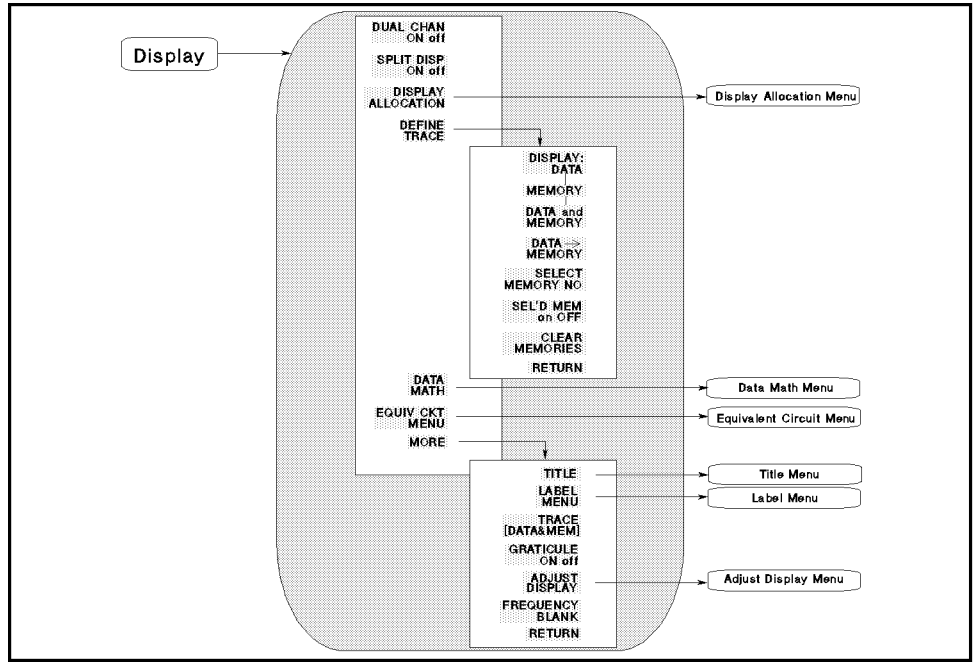

Figure 5-28. Display Menu

- **DUAL CHAN ON off** Toggles between the display of both measurement channels or the active channel only. This is used in conjunction with **SPLIT DISP ON off** to display both channels.
- **SPLIT DISP ON off** Toggles between a full-screen single graticule display of one or both channels, and a split display with two half-screen graticules one above the other. The split display can be used in conjunction with **DUAL CHAN ON** to show the measured data of each channel simultaneously on separate graticules.
- **DISPLAY ALLOCATION** Displays the *Display Allocation menu*, which is used to allocate the BASIC screen area on the display.
- **DEFINE TRACE** Leads to the following softkeys, which are used to select traces displayed (the data trace and the memory traces).
 - **DISPLAY: DATA** Displays the current measurement data trace for the active channel.
 - **MEMORY** Displays the trace memory for the active channel. If no data is stored in memory for this channel, a warning message is displayed.
 - **DATA and MEMORY** Displays both the current data and the memory traces.
 - **DATA->MEMORY** Stores the current active measurement data in the active memory of the active channel. It then becomes the memory trace (for use in subsequent math manipulations or display). When the NOP is changed, the memory trace becomes invalid.
 - **SELECT MEMORY NO** Selects a memory trace as the active memory trace. The analyzer can store traces into several memory traces (maximum number of memory traces depends on the NOP). However, the display functions (such as scaling) and marker functions affect the active memory trace specified by this softkey.

- **SEL'D MEM ON off** Sets the state of the memory trace always to display the memory trace or to erase the memory trace, even each memory trace is inactive. (Regardless of this setting, the active memory trace is always displayed.) The state of each memory trace can be set to display or erase traces individually, and pressing this key changes the state of the current active memory trace selected by **SELECT MEMORY NO** . Therefore, it is necessary to select a memory trace before changing this state. See the following example:

For example: To erase memory trace No.2

Assuming that two memory traces have been used:

1. Press **SELECT MEMORY NO** **(2)** **(X1)**. (No.2 memory trace is selected)
2. Press **SEL'D MEM ON off** to turn to off. (Softkey label will change from **ON off** to **on OFF**. No.2 memory trace is set to be erased when another trace is selected.)
3. Press **SELECT MEMORY NO** **(1)** **(X1)**. (NO.1 memory trace is selected and No.2 memory trace is not displayed.)

If you cannot display memory traces . . .

1. When you cannot turn on **MEMORY** or **DATA** and **MEMORY** .

In this case, check if the softkey labels of **MEMORY** and **DATA** and **MEMORY** are dim. If they are dim, no data is stored in the memory trace. Press **(Display)** **DEFINE TRACE DATA—MEMORY** to store data into the memory trace before turning on the memory trace.
2. When a memory trace selected using **SELECT MEMORY NO** can be displayed, but other memory traces cannot be displayed.

In this case, please check if the softkey label of **SEL'D MEM ON off** is dim, if it is dim, press **(Display)** **DISPLAY ALLOCATION ALL MEMORY TRACE** to make all memory traces available.

- **CLEAR MEMORY** Clear all memory traces.

The analyzer will lose all data in the memory traces after you press this softkey. If the memory traces are to be recalled, you must save the data to the floppy disk or the memory disk.

The following operations also clear the memory traces:

- Pressing **(Preset)**.
- Turning the analyzer off.
- Changing NOP.
- Recalling data from the floppy disk or memory disk.

Pressing **SIMULATE F-CHAR** in the *Equivalent Circuit menu* changes the data in memory trace NO.1 because the equivalent circuit function uses this memory trace in order to display the result of simulating the frequency characteristics.

- **DATA MATH** Leads to the *Data Math Menu*. The data math function selected is shown in brackets ([DATA–MEM] shows that the data math function selected DATA–MEM).
- **EQUIV CKT MENU** Leads to the *Equivalent Circuit menu*, which is used to derive values of equivalent circuit parameters and simulate frequency characteristics of equivalent circuits.
- **TITLE** Displays the title menu in the softkey labels and the character set in the active entry area to display the title in the active channel title area on the screen.
- **LABEL MENU** Leads to the *Label menu*, which is used to label text on any area of the screen.
- **TRACE []** Turns the user trace display on or off. When the user traces are turned on, the normal data/memory trace is not displayed.

[USER] shows the user trace is displayed

[DATA&MEM] shows the normal data trace is displayed

- **GRATICULE ON off** Turns the graticule of the active channel on or off.

If the graticule is not erased when GRATICULE ON off is turned off

When Dual channel is on, Split display is off, and both channels are using the same format, the graticule is not erased, even if the graticule setting of either channel is tuned off. In this case, turn the GRATICULE ON off of both channels to off.

When a user trace is displayed, the graticule cannot be erased using GRATICULE ON off.

- **ADJUST DISPLAY** Provides a menu for adjusting display intensity, colors, and accessing save and recall functions for modified display color sets.
- **FREQUENCY BLANK** Blanks the displayed frequency notation for security purposes. Frequency labels cannot be restored except by pressing (Preset) or by turning the power off and then on.

Display Allocation Menu

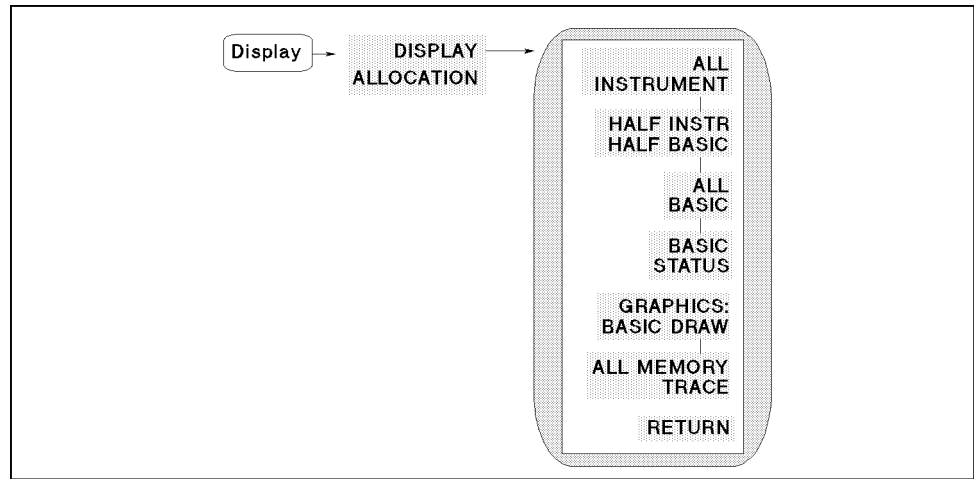
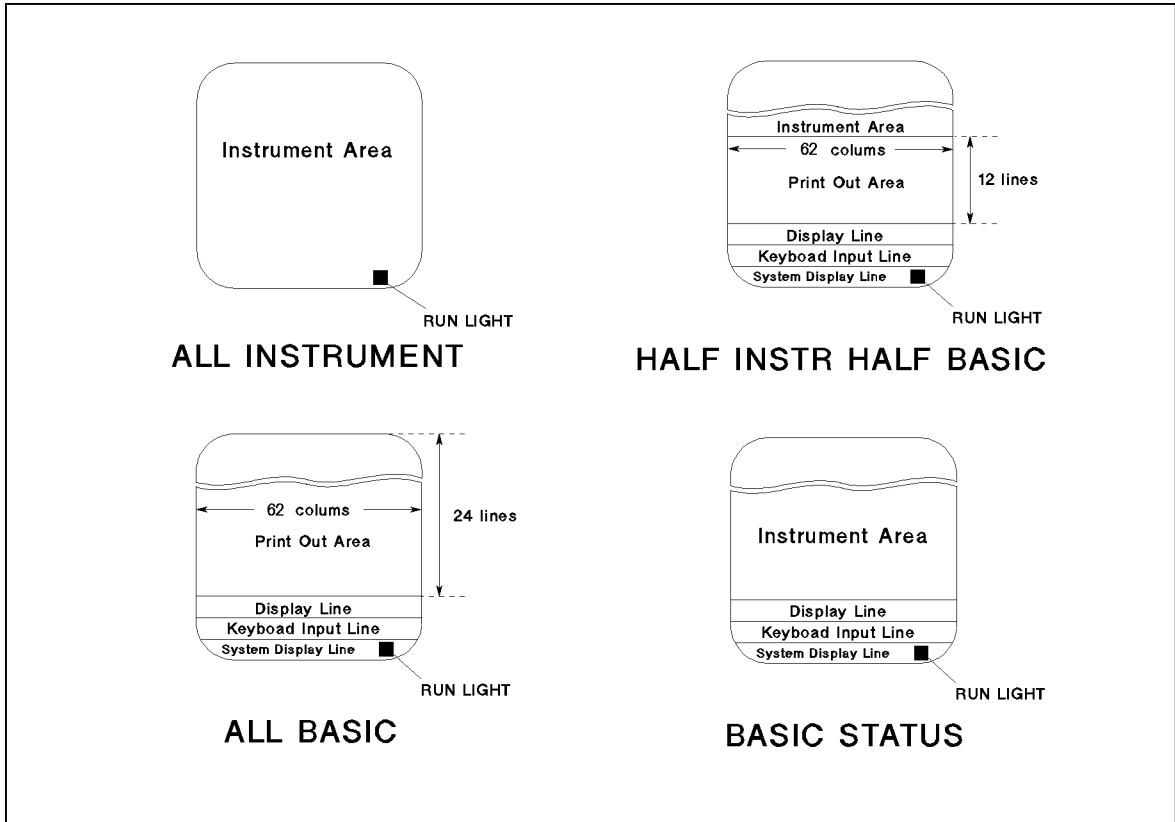

Figure 5-29. Display Allocation Menu

- **ALL INSTRUMENT** Selects a full screen or two half-screen graticules.
- **HALF INSTR HALF BASIC** Selects two half-screens, one graticule display above the HP Instrument BASIC display.
- **ALL BASIC** Selects a full screen single HP Instrument BASIC display.
- **BASIC STATUS** Selects a full screen graticule and three status lines for HP Instrument BASIC under the graticule.
- **GRAPHICS: BASIC DRAW** Makes Instrument BASIC graphic capability available. Because the Instrument BASIC graphic capability uses the same resources as the memory trace capability, the analyzer cannot display memory traces except for a memory trace selected using **SELECT MEMORY NO** when this softkey is selected.
- **ALL MEMORY TRACE** Makes all memory trace displays available. Because the multiple memory trace display capability uses the same resources as the Instrument BASIC graphic capability, the analyzer cannot display Instrument BASIC graphics when this softkey is selected.



C560C001

Figure 5-30. Display Allocations

Data Math Menu

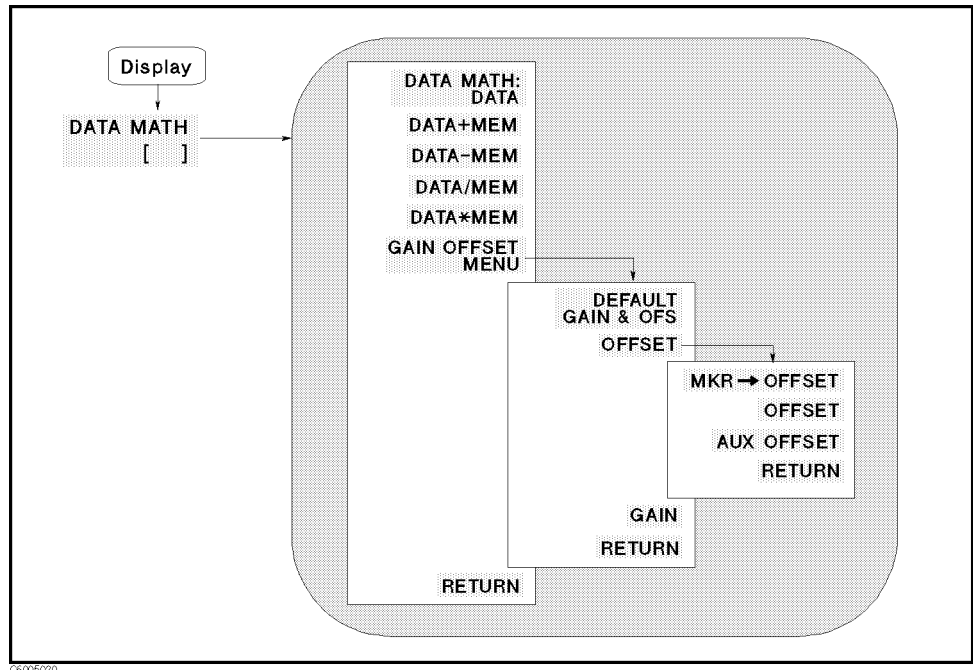

Figure 5-31. Data Math Menu

- **DATA** Turns off all data math functions.
- **DATA+MEM** Adds the memory trace to the data trace.
- **DATA-MEM** Subtracts the memory trace from the data trace.
- **DATA/MEM** Divides the data trace by the memory trace.
- **DATA*MEM** Multiplies the data trace by the memory trace.
- **GAIN OFFSET MENU** Leads to the following softkeys, which are used to set gain and offset values for the data math function.
 - **DEFAULT GAIN & OFS** Returns gain and offset value back to the default values (gain=1, offset=0).
 - **OFFSET** Displays the menu used to define the offset value and activates the offset value. When using Smith, polar, admittance chart, and complex plane format, **OFFSET** defines the real part of the offset value.
 - **MKR→OFFSET** Enters the marker's amplitude value into the offset value.
 - **OFFSET** Makes the offset value the active function.
 - **AUX OFFSET VALUE** Defines the imaginary part of the offset value when using the Smith, polar, admittance chart, and complex plane format. If the format is not one of the above formats, this softkey performs no function.
 - **GAIN** Defines the gain value for the data math function.

The data math functions displays the result of the following calculations:

- $(GAIN \times DATA) - OFFSET$
- $(GAIN \times MEMORY) - OFFSET$
- $(GAIN \times (DATA + MEMORY)) - OFFSET$
- $(GAIN \times (DATA - MEMORY)) - OFFSET$
- $(GAIN \times (DATA / MEMORY)) - OFFSET$
- $(GAIN \times (DATA \times MEMORY)) - OFFSET$

Where,

GAIN is a scalar value defined by **GAIN**

DATA is the data trace value (measurement value)

MEMORY is the memory trace value (stored by **DATA—MEMORY**)

OFFSET is an offset value defined by **OFFSET**

Equivalent Circuit Menu

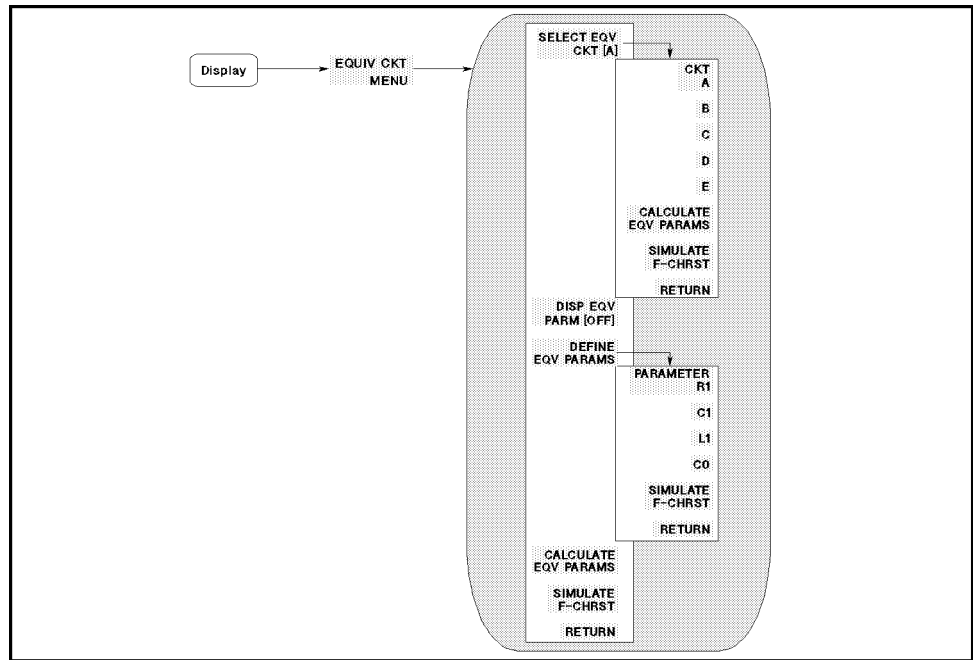
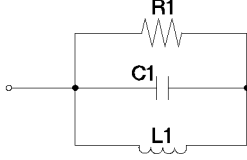
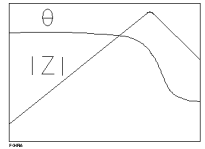
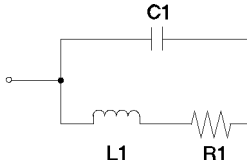
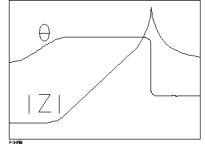
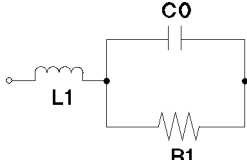
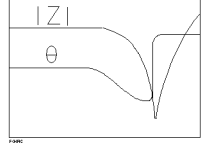
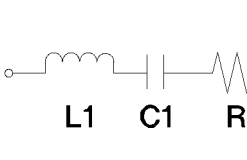
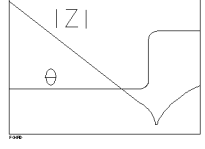
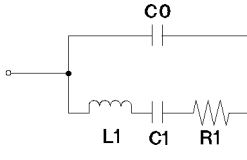
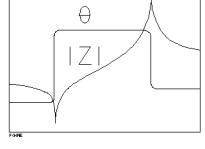

Figure 5-32. Equivalent Circuit Menu

- **SELECT EQV CIRCUIT** Leads to the following softkeys, which are used to select the equivalent circuit. (See Table 5-1.)
 - **A** Selects equivalent circuit A, which is used to simulate inductors with high core loss.
 - **B** Selects equivalent circuit B, which is used to simulate inductors in general and resistors.
 - **C** Selects equivalent circuit C, which is used to simulate high-value resistors.
 - **D** Selects equivalent circuit D, which is used to simulate capacitors.
 - **E** Selects equivalent circuit E, which is used to simulate resonators.
- **CALCULATE EQV PARAMS** Calculates the equivalent circuit parameters. While the calculation is being performed, the message Calculating EQV parameters is displayed. After the calculation is completed, the values of the equivalent parameters are displayed.
- **DEFINE EQV PARMS** Leads to the following softkeys, which are used to enter the equivalent circuit parameters.
 - **PARAMETER R1** makes R_1 the active function in order to enter its value.
 - **L1** makes L_1 the active function in order to enter its value.
 - **C0** makes C_0 the active function in order to enter its value.
 - **C1** makes C_1 the active function in order to enter its value.

- **SIMULATE F-CHRST** Simulates the frequency characteristics by using the current equivalent circuit parameters and shows simulation result on the screen using memory trace NO.1. In other words, simulation results are stored into the NO.1 memory trace.
- **DISP EQV PARM [ON]** Toggles the display of the equivalent circuit parameter value.

Table 5-1. Equivalent Circuit Selection Guide

	Equivalent Circuit	Type of devices	Typical Frequency Characteristics
A		inductors with high core loss	
B		inductors and resistors	
C		high-value resistors	
D		capacitors	
E		resonators	

Note



The equivalent circuit function is available only for the frequency sweep. The equivalent circuit function is not available for OSC level and dc bias sweep. You should set the resonant frequency in the sweep range to get the right result.

Analysis Range can be specified

The frequency range used to calculate parameters can be specified using the menu accessed from the **SEARCH RANGE MENU** under the **Search** key.

Adjust Display Menu

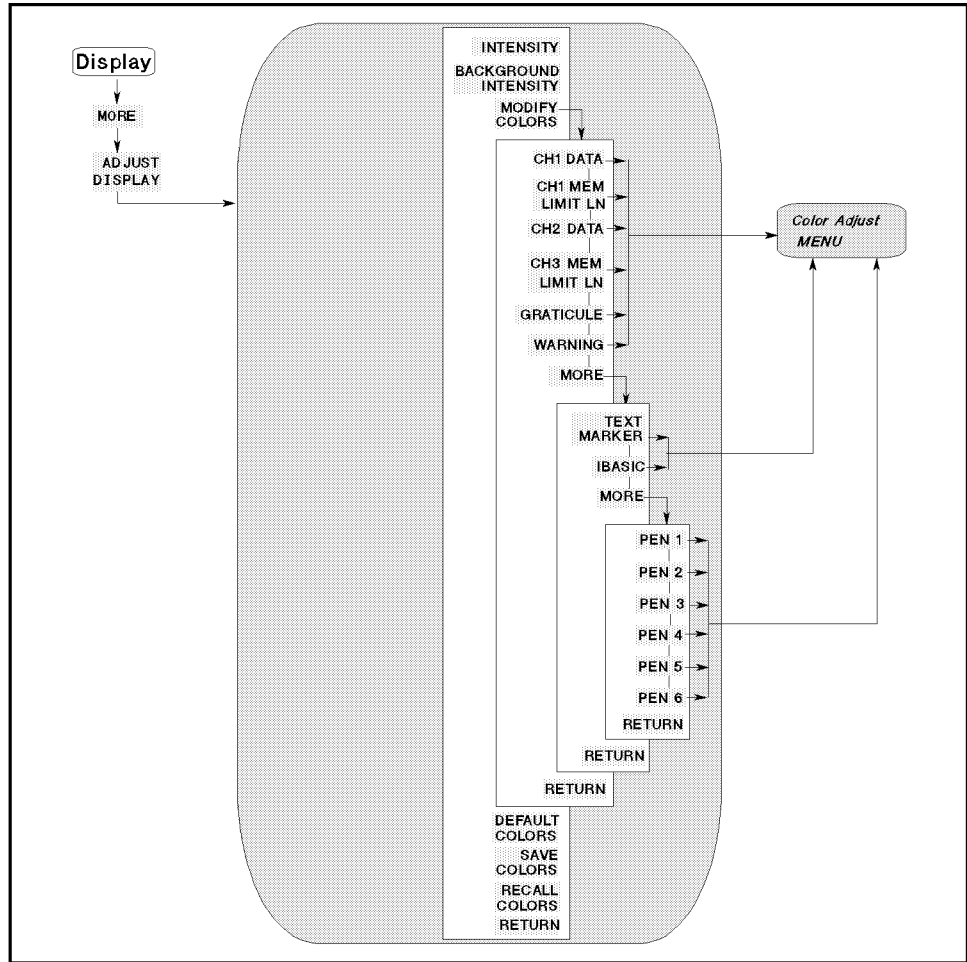

Figure 5-33. Adjust Display Menu

- **INTENSITY** Sets the display intensity as a percentage of the brightest setting.
- **BACKGROUND INTENSITY** Sets the background intensity of the display as a percentage of the white level.
- **MODIFY COLORS** Displays the menu used for color modification of the display elements.
 - **CH1 DATA** Selects channel 1 data trace for color modification and displays the *Color Adjust menu*.
 - **CH1 MEM/LIMIT LINE** Selects channel 1 memory trace and limit lines for color modification and displays the *Color Adjust menu*.
 - **CH2 DATA** Selects channel 2 data trace for color modification and displays the *Color Adjust menu*.
 - **CH2 MEM/LIMIT LINE** Selects channel 2 memory and the reference line and limit line for color modification and displays the *Color Adjust menu*.
 - **GRATICULE** Selects the graticule and a portion of softkey text (where there is a choice of a feature being ON or OFF) for color modification and displays the *Color Adjust menu*.

- **WARNING** Selects the warning annotation for color modification and displays the *Color Adjust menu*.

MORE (in this menu) displays softkeys to select other elements for color modification.

- **TEXT MARKER** Selects all the non-data text for color modification (for example, softkey labels) and displays the *Color Adjust menu*.
 - **IBASIC** Selects the text on the BASIC screen for color modification and displays the *Color Adjust menu*.
- MORE** (in this menu) displays softkeys to select a numbered pen for color modification. The pens are used by the HP Instrument BASIC graphic commands.
- **PEN 1** Selects pen 1 for color modification and displays the *Color Adjust menu*.
 - **PEN 2** Selects pen 2 for color modification and displays the *Color Adjust menu*.
 - **PEN 3** Selects pen 3 for color modification and displays the *Color Adjust menu*.
 - **PEN 4** Selects pen 4 for color modification and displays the *Color Adjust menu*.
 - **PEN 5** Selects pen 5 for color modification and displays the *Color Adjust menu*.
 - **PEN 6** Selects pen 6 for color modification and displays the *Color Adjust menu*.
- **DEFAULT COLORS** Returns all the color settings back to the default values.
 - **SAVE COLORS** Saves the modified version of the color set to the non-volatile memory.
 - **RECALL COLORS** Recalls the previously saved modified version of the color set from the non-volatile memory. **RECALL COLORS** appears only when a color set has been saved.

Color Adjust Menu

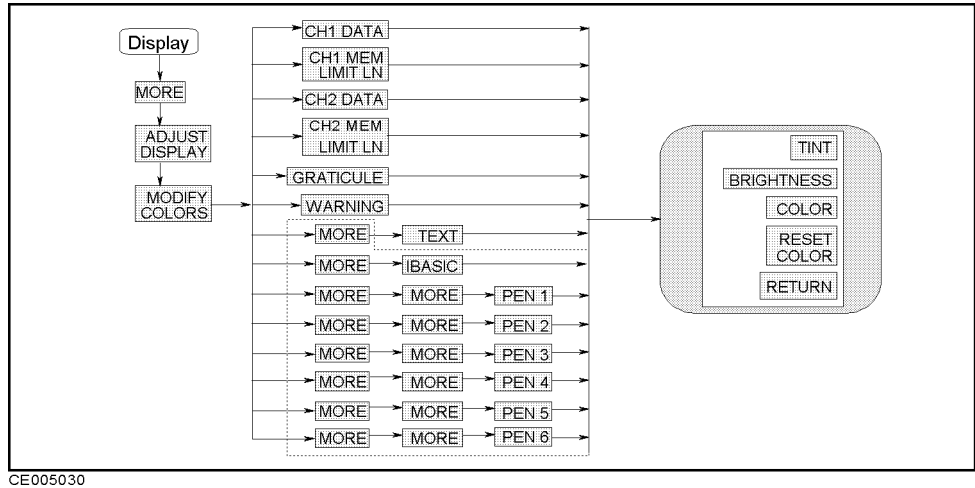

CE005030

Figure 5-34. Color Adjust Menu

- **TINT** Adjusts the hue of the chosen attribute.
- **BRIGHTNESS** Adjusts the brightness of the color being modified.
- **COLOR** Adjusts the degree of whiteness of the color being modified.
- **RESET COLOR** Resets the color being modified to the default color.

Color consists of the following three parameters:	
Tint	The continuum of hues on the color wheel, ranging from red through green and blue, and back to red.
Brightness	A measure of the brightness of the color.
Color	The degree of whiteness of the color. A scale from white to pure color.

Label Menu

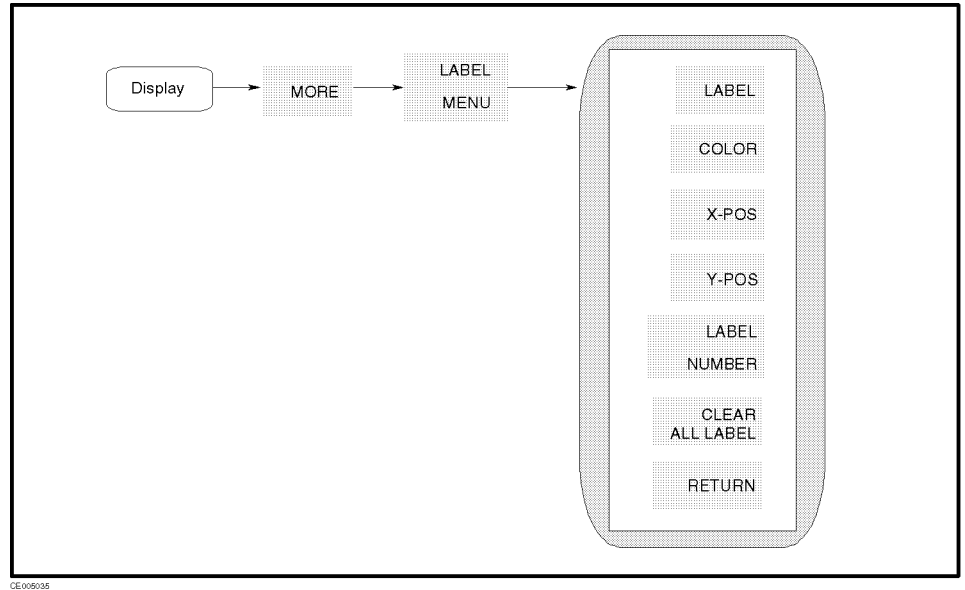

CE009035

Figure 5-35. Label Menu

- **LABEL** Makes label the active function to define the label.
- **COLOR** Selects the color of the label text.
- **X-POS** Sets the X-axis position of the label selected by **LABEL NUMBER**.
- **Y-POS** Sets the Y-axis position of the label selected by **LABEL NUMBER**.
- **CLEAR ALL LABEL** Clear all label.
- **LABEL NUMBER** Select the number of labels.

Display

Title menu

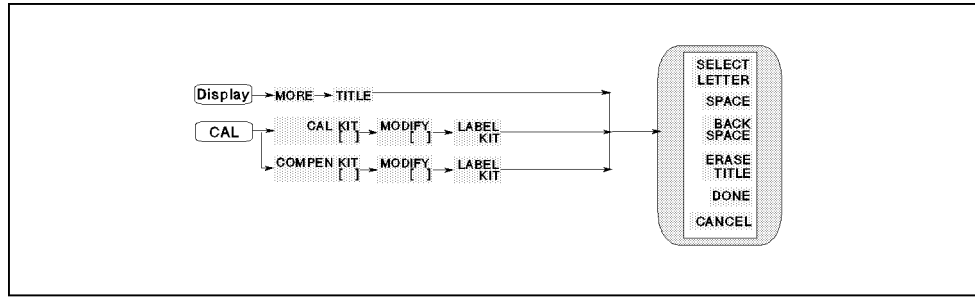
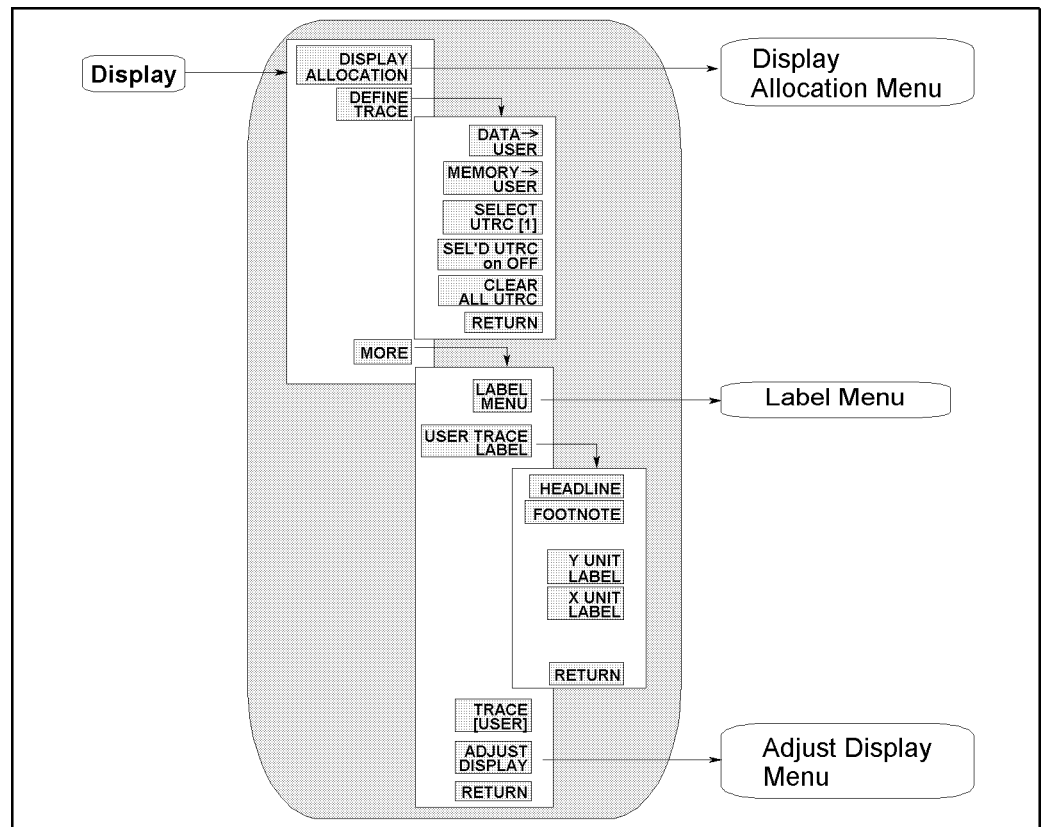

Figure 5-36. Title Menu

- **SELECT LETTER** Selects the letter pointed to by the arrow “↑” on the screen. The arrow can be moved by rotating the knob.
- **SPACE** Inserts a space in the title.
- **BACK SPACE** Deletes the last character entered.
- **ERASE TITTLE** Deletes the entire title.
- **DONE** Terminates the title entry and returns to the display more menu.
- **CANCEL** Cancels the title entry and returns to the display more menu without any change.

User Trace Display Menu



CE005062

Figure 5-37. User Trace Display Menu

This menu can be accessed when the user trace is turned on.

- **DISPLAY ALLOCATION** Displays the *Display Allocation menu*, which is used to allocate the BASIC screen area on the display.
- **DEFINE TRACE** Leads to the following softkeys, which are used to select traces displayed (the data and memory traces and the user trace).
 - **DATA→USER** Stores the active measurement data in the user trace selected and copies the unit and NOP of the data trace to the user trace selected.
 - **MEMORY→USER** Stores the active memory data in the user trace selected and copies the unit and NOP of the memory trace to the user trace selected.
 - **SELECT UTRC [1]** Leads to the following softkeys, which are used to select one user trace from the four traces available in order to copy data or memory trace to the user trace. You can read the value of the trace using the marker and scale the trace.
 - **USER TRC 1** Selects user trace number 1.
 - **USER TRC 2** Selects user trace number 2.

- **USER TRC 3** Selects user trace number 3.
- **USER TRC 4** Selects user trace number 4.
- **SEL'D UTRC ON off** Sets the state of the selected user trace to display it (ON) or to erase it (OFF). The trace is not displayed when the trace is unselected after the state was set to OFF. The state of each user trace can be set ON and OFF individually.
- **CLEAR ALL UTRC** Clears all user trace data and settings, and turns off the user trace display.
- **MORE** Leads the following softkey menu.
 - **LABEL MENU** Leads to the *Label menu*, which is used to label text on any area of the screen.
 - **USER TRACE LABEL** Displays the following softkeys, which are used to put characters on the top or bottom area, or to enter the x and y axis unit labels of the user trace display screen.
 - **HEADLINE** Displays the *Letter menu* to enter characters for a headline at the top left corner of the user trace display screen. The headline can be defined for each user trace individually.
 - **FOOTNOTE** Displays the *Letter menu* to enter characters as a footnote at the bottom of the user trace display screen. The footnote can be defined for each user trace individually.
 - **X UNIT LABEL** Displays the *Letter menu* to enter the x-axis unit label of a current selected user trace.
 - **Y UNIT LABEL** Displays the *Letter menu* to enter the y-axis unit label of a current selected user trace.
 - **TRACE []** Turns the user trace display on or off. When the user traces are turned on, the normal data/memory trace is not displayed.

[USER] shows the user trace is displayed

[DATA&MEM] shows the normal data trace is displayed

- **ADJUST DISPLAY** Provides a menu for adjusting display intensity, colors, and accessing save and recall functions for modified display color sets.

Scale Reference Menu

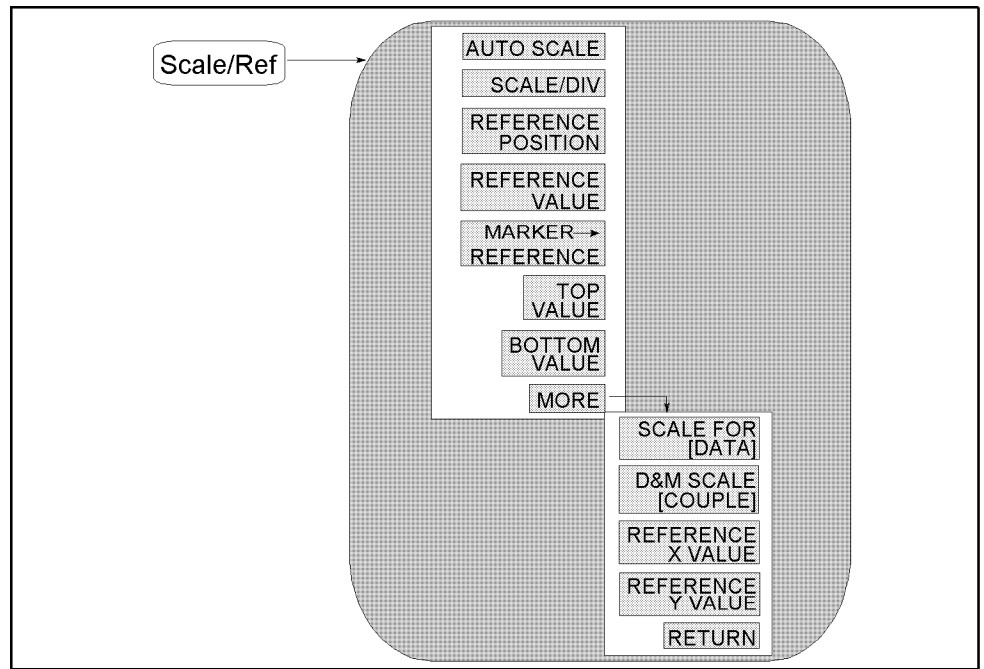

CE005024

Figure 5-38. Scale Reference Menu

- **AUTO SCALE** Brings the trace data (defined by the **SCALE FOR** key) in view on the display with one keystroke. Sweep values are not affected, only scale and reference values. The analyzer determines the smallest possible scale factor that will put all displayed data onto the vertical graticule.
- **SCALE/DIV** Changes the response value scale per division of the displayed trace. In Smith, polar, and admittance chart formats, this refers to the full scale value at the outer circumference and is identical to the reference value.
- **REFERENCE POSITION** Sets the position of the reference line on the graticule of a Cartesian display (with 0 at the bottom line of the graticule and 10 at the top line). It has no effect on a Smith, polar or admittance chart format. The reference position is indicated with a small triangle just outside the graticule, on the left.
- **REFERENCE VALUE** Changes the value of the reference line, moving the measurement trace correspondingly. In Smith, polar and admittance chart formats, the reference value is the same as the scale and is the value of the outer circle.
- **MARKER—REFERENCE** Makes the reference value equal to the marker's absolute value (regardless of the delta marker value). The marker is effectively moved to the reference line position. In Smith, polar and admittance chart formats this function makes the full scale value at the outer circle equal to the marker response value.
- **TOP VALUE** Changes the value at the top line of the graticule, moving the measurement trace correspondingly.

- **BOTTOM VALUE** Changes the value at the bottom line of the graticule, moving the measurement trace correspondingly.
- **REFERENCE X VALUE** Changes the value of the center position of the X axis, moving the measurement trace correspondingly. This softkey is only available for the complex plane format.
- **REFERENCE Y VALUE** Changes the value of the center position of the Y axis, moving the measurement trace correspondingly. This softkey is only available for the complex plane format.
- **SCALE FOR []** Selects one of the “DATA” and “MEMORY” traces to be scaled by prior functions in this menu. The “DATA” and “MEMORY” traces are available using the *Display menu* accessed from the **Display** key. All memory traces are displayed with the same scaling size.
- **D&M SCALE []** Couples or uncouples the “DATA” and “MEMORY” traces to be scaled by prior functions in this menu. This is valid only for those traces obtained by the *Display menu* accessed from the **Display** key.

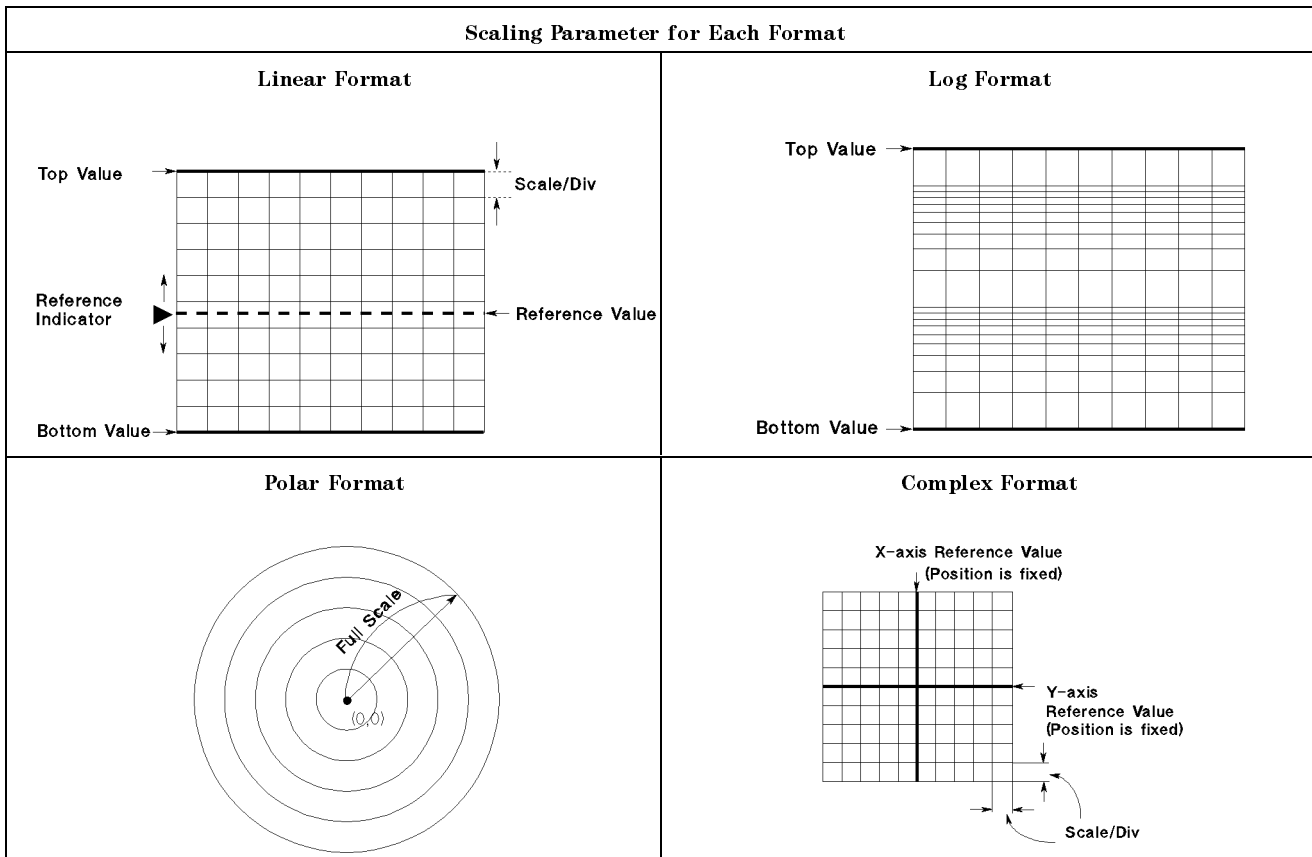

User Trace Scale Menu

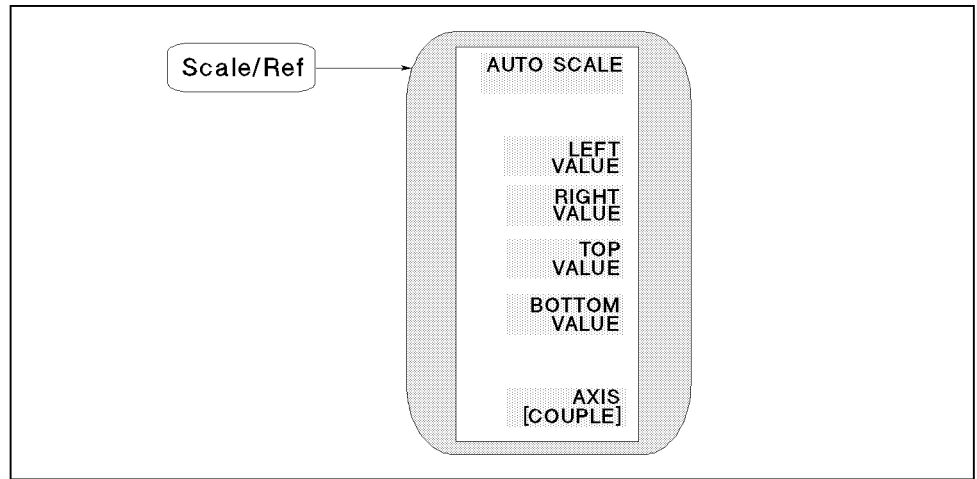

00005064

Figure 5-39. User Trace Scale Menu

This menu can be accessed when the user trace is turned on.

- **AUTO SCALE** Brings the trace data in view on the display with one keystroke. The analyzer determines the smallest possible scale factor that will put all displayed data onto the graticule.
- **LEFT VALUE** Changes the value at the left line of the graticule, moving the current selected user trace correspondingly.
- **RIGHT VALUE** Changes the value at the right line of the graticule, moving the current selected user trace correspondingly.
- **TOP VALUE** Changes the value at the top line of the graticule, moving the current selected user trace correspondingly.
- **BOTTOM VALUE** Changes the value at the bottom line of the graticule, moving the current selected user trace correspondingly.
- **AXIS [COUPLE]** Couples or uncouples all user traces to be scaled along the x and y axes by prior functions in this menu.

[COUPLE] Shows parameters for the x and y axes of all user traces are coupled to the current selected user trace setting.

[UNCUPLE] Shows parameters for the x and y axes of each user trace can be set individually.

Averaging Menu

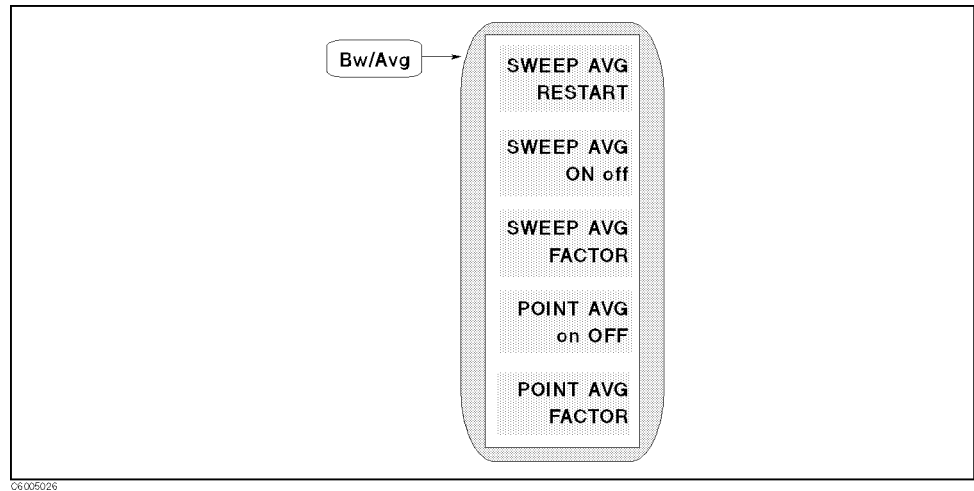

06005026

Figure 5-40. Averaging Menu

- **SWEEP AVG RESTART** Resets the sweep-to-sweep averaging and on-point averaging, and restarts the sweep count at 1 at the beginning of the next sweep. The sweep count for averaging is displayed at the left of the display.
- **SWEEP AVG ON off** Turns the sweep-to-sweep averaging function ON or OFF for the active channel. When averaging is ON, "Avg" is displayed in the status notation area at the left of the display (along with the sweep count for the averaging factor). Whenever an instrument state change affecting the measured data is made, the sweep count for averaging is reset to 1.

At the start of averaging or following **AVERAGING RESTART**, averaging starts at 1 and averages each new sweep into the trace until it equals the specified averaging factor. The sweep count is displayed in the status notation area below "Avg" and updated each sweep as it increments. When the specified averaging factor is reached, the trace data continues to be updated, weighted by that averaging factor.

- **SWEEP AVG FACTOR** Makes the sweep-to-sweep averaging factor the active function. Any value up to 999 can be used.
- **POINT AVG on OFF** Turns the on-point averaging function ON or OFF for the active channel.
- **POINT AVG FACTOR** Makes the point averaging factor the active function. Any value up to 999 can be used.

Averaging On Sweep and Averaging On Points

Averaging On Sweep

Averaging-on-sweep computes each data point based on an exponential average of consecutive sweeps weighted by a user-specified averaging factor. Each new sweep is averaged into the trace until the total number of sweeps is equal to the averaging factor, for a fully averaged trace. Each point on the trace is the vector sum of the current trace data and the data from the previous sweep. A high averaging factor gives the best signal-to-noise ratio, but slows the trace update time. Doubling the averaging factor reduces the noise by 3 dB. The algorithm used for averaging-on-sweep is:

$$A_{(n)} = \frac{S_{(n)}}{F} + \left(1 - \frac{1}{F}\right) \times A_{(n-1)}$$

Where,

$A_{(n)}$ = current average

$S_{(n)}$ = current measurement

F = average factor

Averaging On Points

Averaging-on-points averages each data point by a user-specified averaging factor. The analyzer repeats measuring the same point until the averaging factor is reached. It then divides the vector summation of measurement value by the averaging factor and starts measuring the next point. The sweep time increases in proportion to the averaging factor. The algorithm used for averaging-on-points is:

$$M = \frac{1}{F} \sum_{n=1}^F S_{(n)}$$

Where,

M = Measurement Result

$S_{(n)}$ = current measurement

F = average factor

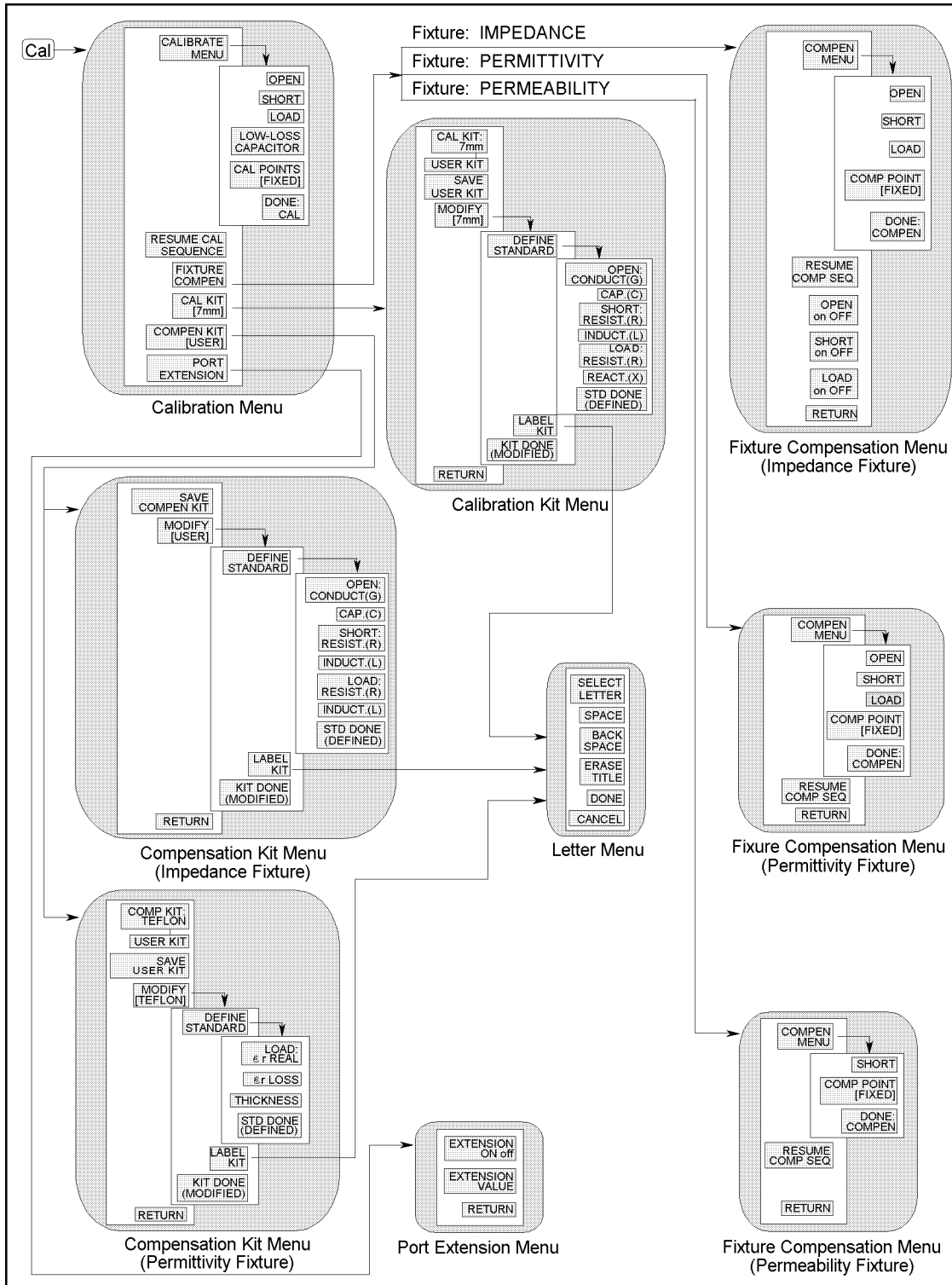

CE005014

Figure 5-41. Softkey Menu Accessed from **Cal** key

Calibration Menu

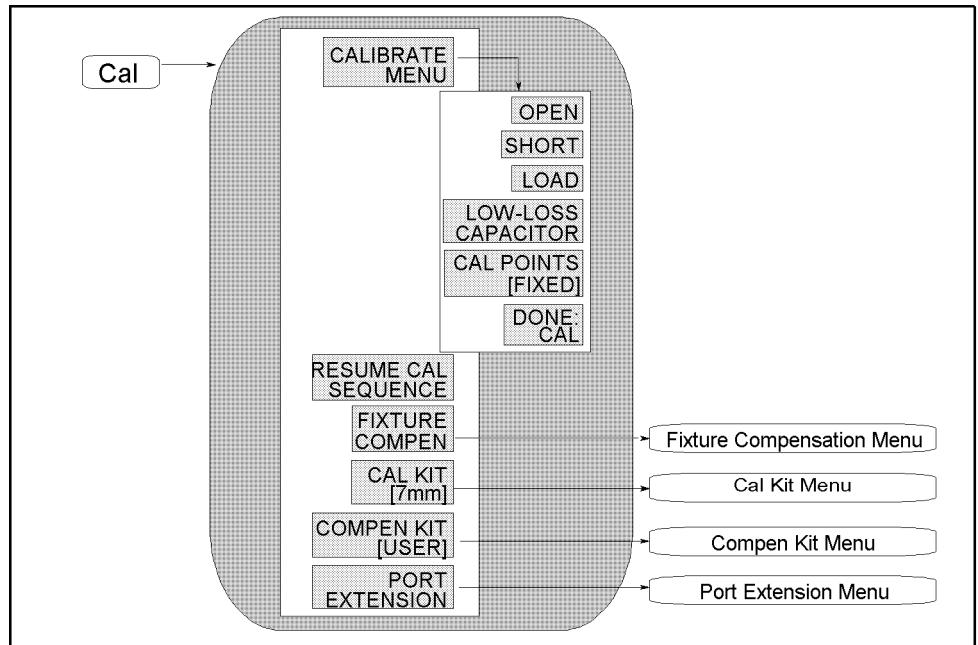

CE005027

Figure 5-42. Calibration Menu

- **CALIBRATE MENU** Leads to the following softkeys, which are used to perform a calibration measurement.
 - **OPEN** Measures OPEN standard of the cal kit for the calibration.
 - **SHORT** Measures SHORT standard of the cal kit for the calibration.
 - **LOAD** Measures LOAD standard of the cal kit for the calibration.
 - **LOW-LOSS CAPACITOR** Measures LOW-LOSS CAPACITOR standard of the cal kit for the calibration.
 - **CAL POINTS []** Toggles between FIXED and USER DEFINED, to select the calibration measurement points. When **[FIXED]** is displayed, the analyzer performs calibration measurements on points fixed across the full frequency sweep range, and the effective value for the points between these measured points will be calculated using the interpolation method. When **[USER]** is displayed, the analyzer performs calibration measurements on the same points as the current stimulus setting.

Note



For user defined calibration, set point averaging factor to 32.

- **DONE:CAL** Completes the calibration and then computes and stores the error coefficients. The notation COR (calibration on fixed cal point is ON) or Cor (calibration in user cal points is ON) is displayed on the left side of the screen.
- **RESUME CAL SEQUENCE** Eliminates the need to restart a calibration sequence that was interrupted to access some other menu. Goes back to the point where the calibration sequence was interrupted.

- **FIXTURE COMPEN** Displays the *Fixture Compensation menu*, which is used to perform the fixture compensation measurements in order to reduce measurement errors existing along the test fixture.
- **CAL KIT []** Leads to the *Cal Kit menu* that selects the default calibration kit and a user kit. This in turn displays additional softkeys used to define calibration standards other than those in the default kits. When a calibration kit has been specified, its label is displayed in brackets in the softkey label.
- **COMPEN KIT []** Leads to the *Compen Kit menu* that is used to define user-define OPEN, SHORT, and LOAD for fixture compensation measurements. When a set of user-defined OPEN, SHORT, and LOAD values has been specified, its label is displayed in brackets in the softkey label.
- **PORT EXTENSIONS** Leads to the *Port Extension menu*, which is used to extend the apparent location of the measurement reference plane.

FIXED Cal and Compensation Points							
When FIXED is selected for the calibration measurement points using CAL POINTS[] , the analyzer measures the standards on the following 178 frequency points. The analyzer also measures the OPEN, SHORT, and LOAD compensation measurement points for the fixture compensation at the same frequency points.							
(unit :MHz)							
1	1.03	1.06	1.09	1.12	1.15	1.18	1.21
1.24	1.26	1.29	1.32	1.35	1.38	1.41	1.44
1.47	1.5	1.55	1.6	1.65	1.7	1.75	1.8
1.85	1.9	1.95	2.0	2.1	2.2	2.3	2.4
2.5	2.6	2.8	3.0	3.2	3.4	3.6	3.8
4.0	4.3	4.6	5.0	5.5	6.0	6.5	7.0
7.5	8	9	10	11	12	13	14
15	16	18	20	22	24	26	28
30	33	36	39	42	45	48	51
55	60	65	70	75	80	85	90
95	100	110	120	130	140	150	160
170	180	190	200	220	240	260	280
300	320	340	360	380	400	420	440
460	480	500	520	540	560	580	600
620	640	660	680	700	720	740	760
780	800	820	840	860	880	900	920
940	960	980	1000	1020	1040	1060	1080
1100	1120	1140	1160	1180	1200	1220	1240
1260	1280	1300	1320	1340	1360	1380	1400
1420	1440	1460	1480	1500	1520	1540	1560
1580	1600	1620	1640	1660	1680	1700	1720
1740	1760	1780	1800				

FIXED Compensation Points require FIXED CAL Points
When the compensation measurements are performed at the FIXED points, the calibration measurements must have been performed at the FIXED Cal Points. If the calibration was performed at the USER points, the compensation measurements must be performed at the USER points.

Fixture Compensation Menu (for Impedance Measurement)

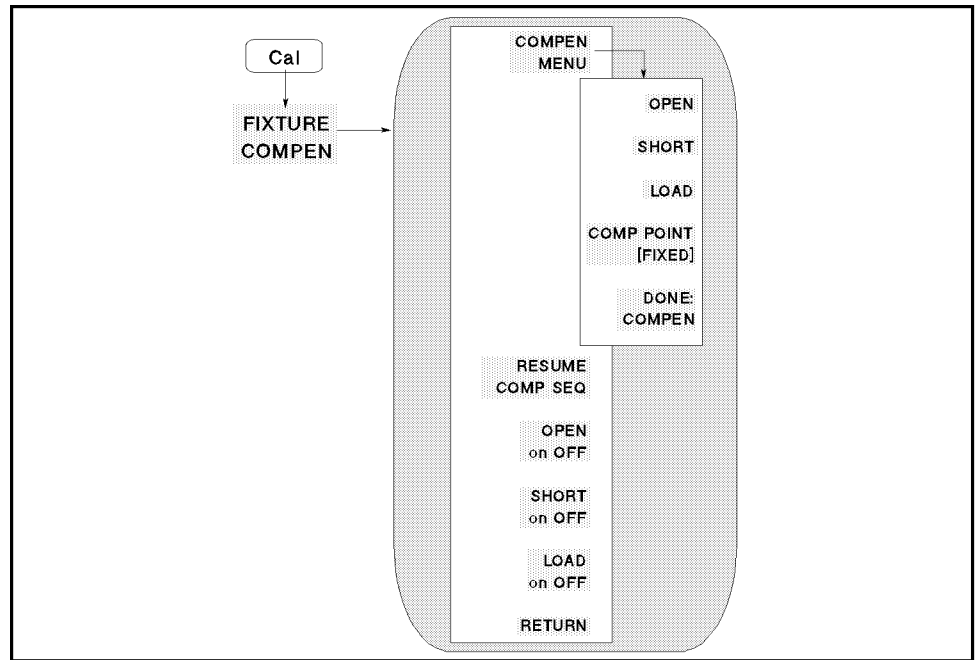
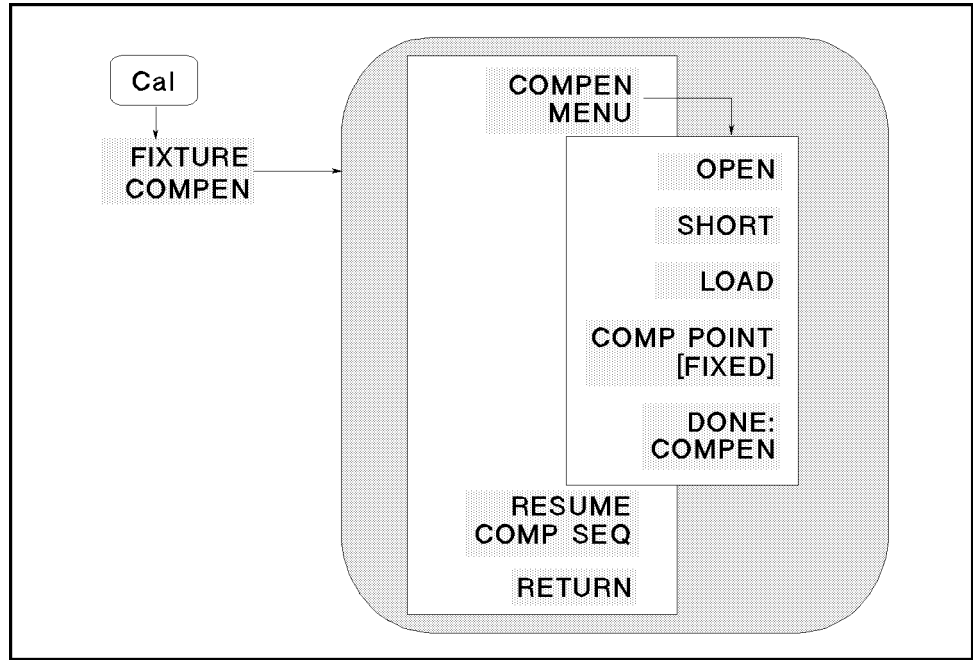

Figure 5-43. Fixture Compensation Menu

- **COMPEN MENU** Leads to the following softkeys, which are used to perform a fixture compensation measurement.
 - **OPEN** Measures OPEN for the fixture compensation.
 - **SHORT** Measures SHORT standard for the fixture compensation.
 - **LOAD** Measures LOAD standard for the fixture compensation.
 - **COMP POINT []** Toggles between FIXED and USER DEFINED, to select the fixture compensation measurement points. When [FIXED] is displayed, the analyzer performs fixture compensation measurements on points fixed across the full frequency sweep range, and the effective value for the points between these measured points will be calculated using the interpolation method. When [USER] is displayed, the analyzer performs fixture compensation measurements on the same points as the current stimulus setting.
 - **DONE:COMPEN** Completes the fixture compensation and then computes and stores the error coefficients.
- **RESUME COMP SEQ** Eliminates the need to restart a fixture compensation sequence that was interrupted to access some other menu. Goes back to the point where the fixture compensation sequence was interrupted.
- **OPEN ON off** Turns OPEN fixture compensation ON or OFF.
- **SHORT ON off** Turns SHORT fixture compensation ON or OFF.
- **LOAD ON off** Turns LOAD fixture compensation ON or OFF.

Fixture Compensation Menu (for Permittivity Measurement)



06005032

Figure 5-44.
Fixture Compensation Menu (for Permittivity Measurement)

This menu can be accessed when Option 002 is installed and the 16453A is selected as the fixture to be used.

- **COMPEN MENU** Leads to the following softkeys, which are used to perform a fixture compensation measurement.
 - **OPEN** Measures OPEN for the fixture compensation.
 - **SHORT** Measures SHORT for the fixture compensation.
 - **LOAD** Measures the standard device furnished with the 16453A for the fixture compensation.
 - **COMP POINT []** Toggles between FIXED and USER DEFINED, to select the fixture compensation measurement points.
 - When **[FIXED]** is displayed, the analyzer performs fixture compensation measurements on points fixed across the full sweep range, and the effective value for the points between these measured points will be calculated using the interpolation method. When **[USER]** is displayed, the analyzer performs fixture compensation measurements on the same points as the current stimulus setting.
 - **DONE:COMPEN** Completes the fixture compensation and then computes and stores the error coefficients.
- **RESUME COMP SEQ** Eliminates the need to restart a fixture compensation sequence that was interrupted to access some other menu. Goes back to the point where the fixture compensation sequence was interrupted.

Fixture Compensation Menu (for Permeability Measurement)

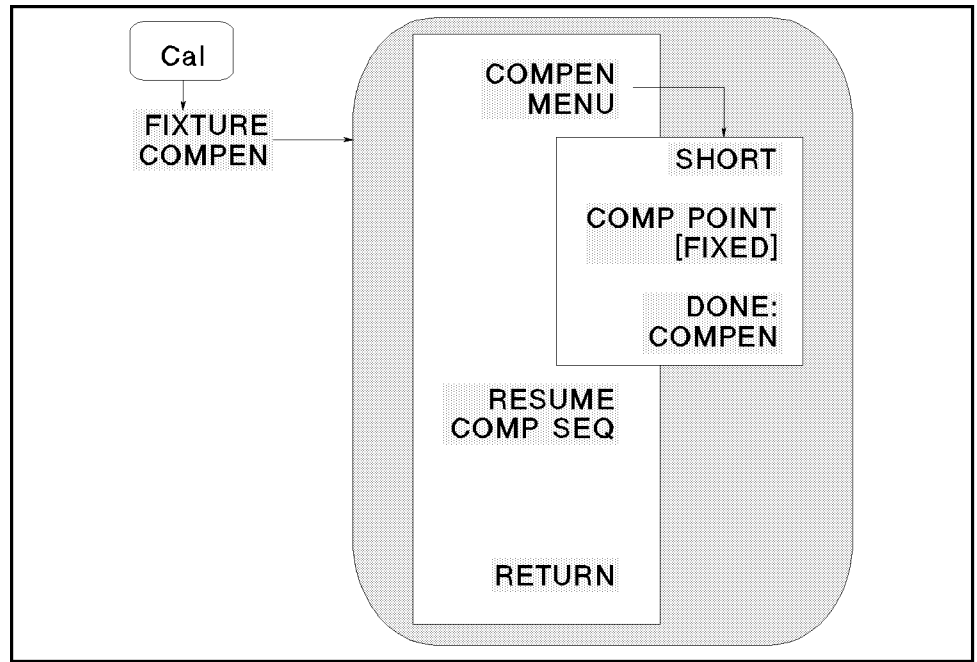

CV005033

Figure 5-45.
Fixture Compensation Menu (for Permeability Measurement)

This menu can be accessed when Option 002 is installed and 16454A is selected as fixture to be used.

- **COMPEN MENU** Leads to the following softkeys, which are used to perform a fixture compensation measurement.
 - **SHORT** Measures SHORT for the fixture compensation.
 - **COMP POINT []** Toggles between FIXED and USER DEFINED, to select the fixture compensation measurement points. When **[FIXED]** is displayed, the analyzer performs fixture compensation measurements on points fixed across the full sweep range, and the effective value for the points between these measured points will be calculated using the interpolation method. When **[USER]** is displayed, the analyzer performs fixture compensation measurements on the same points as the current stimulus setting.
 - **DONE:COMPEN** Completes the fixture compensation and then computes and stores the error coefficients.
- **RESUME COMP SEQ** Eliminates the need to restart a fixture compensation sequence that was interrupted to access some other menu. Goes back to the point where the fixture compensation sequence was interrupted.

Calkit Menu

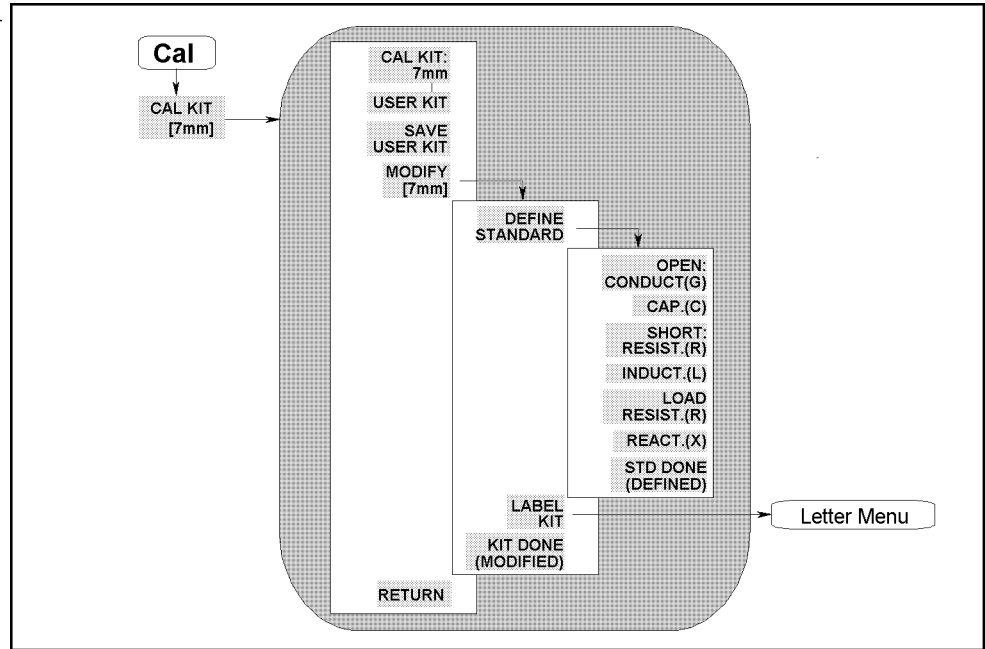

CE005028

Figure 5-46. Calkit Menu

- CAL KIT
- CAL KIT: 7 mm Selects the 7 mm cal kit (the furnished cal kit) model.
 - USER KIT Selects a cal kit model modified and stored into memory using SAVE USER KIT by the user.
 - SAVE USER KIT Stores the current cal kit into memory as USER KIT, after it has been modified.
 - MODIFY [] Displays the following softkeys, which are used to modify standard definitions.
 - DEFINE STANDARD Leads to the following softkeys, which are used to define the OPEN, SHORT and LOAD.
 - OPEN: CONDUCT(G) Makes conductance value (G) of OPEN the active function.
 - CAP. (C) Makes capacitance value (C) of OPEN the active function.
 - SHORT: RESIST. (R) Make resistance value (R) of SHORT the active function.
 - INDUCT. (L) Makes inductance value (L) of SHORT the active function.
 - LOAD: RESIST. (R) Make resistance value (R) of LOAD the active function.
 - REACT. (X) Make reactance value (X) of LOAD the active function.
 - STD DONE (DEFINED) Terminates the standard definition. press this after each standard is defined.
 - LABEL KIT Leads to the *Letter menu* to define a label for a new calibration kit. This label appears in the CAL KIT softkey label

in the *Calibration menu* and the **MODIFY** label in the *Cal Kit menu*. It is saved with the cal kit data.

- **KIT DONE (MODIFIED)** Completes the procedure to define a current cal kit.

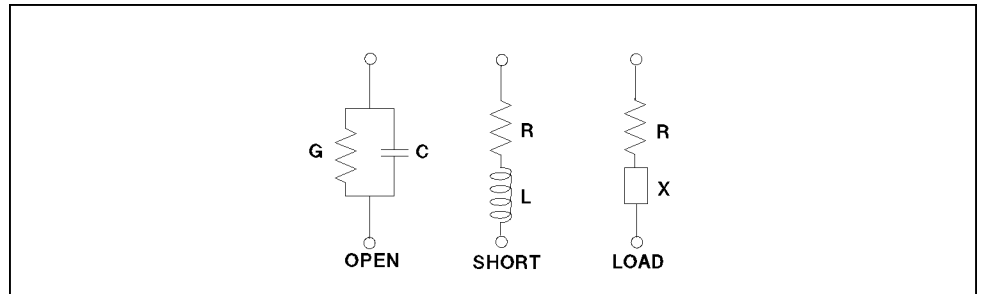
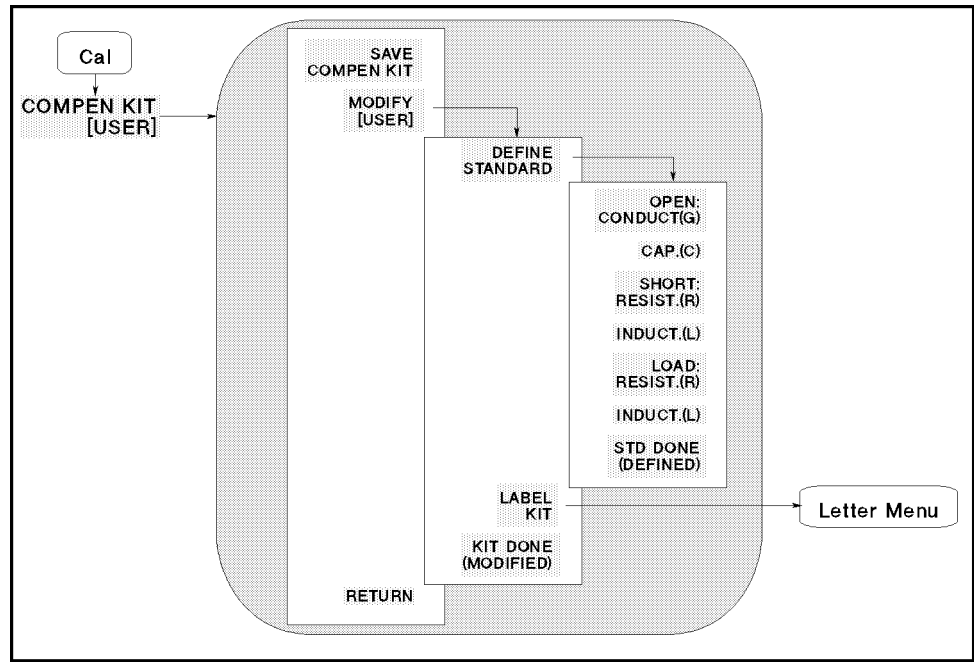

Figure 5-47. Calibration Standard Model

Compen Kit Menu (for Impedance Measurement Fixture)



06005034

Figure 5-48.
Compen Kit Menu (for Impedance Measurement Fixture)

- **SAVE COMPEN KIT** Stores the user-modified or user-defined OPEN, SHORT, and LOAD for fixture compensation into memory, after it has been modified.
- **MODIFY []** Leads to the following softkeys, which are used to modify a default definition of OPEN, SHORT, and LOAD for the fixture compensation.
 - **DEFINE STANDARD** Leads to the following softkeys, which are used to define the parameters of OPEN, SHORT, and LOAD for the fixture compensation.
 - **OPEN: CONDUCT(G)** Makes conductance value (G) of OPEN the active function.
 - **CAP.(C)** Makes capacitance value (C) of OPEN the active function.
 - **SHORT: RESIST.(R)** Makes resistance value (R) of SHORT the active function.
 - **INDUCT.(L)** Makes inductance value (L) of SHORT the active function.
 - **LOAD: RESIST.(R)** Makes resistance value (R) of LOAD the active function.
 - **INDUCT.(L)** Makes inductance value (L) of LOAD the active function.
 - **STD DONE (DEFINED)** Completes the procedure to define user-defined OPEN, SHORT, and LOAD.

- **LABEL KIT** Leads to the *Letter menu* to define a label for a new set of user-defined OPEN, SHORT, and LOAD. This label appears in the **COMPEN KIT** softkey label in the *Calibration menu* and the **MODIFY** label in the *Compen Kit menu*. It is saved with the data of OPEN, SHORT, and LOAD.
- **KIT DONE (MODIFIED)** Completes the procedure to define user-defined OPEN, SHORT, and LOAD for fixture compensation.

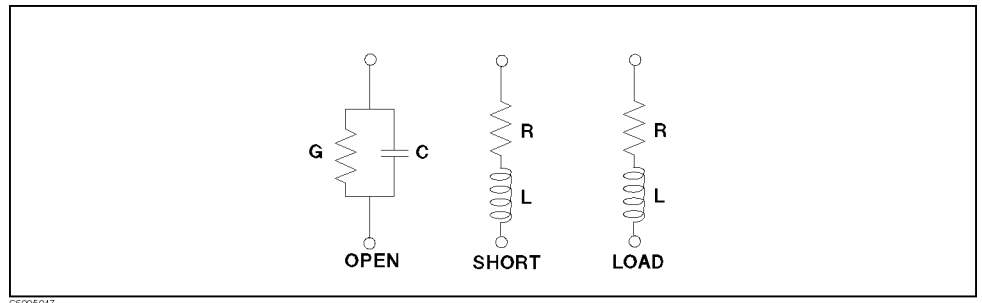

Figure 5-49.
**Parameters of OPEN, SHORT, and LOAD for the Impedance
Fixture Compensation**

Compen Kit Menu (for Permittivity Measurement Fixture)

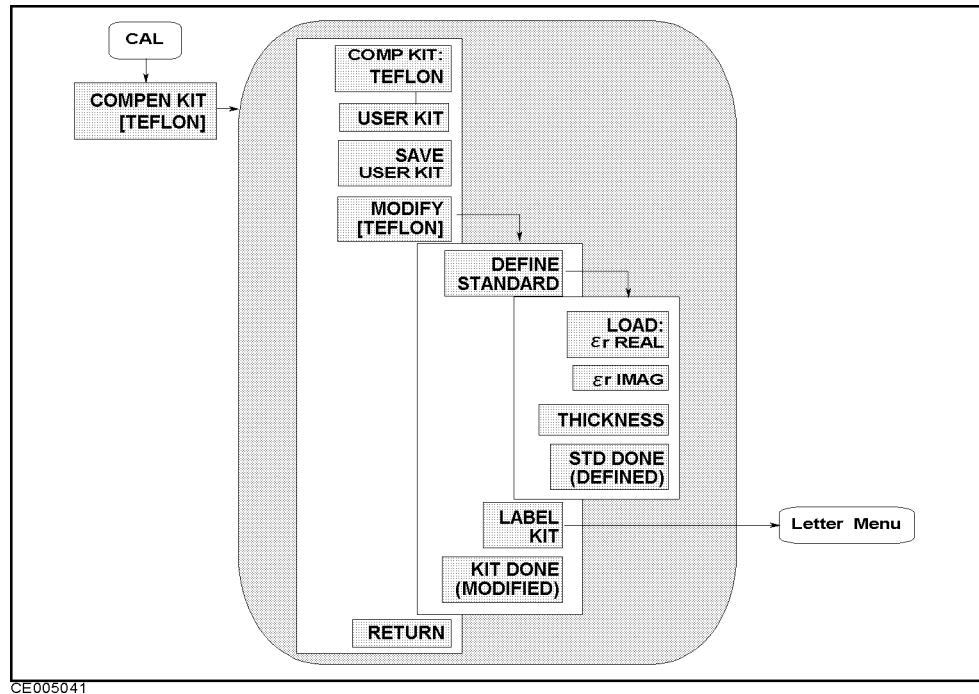

Figure 5-50.

Compen Kit Menu (for Permittivity Measurement Fixture)

This menu can be accessed when Option 002 is installed and the 16453A is selected as the test fixture to be used.

- **COMP KIT:TEFLON** Selects Teflon as the LOAD standard.
- **USER KIT** Selects a cal kit model defined or modified by the user using **SAVE COMPEN KIT** key.
- **SAVE COMPEN KIT** Stores the user-modified or user-defined OPEN, SHORT, and LOAD for fixture compensation into memory, after it has been modified.
- **MODIFY []** Leads to the following softkeys, which are used to modify a default definition of OPEN, SHORT, and LOAD for the fixture compensation.
 - **DEFINE STANDARD** Leads to the following softkeys, which are used to define the parameters of OPEN, SHORT, and LOAD for the fixture compensation.
 - **LOAD: ϵ_r REAL** Makes the effective relative permittivity of the LOAD standard the active function.
 - **ϵ_r LOSS** Makes the relative dielectric loss factor of the LOAD standard the active function.
 - **THICKNESS** Makes thickness of LOAD standard the active function.
 - **LABEL KIT** Leads to the *Letter menu* to define a label for a new set of user-defined OPEN, SHORT, and LOAD. This label appears in the **COMPEN KIT** softkey label in the *Calibration menu* and

the **MODIFY** label in the *Compen Kit menu*. It is saved with the calibration data.

- **KIT DONE (MODIFIED)** Completes the procedure to define user-defined OPEN, SHORT, and LOAD for fixture compensation.

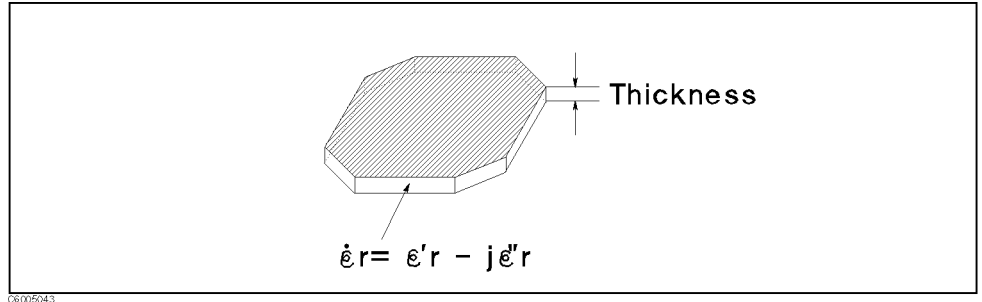
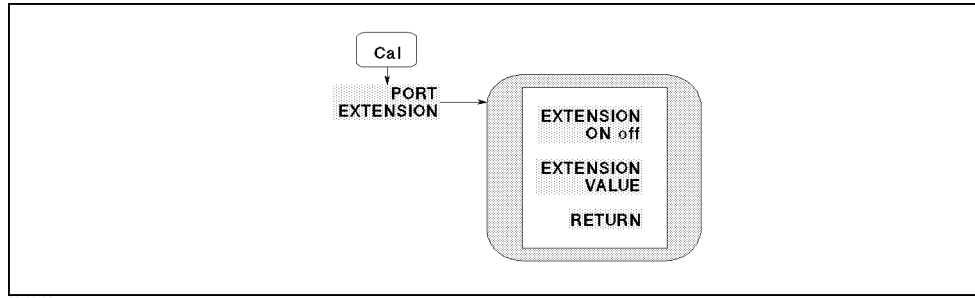

Figure 5-51.
Parameters of LOAD for the Permittivity Fixture Compensation

Port Extension Menu



06005035

Figure 5-52. Port Extension Menu

- **EXTENSIONS ON off** Turns port extension ON or OFF. When this function is ON, all extensions defined below it are enabled; when OFF, none of the extensions are enabled.
- **EXTENSION VALUE** Makes the port extension value the active function. Used to add electrical delay in seconds to extend the reference plane at the APC-7 connector on a test head to the end of the cable.

Note



For more information on the port extension, see “Port Extension” in Chapter 11

Stimulus Block

The stimulus block keys and associated menus provide control of the sweep, trigger, and source functions. The following list shows the functions controlled by each key in the stimulus block.

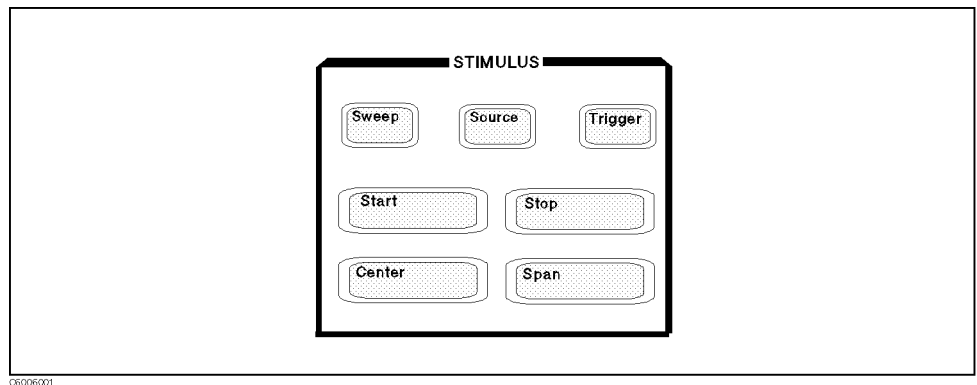
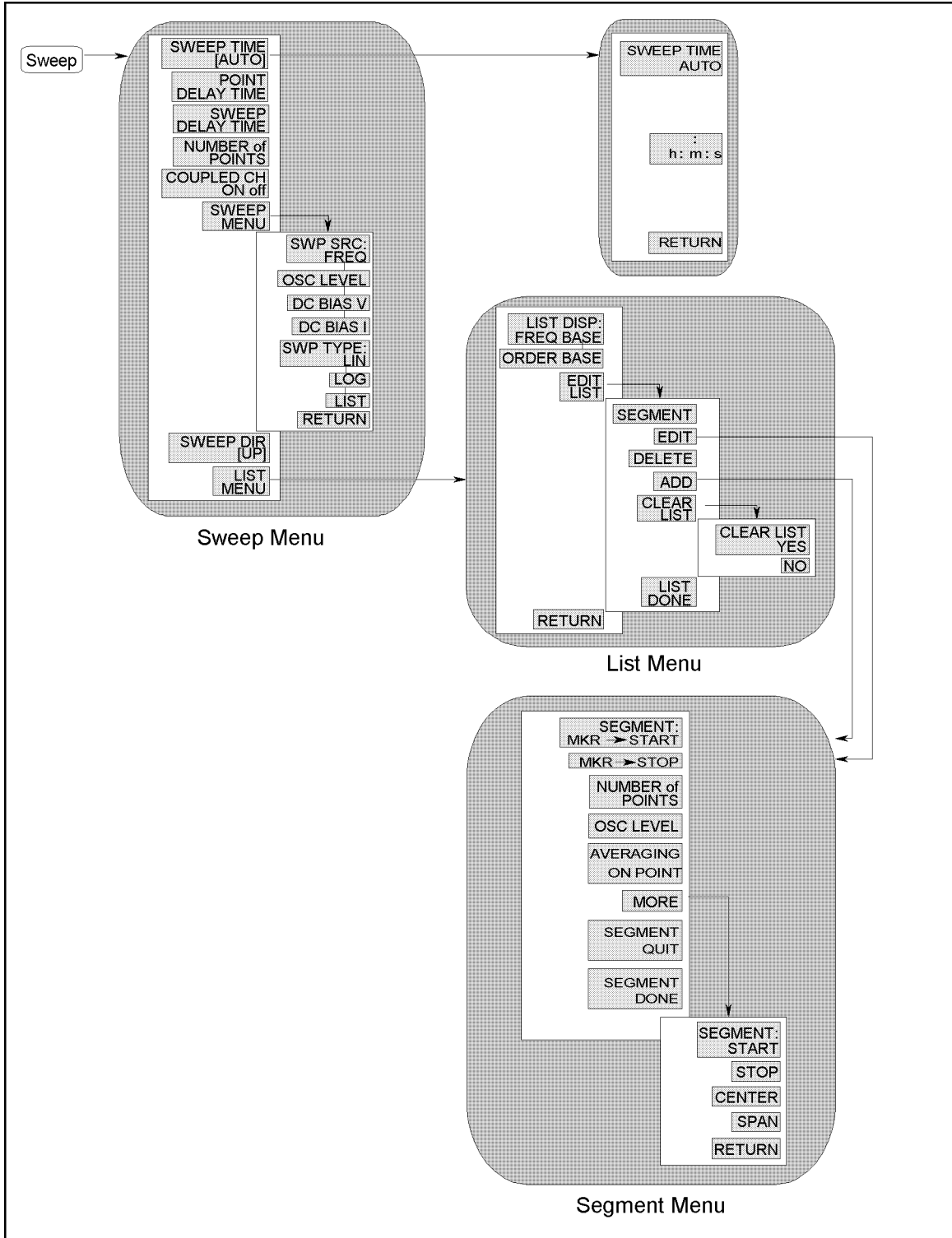

Figure 6-1. Stimulus Block

Sweep	Controlling delay time Specifying number of points to be measured Selecting sweep source Selecting sweep type and sweep direction Editing table for list sweep Selecting channel coupling
Source	Specifying output level of stimulus source Selecting OSC level unit Setting CW frequency for power sweep and dc bias sweep Controlling dc bias source
Trigger	Selecting trigger mode Selecting trigger source Selecting event caused by trigger Restarting measurement
Start	Setting start value of stimulus
Stop	Setting stop value of stimulus
Center	Setting center value of stimulus
Span	Setting span of stimulus

Functions accessed from this block	You can access from ...	See the following section in this chapter:
Channel Coupling	<input type="button" value="Sweep"/>	<i>Sweep Menu</i>
Continuous sweep	<input type="button" value="Trigger"/>	<i>Trigger menu</i>
DC bias sweep	<input type="button" value="Sweep"/>	<i>Sweep Menu</i>
DC bias	<input type="button" value="Source"/>	<i>Source Menu</i>
Delay time (sweep delay, point delay)	<input type="button" value="Sweep"/>	<i>Sweep Menu</i>
External trigger	<input type="button" value="Trigger"/>	<i>Trigger menu</i>
Linear sweep	<input type="button" value="Sweep"/>	<i>Sweep Menu</i>
List sweep	<input type="button" value="Sweep"/>	<i>Sweep Menu</i>
List sweep table edit	<input type="button" value="Sweep"/>	<i>List Menu and Edit Segment Menu</i>
Log sweep	<input type="button" value="Sweep"/>	<i>Sweep Menu</i>
Manual trigger	<input type="button" value="Trigger"/>	<i>Trigger menu</i>
Measurement Restart	<input type="button" value="Trigger"/>	<i>Trigger menu</i>
Number of points	<input type="button" value="Sweep"/>	<i>Test Head Selection</i>
OCS level sweep	<input type="button" value="Sweep"/>	<i>Sweep Menu</i>
OSC level	<input type="button" value="Source"/>	<i>Source Menu</i>
Single sweep	<input type="button" value="Trigger"/>	<i>Trigger menu</i>
Stimulus sweep range	<input type="button" value="Start"/> <input type="button" value="Stop"/> <input type="button" value="Center"/> <input type="button" value="Span"/>	<input type="button" value="Start"/> <input type="button" value="Stop"/> <input type="button" value="Center"/> <input type="button" value="Span"/>
Sweep direction	<input type="button" value="Sweep"/>	<i>Sweep Menu</i>
Sweep hold	<input type="button" value="Trigger"/>	<i>Trigger menu</i>
Trigger signal polarity	<input type="button" value="Trigger"/>	<i>Trigger menu</i>
User-specified number of sweeps	<input type="button" value="Trigger"/>	<i>Trigger menu</i>

For Additional Information on ...	See ...
Preset values and Setting Range of each function setting value	Appendix B in this manual
All Softkey Trees	Appendix C in this manual
GPIB Command Reference	GPIB Command Reference in the <i>Programming Manual</i>
How to control the 4291B using an external controller or the HP Instrument BASIC capability through the GPIB.	<i>Programming Manual</i>



CE006010

Figure 6-2. Softkey Menus Accessed from the **Sweep** Key

Sweep Menu

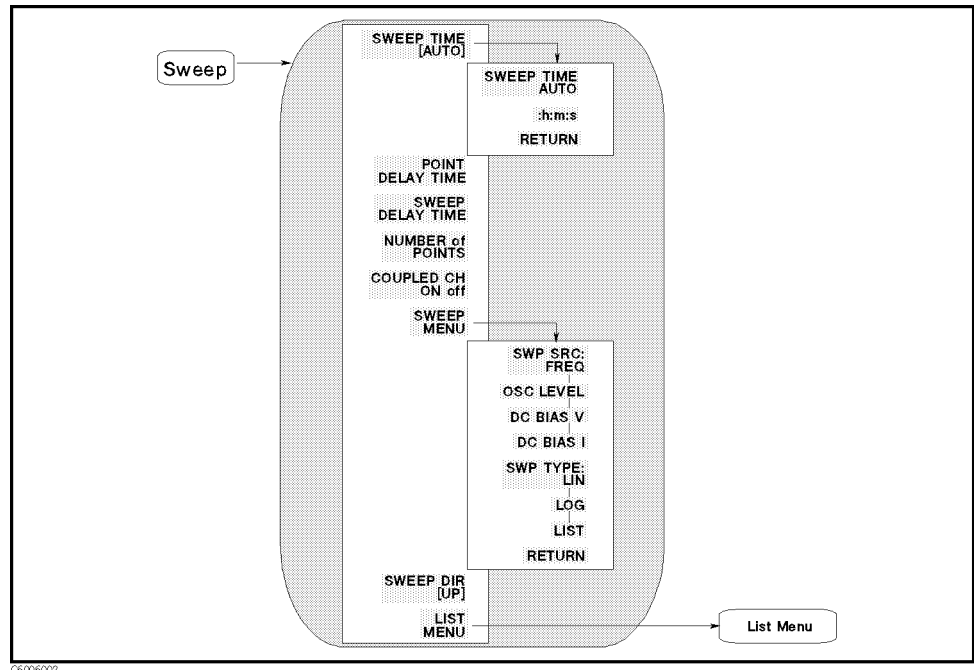

Figure 6-3. Sweep Menu

- **SWEEP TIME []** Makes sweep time the active function and leads to the following softkeys, which are used to specify sweep time and set automatic sweep time.
 - **SWEEP TIME AUTO** Selects the optimum (fastest) sweep time automatically. Pressing this softkey sets the point delay time to zero.
 - **:h:m:s** Makes manual time entry the active function. Enters “:” automatically.
- **POINT DELAY TIME** Makes point delay time the active function. When the point delay time is set, the analyzer delays the start of the measurement for the delay time specified at each measurement point. (See Figure 6-4.)
- **SWEEP DELAY TIME** Makes sweep delay time the active function. When the sweep delay time is set, the analyzer delays the start of the sweep for the delay time specified at each sweep. (See Figure 6-4.)
- **NUMBER of POINTS** Sets the number of data points per sweep. Using fewer points allows a faster sweep time but the displayed trace shows less horizontal detail. Using more points gives greater data density and improved trace resolution, but slows the sweep.

In list frequency sweep, the number of points displayed is the total number of frequency points for the defined list.
- **COUPLED CH ON off** Toggles channel coupling of the stimulus values. With **COUPLED CH ON** (the preset condition), both channels have the same stimulus values (the inactive channel takes on the stimulus values of the active channel). For information on the parameters that are coupled or uncoupled by the coupling function, see the table after Figure 6-4.

- **SWEEP MENU** Leads to the following softkeys, which are used to select sweep source and sweep type.
 - **SWP SRC:FREQ** Selects frequency sweep.
 - **OSC LEVEL** Selects OSC level sweep.
 - **DC-V** Selects dc bias voltage sweep (Option 001 only).
 - **DC-I** Selects dc bias current sweep (Option 001 only).
 - **SWEEP TYPE:LINEAR** Selects linear sweep.
 - **LOG** Selects Logarithmic sweep mode. The source is stepped in logarithmic increments and the data is displayed on a logarithmic graticule. If the sweep range includes zero, the sweep type is automatically changed to linear.
 - **LIST** Selects list frequency sweep. If a list is not defined, this softkey performs no function.
- **SWEEP DIR []** Toggles direction of sweep between up and down. When DOWN is selected, the analyzer sweep starts from the stimulus STOP value and sweeps to the START value. DOWN is only available for the OSC level, dc voltage, and dc current sweep. The down sweep is not available for frequency sweep.
- **LIST MENU** Leads to the *List menu*, which is used to control the list sweep and define the list sweep table.

Figure 6-4 shows the relationship between delay time and sweep time. The sweep delay time is not included in the sweep time. The summation of all point delay times is added to the sweep time. When both the sweep delay time and the point delay time are set, the analyzer starts the sweep after waiting for both of sweep delay time and point delay time.

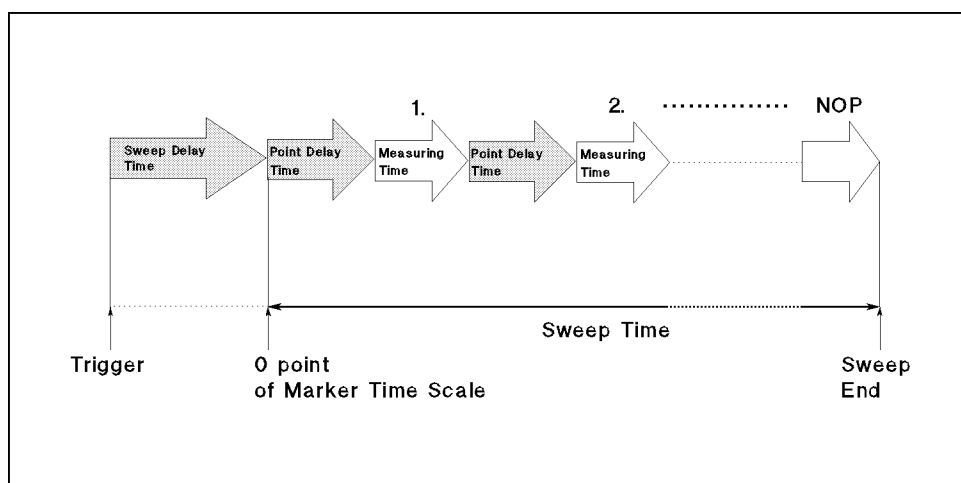
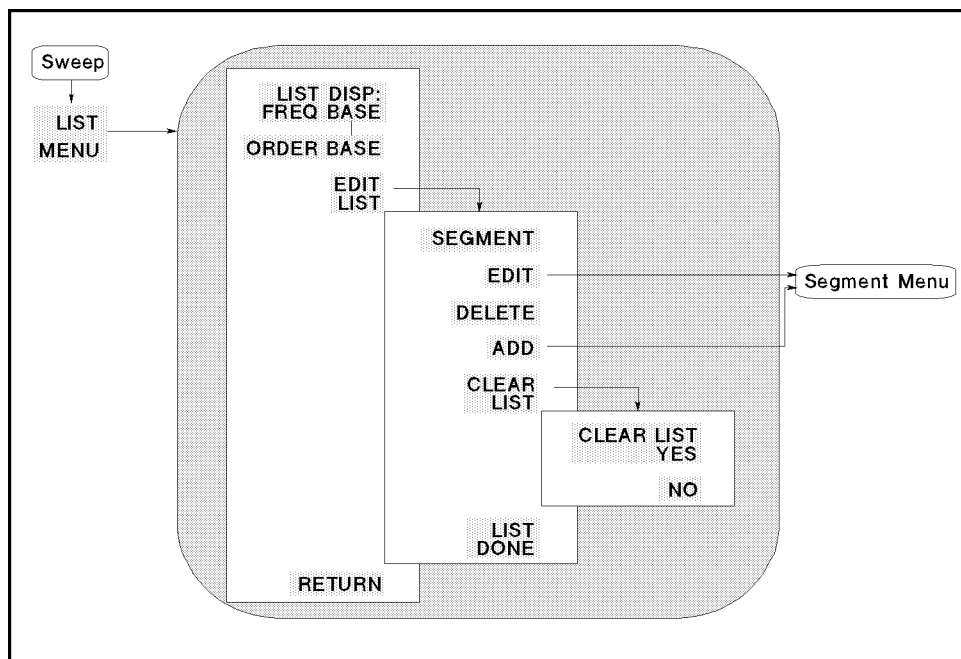

Figure 6-4. Sweep Delay Time and Point Delay Time

Parameters that are coupled or uncoupled by stimulus channel coupling		
If the stimulus is coupled, the following parameters are coupled:	The following parameters are always common to both channels, even if the stimulus is not coupled.	The following parameters are always set separately for each channel, even if the stimulus is coupled.
<ul style="list-style-type: none"> ■ Frequency ■ OSC Level ■ dc Bias ■ Delay Time ■ Sweep Source ■ Sweep Type ■ Sweep Direction ■ Number of Points ■ Trigger Mode ■ Correction/Compensation ■ Calibration Coefficients ■ Define Trace ■ Averaging (on/off, factor) ■ Limit Test (on/off) ■ OSC Level Unit 	<ul style="list-style-type: none"> ■ List Sweep Table ■ Trigger Source ■ Trigger Event ■ Port Extensions ■ Fixture Selection ■ Port Extension ■ Beep Off/Pass/Fail ■ Frequency Blank 	<ul style="list-style-type: none"> ■ Measurement Parameter ■ Format ■ Scale ■ Graticule (on/off) ■ Level Monitor ■ Limit Line

Use USER DEFINED calibration points for stable dc bias sweep measurements
<p>To get a stable dc bias sweep measurement result, use the user defined calibration point.</p> <ol style="list-style-type: none"> 1. Set NOP to 2 points. 2. Set START frequency to CW frequency. 3. Select USER DEF POINTS as the calibration points. 4. Perform OPEN, SHORT, and LOAD calibration measurements. 5. After calibration measurement, select dc bias sweep as the sweep mode and also you can change NOP or any other settings.

List Menu



C6006003

Figure 6-5. List Menu

- **LIST DISP:FREQ BASE** Displays data measured as frequency base in the frequency list mode. The frequency scale is linear across the total range. Because the frequency points may not distribute evenly across the graticule, the display resolution may be uneven. This causes the points to be more compressed in some parts of the trace than in other parts.
- **ORDER BASE** Displays data measured as order base in the frequency list mode. The displayed frequency resolution is even across the graticule, even though the frequency points are not distributed evenly. For more information, see the explanation of “Frequency Base and Order Base” on the next page.
- **EDIT LIST** Leads to the following softkeys, which are used to define or modify the frequency sweep list:
 - **SEGMENT** Determines a segment on the list to be modified. Enter the number of a segment in the list, or use the step keys to scroll the pointer “>” at the left to the required segment number. The indicated segment can then be edited or deleted.
 - **EDIT** Provides the *Segment menu*, which is used to define or modify the segment selected using **SEGMENT**. The segment indicated by the pointer “>” at the left can be modified.
 - **DELETE** Deletes the segment indicated by the pointer “>” at the left.
 - **ADD** Adds a new segment to be defined with the *Segment menu*. If the list is empty, a default segment is added and the *Segment menu* is displayed so it can be modified. If the list is not empty, the segment indicated by the pointer “>” is copied and the *Segment menu* is displayed.
 - **CLEAR LIST** Leads to the following softkeys, which are used to clear the list table.
 - **CLEAR LIST YES**
 - **NO**

- **CLEAR LIST YES** Clears the entire list.
- **NO** Cancels the task and softkeys and returns to the edit list menu.
- **LIST DONE** Defines the frequency sweep list and softkeys, and returns to the previous menu.

The stimulus range of a segment can not be overlapped with other segments.

The analyzer always sweeps from a lower frequency to a higher frequency (independent of the definition of the segments).

Frequency Base and Order Base

The result of a list sweep is displayed using one of the two display modes; *frequency base display mode* or *order base display mode*.

- **Frequency base:** The X-axis is linearly scaled by frequency. The analyzer automatically scales linearly from the sweep list. When the stimulus range of a segment is discontinuous from another segment, the segment traces are connected by a straight line.
- **Order base:** The X-axis is linearly scaled by the number of sweep points according to the sweep list.

The following figures show an example of the difference between these modes. This measurement has two segments, one is resonance frequency and another is anti-resonance frequency. The span of the lower segment is narrower than the span of the higher segment. If the trace of this list is displayed on the frequency base scale, the sweep points of interest cannot be displayed visibly (as shown in the left graph below). The order base can display this trace as shown in the right graph.

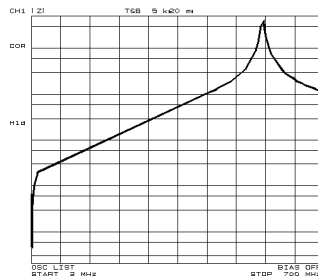

Frequency Base

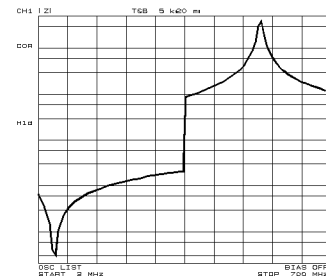

Order Base

Segment Menu

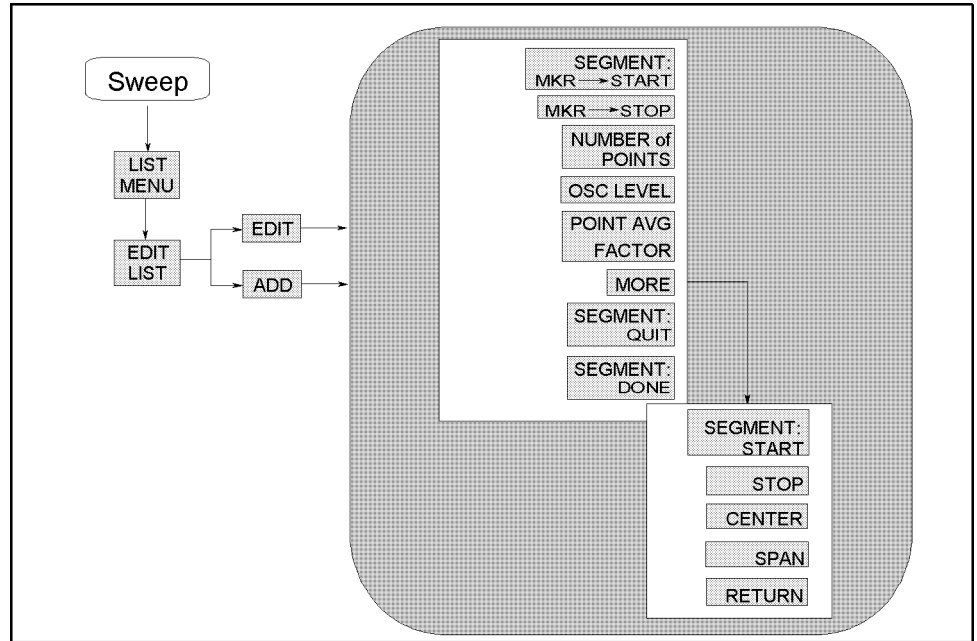

CE006004

Figure 6-6. Segment Menu

- **SEGMENT:MKR→START** Sets the stimulus start value to the stimulus value of the marker.
- **MKR→STOP** Sets the stimulus stop value to the stimulus value of the marker.
- **NUMBER of POINTS** Sets the number of points for the segment. The total number of points for all segments cannot exceed 801.
- **OSC LEVEL** Sets the OSC level segment by segment.
- **POINT AVG FACTOR** Sets the averaging factor of the averaging on point for the segment.
- **MORE** Leads to the following softkeys:
 - **SEGMENT:START** Sets the *START* frequency of a segment.
 - **STOP** Sets the *STOP* frequency of a segment.
 - **CENTER** Sets the *CENTER* frequency of a segment.
 - **SPAN** Sets the frequency *SPAN* of a segment about a specified center frequency.
- **SEGMENT QUIT** Returns to the previous softkey menu without saving the modified segment.
- **SEGMENT DONE** Saves the modified segment and returns to the previous softkey menu.

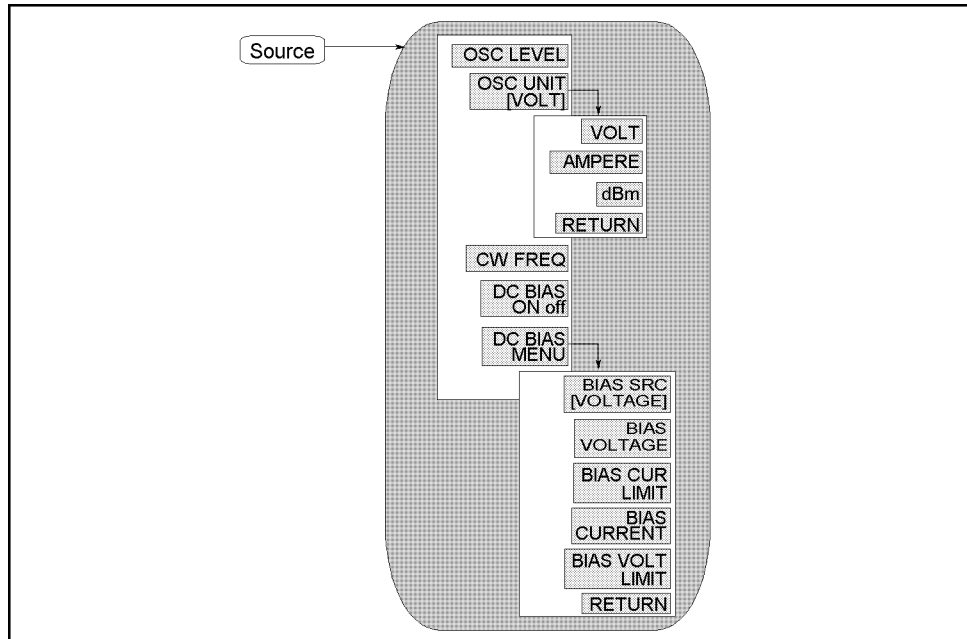

CE006005

Figure 6-7. Softkey Menus Accessed from the **Source Key**

Source Menu

- **OSC LEVEL** Makes OSC level the active function.
- **OSC UNIT []** Leads to the following softkeys, which are used to select the OSC level unit. The OSC level unit is displayed in brackets in the softkey label.
 - **VOLTAGE** Selects voltage as the OSC level unit.
 - **AMPERE** Selects ampere as the OSC level unit.
 - **dBm** Selects dBm as the OSC level unit.
- **CW FREQ** Sets the frequency for the OSC level sweep and DC bias sweep.
- **DC BIAS on OFF** Turn dc bias ON or OFF.
- **DC BIAS MENU** Leads to the following softkeys, which are used to specify level, unit, and voltage or current limit of dc bias.
 - **SOURCE []** Toggles the dc bias mode between the voltage setting (current compliance) mode and the current setting (voltage compliance) mode. The dc bias setting mode (VOLT or CURRENT) is displayed in brackets in the softkey label.
 - **BIAS VOLTAGE** Sets voltage of dc bias for voltage setting mode.
 - **BIAS CUR LIMIT** Sets current limit value of dc bias for voltage setting mode.
 - **BIAS CURRENT** Sets current value of dc bias for current setting mode.
 - **BIAS VOLT LIMIT** Sets voltage limit value of dc bias for current setting mode.

Note

The dc bias setting is common to both channels. In other words, you cannot turn on or off the dc bias of either channel 1 or 2.

The dc bias is automatically turned off when the calibration or fixture compensation measurement is done.

Marker Level Monitor Function

The analyzer can monitor the OSC level output and dc bias level applied to the DUT at each stimulus point using the marker. The softkey for the marker level monitor can be accessed from the **Utility** key in the MARKER block. See "**Utility**" in Chapter 7.

Source level value entered is not equal to the value applied to the DUT

For example, the OSC level voltage value displayed (or entered) is twice the value when terminating with 50Ω . (In other words, the OSC level displayed is approximately equal to the value when the terminal is open.) When the DUT is connected to the test terminal, the voltage dropped by the DUT's impedance causes the voltage value applied the DUT to be less than the OSC level setting.

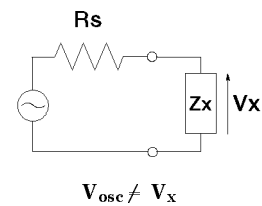
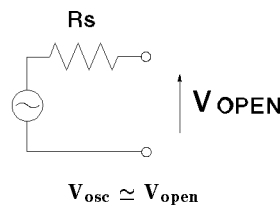
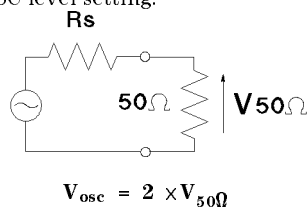

Definition of the OSC Level

The definitions of the OSC level are as follows:

- OSC voltage level (V_{osc}): V_{osc} is twice as large as the voltage value when terminating with 50Ω (approximately same as open voltage).
- OSC current level (I_{osc}): I_{osc} is twice as large as the current value when terminating with 50Ω (approximately same as short current).
- OSC power level (P_{osc}): P_{osc} is as the same as the power level when terminating with 50Ω

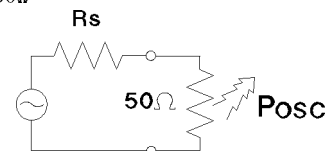
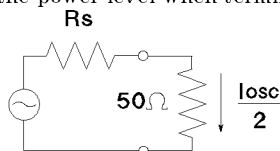
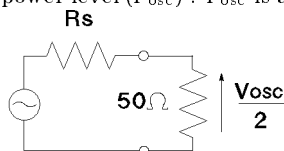

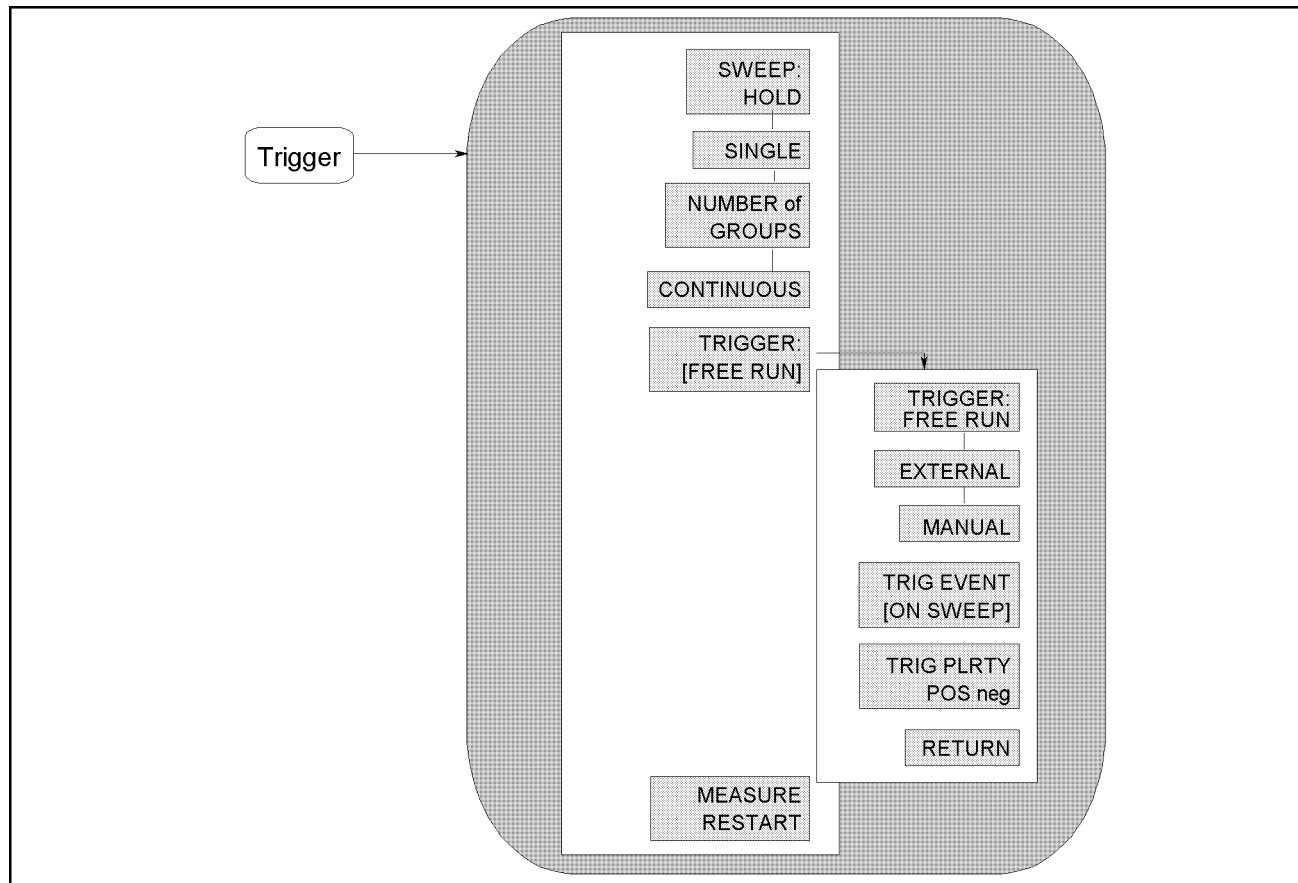

CE006006

Figure 6-8. Softkey Menus Accessed from the **Trigger** Key

Trigger Menu

- **SWEEP:HOLD** Freezes the data trace on the display and the analyzer stops sweeping and taking data. The notation “Hld” is displayed at the left of the graticule. If the “*” indicator is on (at the left side of the display), trigger a new sweep by pressing **SINGLE**.
- **SINGLE** Makes one sweep of the data and returns to the hold mode.
- **NUMBER of GROUPS** Selects the group sweep and makes the number of groups the active function. After the number of groups is entered and the analyzer is triggered, the analyzer sweeps a user-specified number and returns to the hold mode. If averaging on sweep is ON, set the number of groups at least equal to the selected averaging factor to allow the measurement of a fully averaged trace. Entering the number of groups resets the averaging counter to 1.
- **CONTINUOUS** Selects the continuous mode. In this mode the analyzer sweeps automatically and continuously (the trace is updated with each sweep).
- **TRIGGER: []** Displays the following softkeys, which are used to select the trigger source and to select trigger event mode. The trigger source is common to both channels.

The BUS trigger source can only be selected by using the GPIB command.

- **FREE RUN** Selects the internal trigger.
- **EXTERNAL** Selects the external trigger input from the EXT TRIGGER input BNC on the rear panel.
- **MANUAL** Selects the manual trigger and triggers a sweep.
- **TRIG EVENT []** Toggles the trigger event mode.

[ON POINT] The analyzer triggers on each data point in a sweep.

[ON SWEEP] The analyzer triggers a sweep.

- **TRIG PLRTY POS neg** Selects the trigger signal polarity of an externally generated signal connected to the rear panel EXT TRIGGER input.

POS neg The sweep is started by a low-to-high transition of a TTL signal.

pos NEG The sweep is started by a high-to-low transition of a TTL signal.

- **MEASURE RESTART** Aborts the sweep in progress and then restarts the measurement. This can be used to update a measurement following an adjustment of the DUT or test signal source.

- If the analyzer is measuring a number of groups, the sweep counter is reset to 1.
- If averaging on sweep is on, **MEASURE RESTART** resets the sweep-to-sweep averaging and is effectively the same as **AVERAGING RESTART**.
- If the sweep trigger is in the **HOLD** mode, **MEASURE RESTART** executes a single sweep.
- If **DUAL CHAN** is on (screen displays both measurement channels), **MEASURE RESTART** executes a single sweep of both channels even if **COUPLED CH** is off.

Start Stop Center Span

Start Stop Center Span

These keys define the start value, the stop value, the center value and the span value of the frequency range, OSC level range, or dc bias range of the stimulus. When one of these keys is pressed, its function becomes the active function. The value is displayed in the active entry area and can be changed with the knob, step keys, or numeric keypad. Current stimulus values for the active channel are also displayed along the bottom of the graticule.

The range can be expressed as either start/stop or center/span.

Marker Block

The marker block keys and associated menus provide control of the marker function. The following list shows the functions controlled by each key in the marker block.

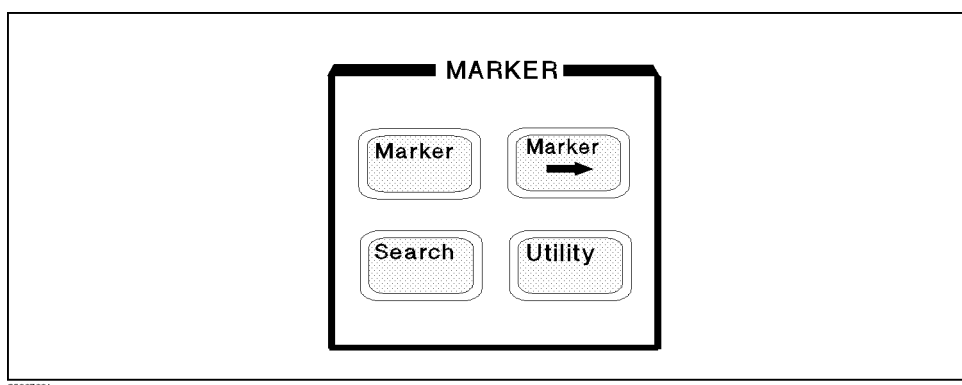



















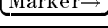

Figure 7-1. Marker Block

	Controlling the marker, sub-markers, and delta-marker Coupling markers on both channels
	Changing stimulus value and amplitude values to the current marker's value Zooming traces
	Searching for peak, maximum, minimum, or point specified by amplitude value Setting peak definition
	Listing marker values Calculating statistics value Displaying marker time Selecting marker form for Smith, polar, and admittance chart

Functions accessed from this block	You can access from ...	See the following section in this chapter:
Δmarker		<i>Marker Menu</i>
Coupling marker		<i>Marker Menu</i>
Level monitor		<i>Utility menu</i>
Marker, Sub-marker		<i>Marker Menu</i>
Marker list		<i>Utility menu</i>
Marker time		<i>Utility menu</i>
Marker→ function		<i>Marker→ menu</i>
Mean value		<i>Utility menu</i>
Partial search		<i>Search range menu</i>
Peak definition		<i>Peak definition menu</i>
Peak search, MAX/MIN search and target search		<i>Search menu</i>
Peak-to-peak		<i>Utility menu</i>
Relaxation time		<i>Utility menu</i>
Smith/polar maker ($\Gamma_x - \Gamma_y$, $ \Gamma - \theta$, $R + jX$, $G + jB$)		<i>Utility menu</i>
Standard deviation		<i>Utility menu</i>
Zooming traces		<i>Marker→ menu</i>

For Additional Information on ...	See ...
Preset values and Setting Range of each function setting value	Appendix B in this manual
All Softkey Trees	Appendix C in this manual
GPIB Command Reference	GPIB Command Reference in the <i>Programming Manual</i>
How to control the 4291B using an external controller or the HP Instrument BASIC capability through the GPIB.	<i>Programming Manual</i>

Note



The marker function is summarized in the last section of this chapter.

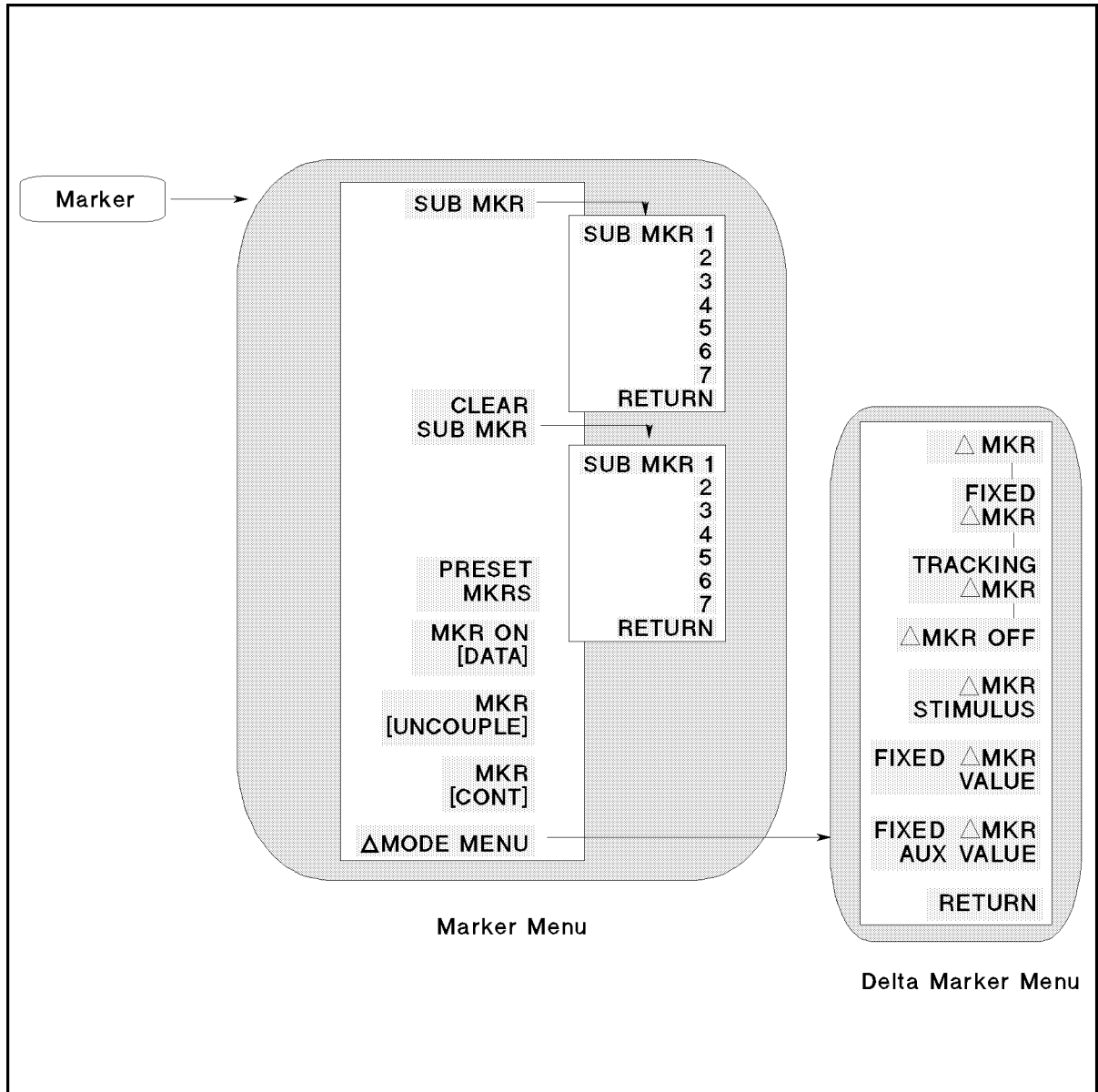

C6007002

Figure 7-2. Softkey Menus Accessed from the Marker Key

Marker Menu

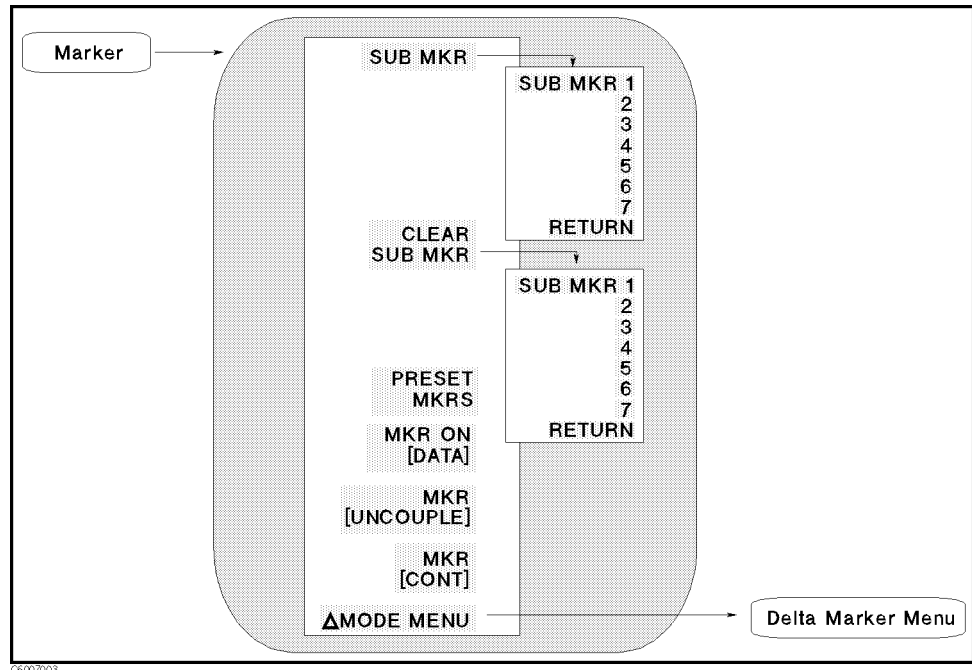

Figure 7-3. Marker Menu

- **SUB MKR** Displays the following softkeys, which are used to turn on sub-markers.
 - **SUB MKR 1, 2, 3, 4, 5, 6, 7** These keys put a sub-marker at the present marker position.
- **CLEAR SUB MKR** Displays the following softkeys, which are used to turn off sub-markers.
 - **SUB MKR 1, 2, 3, 4, 5, 6, 7** These keys turn a sub-marker OFF.
- **PRESET MKRS** Turns off all markers and cancels all settings of the marker functions.
- **MKR ON []** Selects a trace from data or memory to be applied for the marker values. This softkey does not appear if the user trace display is turned on.

[DATA] Shows that the data trace is selected.

[MEMORY] Shows that the memory trace is selected.

- **MKR [COUPLE] MKR [UNCOUPLE]** Toggles between the coupled and uncoupled marker mode. This softkey does not appear if the user trace display is turned on.

MKR [COUPLE] Couples the marker stimulus values for the two display channels. Even if the stimulus is uncoupled and two sets of stimulus values are shown, the markers track the same stimulus values on each channel as long as they are within the displayed stimulus range.

MKR [UNCOUPLE] Allows the marker stimulus values to be controlled independently on each channel.

- **MKR [DISCRETE] MKR [CONT]** Toggles between the continuous and discontinuous marker mode.

MKR [DISCRETE] Places markers only on the measured trace points as determined by the stimulus settings.

MKR [CONT] Interpolates between the measured points to allow the markers to be placed at any point on the trace. Displayed marker values are also interpolated. This is the default marker mode

- **ΔMODE MENU** Displays the *Delta Mode menu* that is used to define the difference in values between the marker and a Δ marker.

Delta mode menu

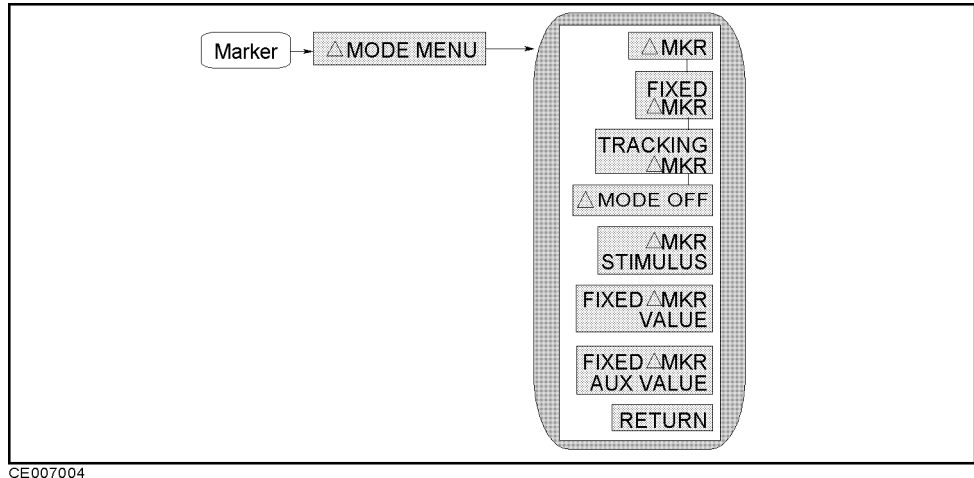

CE007004

Figure 7-4. Delta Mode Menu

- **Δ MKR** Puts the delta-marker on the current position of the marker.
- **FIXED Δ MKR** Sets a user-specified fixed reference marker. The stimulus and amplitude values can be set arbitrarily and can be anywhere in the display area. Unlike other markers, the fixed Δmarker need not be on the trace. The fixed Δmarker is indicated by a small triangle Δ, and the marker stimulus and measurement values are shown relative to this point. The notation ΔMkr is displayed at the top right corner of the graticule.
- **TRACKING Δ MKR** Makes the active marker a Δmarker (Tracking Δmarker). When this softkey is pressed a Δmarker moves to the active marker position. Then the Δmarker moves with the active marker. It looks as if the Δmarker tracks the active marker. In other words, the tracking Δmarker can be moved using the knob or a marker search function such as **SEARCH: PEAK**.
- **ΔMODE OFF** Turns off the delta marker mode. Therefore, the values displayed for the marker and sub-marker are now absolute values.
- **Δ MKR STIMULUS** Changes the stimulus value of the fixed Δmarker. Fixed Δmarker stimulus values can be different for the two channels if the channel markers are uncoupled.
- **FIXED Δ MKR VALUE** Changes the amplitude value of the fixed Δmarker. In a Cartesian format, this is the y-axis value. In a polar, Smith chart, admittance chart, or complex plane format, this is the first part (real part) of the complex data pair. It applies to a magnitude/phase marker, a real/imaginary marker, an R+jX marker, or a G+jB marker. Fixed Δmarker amplitude values are always uncoupled in the two channels.
- **FIXED Δ MKR AUX VALUE** Changes the auxiliary amplitude value of the fixed Δmarker (used only with a polar, Smith, admittance, or complex plane format). This is the second part (imaginary part) of a complex data pair. It applies to a magnitude/phase marker, a real/imaginary marker, an R+jX marker, or a G+jB marker. Fixed Δmarker auxiliary amplitude values are always uncoupled in the two channels. This softkey does not appear if the user trace display is turned on.

Marker→

The **Marker →** key activates the marker (if it is not already active) and provides access to the Marker→ functions. The Marker→ functions change the stimulus and amplitude values to make them equal to the current marker value. Use the knob or the numeric keypad to move the marker to the desired position on the trace and then press the appropriate softkey to set the specified parameters to that trace value. When the values are changed, the marker can again be moved within the range of the new parameters. The Marker→ functions can select either channel 1 or 2 as the destination channel whose value will be changed by the performing the Marker→ functions.

Marker→ menu

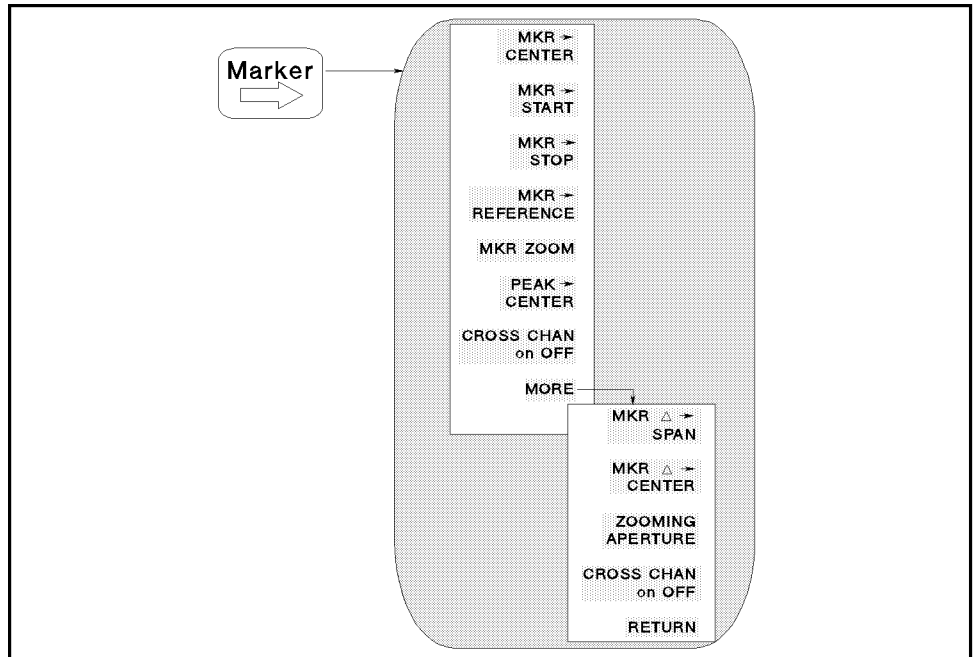

06007005

Figure 7-5. Marker→ Menu

- **MKR→CENTER** Changes the stimulus center value to the stimulus value of the marker and centers the new span about that value. When the cross channel (**CROSS CHAN**) is turned off, this softkey changes the center value of the active channel. When the cross channel is turned on, this softkey changes the parameter of the inactive channel.
- **MKR→START** Changes the stimulus start value to the stimulus value of the marker. When the cross channel (**CROSS CHAN**) is turned off, this softkey changes the start value of the active channel. When the cross channel is turned on, this softkey changes the parameter of the inactive channel.
- **MKR→STOP** Changes the stimulus stop value to the stimulus value of the marker. When the cross channel (**CROSS CHAN**) is turned off, this softkey changes the stop value of the active channel. When the cross channel is turned on, this softkey changes the parameter of the inactive channel.

- **MKR→REFERENCE** Sets the reference value to the marker's amplitude value. When the cross channel (**CROSS CHAN**) is turned off, this softkey changes the reference value of the active channel. When the cross channel is turned on, this softkey changes the parameter of the inactive channel.
- **MKR ZOOM** Changes the stimulus center value to the stimulus value of the marker and changes the stimulus span value to the value specified by the zooming aperture. When the cross channel (**CROSS CHAN**) is turned off, this softkey changes the parameters of the active channel. When the cross channel is turned on, this softkey changes the parameters of the inactive channel.
- **PEAK→CENTER** Moves the marker to the maximum or minimum peak and changes the stimulus center value to the stimulus value of the peak. When the cross channel (**CROSS CHAN**) is turned off, this softkey changes the center value of the active channel. When the cross channel is turned on, this softkey moves the marker to the peak of the active channel and changes the parameter of the inactive channel.
- **MKRΔ→SPAN** Changes the stimulus span value to the difference value between the marker and Δmarker values. When the cross channel (**CROSS CHAN**) is turned off, this softkey changes the span value of the active channel. When the cross channel is turned on, this softkey changes the parameter of the inactive channel.
- **MKRΔ→CENTER** Changes the stimulus center value to the difference value between the marker and Δmarker values. When the cross channel (**CROSS CHAN**) is turned off, this softkey changes the center value of the active channel. When the cross channel is turned on, this softkey changes the parameter of the inactive channel.
- **ZOOMING APERTURE** Sets the zooming aperture value as a percentage of the span.
- **CROSS CHAN on OFF** Selects the destination channel of the Marker→ functions. When the cross channel is turned off, a Marker→ function changes the stimulus or the amplitude value of the active channel. When the cross channel is turned on, a Marker→ function changes the parameters of the inactive channel.

CROSS CHAN ON off Selects the current inactive channel as the destination channel.

CROSS CHAN on OFF Selects the current active channel as the destination channel.

Turn off the channel coupling when the cross channel function is used

When you want to change one of channel 1 or 2 using marker → functions, turn off the channel coupling.

If the channel coupling (**COUPLED CHAN**) is on, a marker → functions always changes the settings of both channels.

The active channel is NOT changed to the destination channel after a Marker→ function is performed, even when the cross channel is turned on.

The cross channel can be turned on when the dual channel is turned on.

Search

Search

The **Search** key activates the marker (if it is not already active) and provides access to the marker search functions. The marker search functions can quickly search the trace for specified information.

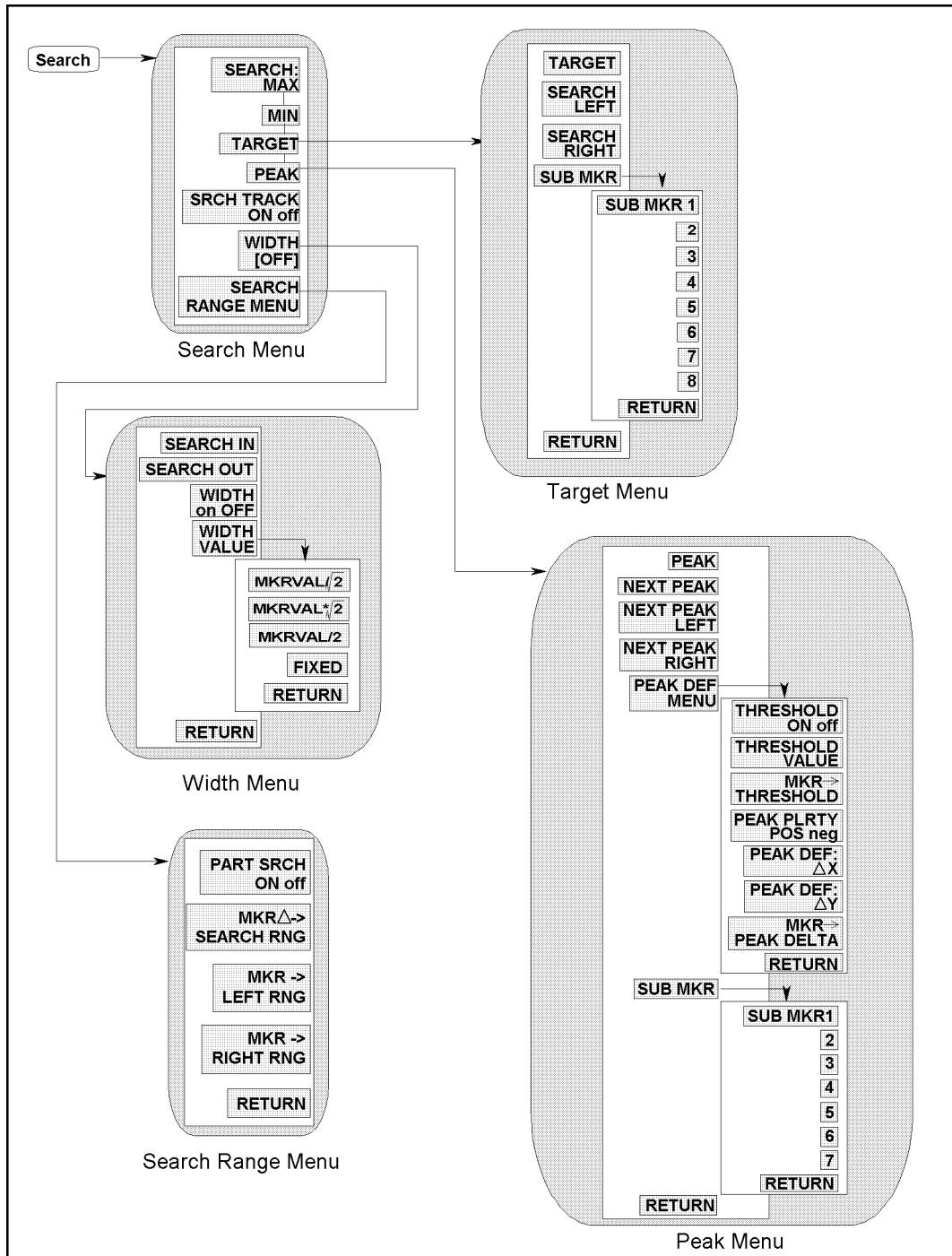

CE007006

Figure 7-6. Softkey Menus Accessed from the **Search** Key

Search Menu

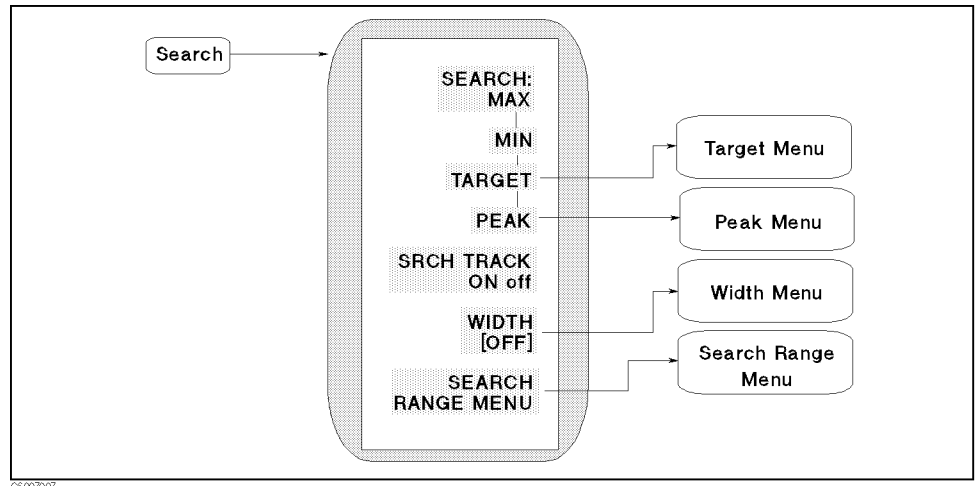

Figure 7-7. Search Menu

- **SEARCH:MAX** Moves the marker to the maximum amplitude point on the trace.
- **MIN** Moves the marker to the minimum amplitude point on the trace.
- **TARGET** Moves the marker to a specified target point on the trace and displays the *Target menu* that is used to search right or left to resolve multiple solutions.
- **PEAK** Moves the marker to the maximum or minimum peak and displays *Peak menu* that is used to search for the next peak. The search function searches for a peak that meets the peak definition specified in the *Peak Definition menu*. See the *Peak Definition menu* for more information on peak definition. This softkey does not appear if the user trace display is turned on.
- **SEARCH TRK ON off** Toggles the search tracking. This is used in conjunction with other search features (such as, sarch MAX, MIN, TARGET, and PEAK) to search each new sweep. This softkey does not appear if the user trace display is turned on.

SEARCH TRK ON off Directs the analyzer to search every new trace for the specified target value and puts the active marker on that point.

SEARCH TRK on OFF When the target is found on the current sweep, it remains at the same stimulus value regardless of changes in trace amplitude values in subsequent sweeps.

- **WIDTHS []** Displays the menu that is used to define the start and stop points for a width search and to turn width search ON and OFF. This softkey does not appear if the user trace display is turned on.

[OFF] Shows the width search is turned off.

[ON] Shows the width search is turned on.

- **SEARCH RANGE MENU** Displays the *Search Range menu*.

Target Menu

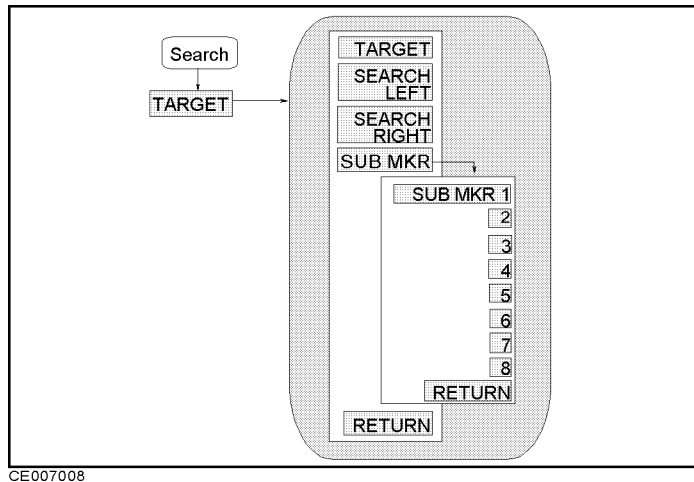

Figure 7-8. Target Menu

- **TARGET** Makes the target value the active function in which to enter a value and moves the marker to a specified target point on the trace.

The target value is in units appropriate to the current format.

In delta marker mode, the target value is the value relative to the Δ marker. If no Δ marker is ON, the target value is an absolute value.

- **SEARCH LEFT** Searches the trace for the next occurrence of the target value to the left.
- **SEARCH RIGHT** Searches the trace for the next occurrence of the target value to the right.
- **SUB MKR** Displays the following softkeys, which are used to put a sub-marker on the present marker position.
 - **SUB MKR 1, 2, 3, 4, 5, 6, 7** These keys put a sub-marker at the present marker position.

Peak Menu

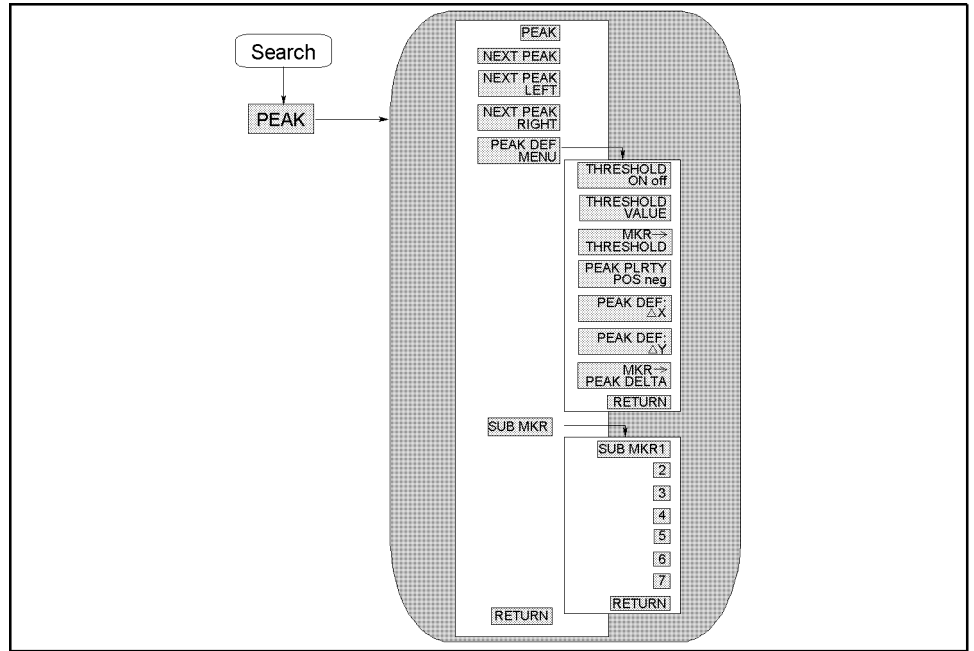

CE007009

Figure 7-9. Peak Menu

- **PEAK** Moves the marker to the maximum or minimum peak.
- **NEXT PEAK** Moves the marker to the next peak.
- **NEXT PEAK LEFT** Moves the marker to the peak on the left of the present marker position.
- **NEXT PEAK RIGHT** Moves the marker to the peak on the right of the present marker position.
- **PEAK DEF MENU** Displays the following softkeys, which are used to define peak to be searched.
 - **THRESHOLD ON OFF** Toggles the threshold on and off.
 - **THRESHOLD VALUE** Sets the threshold values.
 - **MKR→THRESHOLD** Changes the threshold value to the amplitude value of the present marker position.
 - **PEAK PLRTY POS neg** Selects the peak polarity for the marker search functions.

PEAK PLRTY POS neg	shows the positive peak is selected.
PEAK PLRTY pos NEG	shows the negative peak is selected.
 - **PEAK DELTA: ΔX** Sets the peak delta ΔX value that is used to define the peak.
 - **PEAK DELTA: ΔY** Sets the peak delta ΔY value that is used to define the peak.
 - **MKR→PEAK DELTA** Changes the peak delta value to the smaller value of the difference of amplitude values between the present maker position and both side display points of the marker.

Search Peak Function Definitions	
Peak polarity	Detects either the positive or negative peak that is defined by <code>PEAK PLRTY POS neg</code> .
Threshold	Detects a peak whose amplitude value is greater than or equal to the threshold (even if the peak polarity is negative). Threshold is used in order to reject the noise floor.
Peak Delta	Detects a peak whose differences of amplitude values between the peak and both side display points of the peak are greater than or equal to the peak delta value specified by <code>PEAK DELTA</code> . The peak delta function is used to reject small peaks.

- `SUB MKR` Displays the following softkeys, which are used to put a sub-marker on the present marker position.
 - `SUB MKR 1, 2, 3, 4, 5, 6, 7` These keys put a sub-marker at the present marker position.

Note



For more information on peak definition, see “Peak Definition” in the last part of this chapter.

Search Range Menu

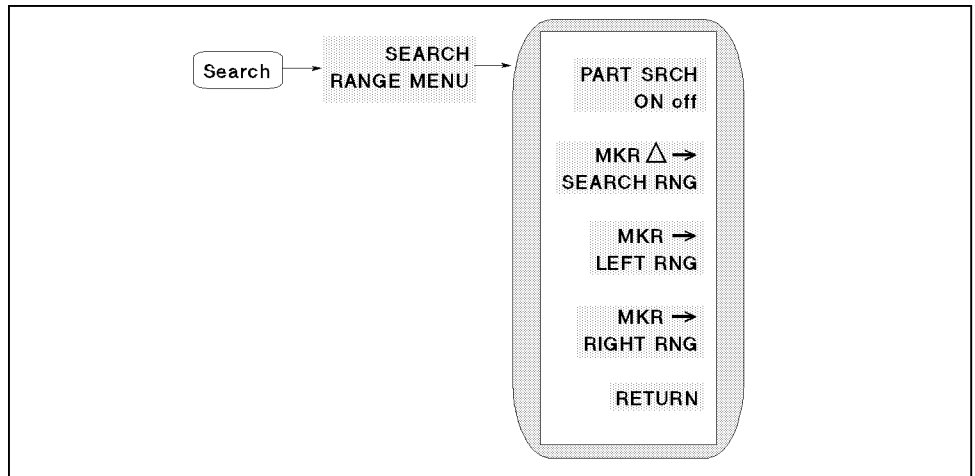

06007011

Figure 7-10. Search Range Menu

- **PART SRCH on OFF** Turns partial search ON or OFF. The search range is defined by two small triangles, “Δ”, at the bottom of the graticule. If no search range is defined, the search range is the entire trace.
- **MKRΔ→SEARCH RNG** Sets the partial search range to the range between the marker and Δmarker.
- **MKR→LEFT RNG** Sets the left (lower) border of the partial search range at the current position of the marker.
- **MKR→RIGHT RNG** Sets the right (higher) border of the partial search range at the current position of the marker.

Widths Menu

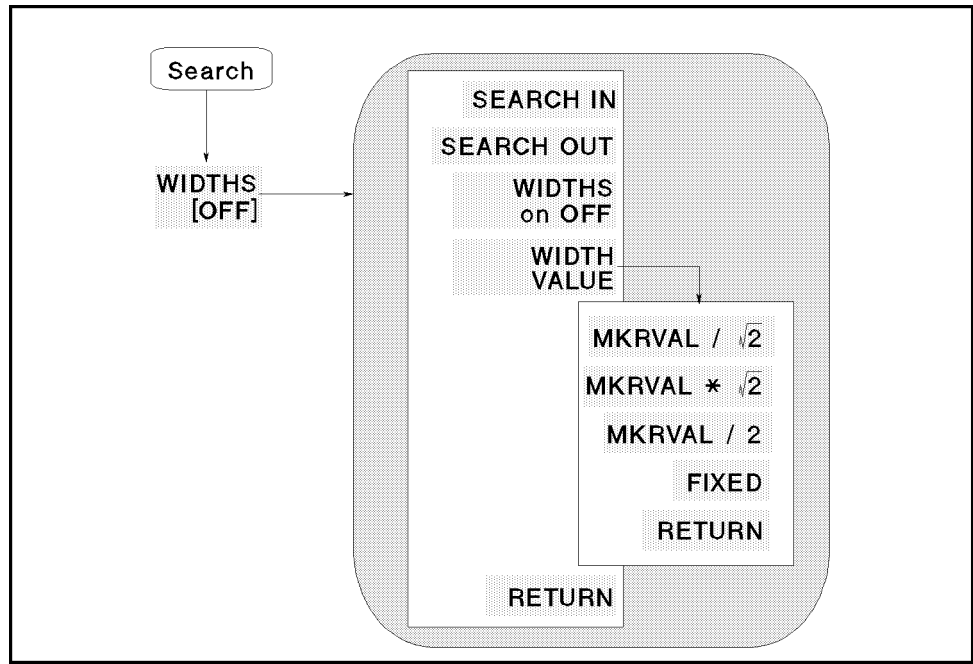

Figure 7-11. Widths Menu

- **SEARCH IN** Searches for the cutoff point on the trace that is within the current cutoff points.
- **SEARCH OUT** Searches for the cutoff point on the trace outside the current cutoff points.
- **WIDTHS on OFF** Turns on the width search feature and calculates the center frequency of a lobe on the trace, width, Q, and cutoff point deviation from the center stimulus value. The cut off point that defines the width parameters is set using the **WIDTH VALUE** softkey. For more information on the width parameters, see “Width Function” in the last part of this chapter.

The Δ marker is automatically changed to the tracking Δ marker when **WIDTHS** is turned on. When **WIDTHS** is ON, the (normal) Δ marker cannot be selected.

- **WIDTH VALUE** Sets a measurement value of a cutoff point that defines the start and stop points for a width search. The width search feature analyzes the center point and the width between the trace down from (or up to) the anti-resonance point or resonance point and the quality factor (Q) for the resonator. Width units are in the units of the current format.
 - **MKRVAL/($\sqrt{2}$)** Sets the width value to the value that equals the marker value divided by the square root of 2.
 - **MKRVAL*($\sqrt{2}$)** Sets the width value to the value that equals the marker value multiplied by the square root of 2.
 - **MKRVAL/2** Sets the width value to the value that equals the marker value divided by 2.
 - **FIXED VALUE** Makes the width value the active function and sets the width value to the value specified by this softkey.

In the expanded phase mode, this function searches for the two cutoff points whose values are “+WIDTH VALUE” and “-WIDTH VALUE.” For example, when the width value is 45° , the cutoff points' values are $\pm 45^\circ$.

Note



For more information on the width function, see “Width Function” in the last part of this chapter.

Utility Menu

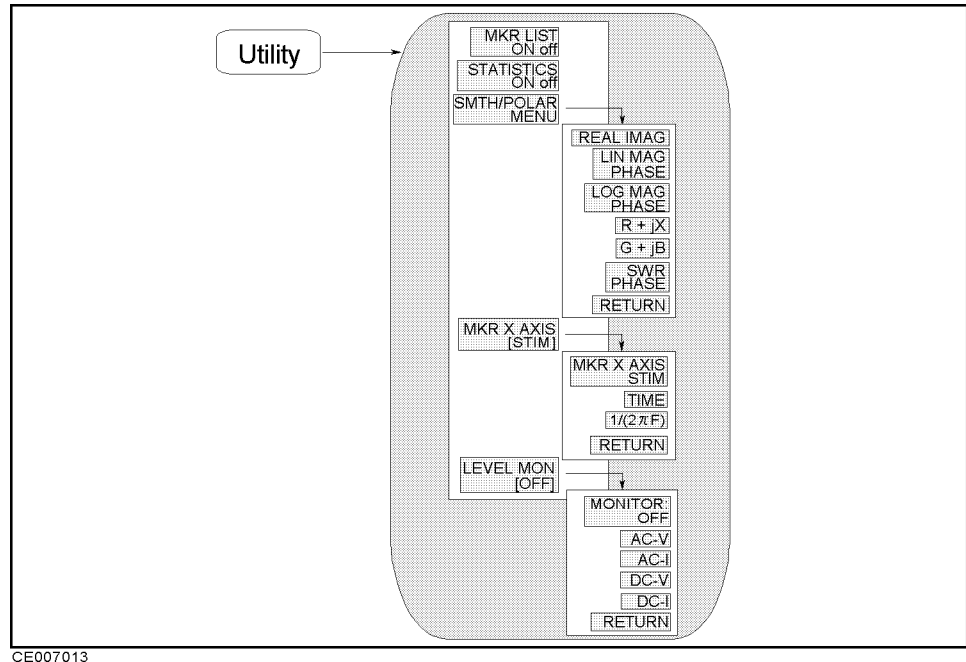

CE007013

Figure 7-12. Utility Menu

- **MKR LIST on OFF** Toggles the marker list function on and off. This lists the stimulus values and measurement values of all markers. In Δ mode, this also lists Δ marker.
- **STATISTICS on OFF** Calculates and displays the mean, standard deviation, and peak-to-peak values of the section of the displayed trace in the search range. If Partial Search is OFF, the statistics are calculated for the entire trace. The statistics are absolute values.

Statistics for Polar, Smith and Admittance Chart Formats

The statistics are calculated using the absolute value of the complex value.
--

A Convenient Use of Statistics

The statistics function provides a convenient way to find the peak-to-peak value without searching separately for the maximum and minimum values.

- **SMTH/POLAR MENU** Displays softkeys to select the form of the complex marker value on the Smith, polar, and admittance charts. This softkey does not appear if the user trace display is turned on.
 - **REAL IMAG** Displays the values of the marker on a Smith chart, an admittance chart, a polar chart, or a complex plane as a real and imaginary pair. The complex data is separated into its real and imaginary parts. The first marker value given is the real part ($= M \cos\theta$), and the second value is the imaginary part ($= M \sin\theta$), where M = magnitude.

- **LIN MAG PHASE** Displays a readout of the linear magnitude and the phase of the marker. Marker magnitude values are expressed in units of the current format and phase values in degrees.
- **LOG MAG PHASE** Displays the logarithmic magnitude value and the phase of the marker. Magnitude values are expressed in dB and phase values in degrees.
- **R+jX** Converts the marker values into rectangular form. The complex impedance values of the active marker are displayed in terms of resistance and reactance.
- **G+jB** Displays the complex admittance values of the marker in rectangular form. The marker values are displayed in terms of conductance and susceptance (in Siemens).
- **SWR PHASE** Displays the SWR value and phase value of the marker.

Do not use the SWR-Phase marker when the analyzer displays impedance or admittance parameters (SWR values have no meaning). Use SWR-PHASE with Γ measurements.

- **MKR X AXIS []** Leads the following softkeys to select X-axis value to be displayed. This softkey does not appear if the user trace display is turned on.
 - **MKR X AXIS STIM** Displays the marker stimulus value on the right upper corner of the screen. When the Δ mode is ON, this softkey shows a value relative to the Δ marker point.
 - **TIME** Sets the x-axis units to time, (the start point is zero and the stop point is the value of the sweep time). The marker indicates the elapsed time since the sweep started. This function is useful for testing a DUT's time transition characteristics at a certain fixed frequency by setting the span to zero. When the Δ mode is ON, this softkey shows a value relative to the Δ marker point.
 - **1/2 π F** Displays the relaxation time (the value of $1/2\pi$ frequency) instead of the marker stimulus value read-out. This capability is available for the frequency sweep only. When the Δ mode is ON, this softkey shows a value relative to the Δ marker point.
- **LEVEL MON []** Leads to the following softkeys, which are used to monitor output level of OSC level or dc bias. When this function is turned on, the output level on a marker point is displayed on the top right of the screen. This softkey does not appear if the user trace display is turned on.
 - **OFF** Turns off the level monitor function. The marker displays normal marker value.
 - **AC-V** Displays the voltage value of the OSC level on the marker points.
 - **AC-I** Displays the current value of the OSC level on the marker points.
 - **DC-V** Displays the voltage value of the dc bias on the marker points.
 - **DC-I** Displays the current value of the dc bias on the marker points.

Marker Function

Three Types of Markers

Three types of markers are provided for each channel. The first is **the active marker** (or the marker) that is displayed on the screen (as ∇) when **Marker**, **Marker→**, **Search**, or **Utility** is pressed. When a marker is turned on and no other function is active, the marker can be controlled with the knob, or the step keys. The second is **the sub-markers** that appear at the present marker position when a softkey in the sub-marker menu is pressed. The seven sub-markers can be displayed for each channel at the same time (a total of 14). The third is **the Δ marker** that defines a reference position of the delta mode. There are three Δ mode markers, Δ marker (normal), tracking Δ marker, and fixed Δ marker.

Marker Value

Markers have a stimulus value (the x-axis value in a Cartesian format) and a measurement value (the y-axis value in a Cartesian format). In a polar, Smith, admittance chart, or complex plane format, the second part of a complex data pair is also provided as an auxiliary measurement value.

The marker can be moved to any point on the trace. Its measurement and stimulus values are displayed at the top right corner of the graticule for each displayed channel (in units appropriate to the display format). The displayed marker measurement values are valid even when the measured data is above or below the range displayed on the graticule. When marker list is turned on, stimulus values and measurement values of all markers are listed on the graticule. In a polar, Smith, or admittance chart format, auxiliary measurement values of all markers are also listed.

X-axis Value to be Displayed

Stimulus Value

Normally, the marker displays the stimulus value at the current marker position for the x-axis value.

Time

When time is selected as the x-axis value to be displayed (instead of the marker value), the x-axis is changed to the time scale. The start point of the x-axis is 0 seconds and the stop point indicates the sweep time.

Relaxation Time ($1/2\pi f$)

When marker relaxation time ($1/2\pi f$) is selected as the x-axis value to be displayed (instead of the stimulus value), the x-axis is changed to the $1/2\pi f$ scale.

Marker Level Monitor

The analyzer has the capability to monitor the output voltage or current level of the OSC level or dc bias. When the level monitor is turned on, the level monitor value on a marker point is displayed on the screen.

The monitor value displayed is calculated from the current stimulus setting and the impedance value measured.

OSC level monitor value

The voltage value of the OSC level applied to the DUT (V_{dut}) and the current value of the OSC level flowing through the DUT (I_{dut}) are calculated using the following equations:

$$V_{dut} = V_{osc} \times \frac{Z_{meas}}{Z_{meas} + 50}$$

$$I_{dut} = V_{osc} \times \frac{1}{Z_{meas} + 50}$$

or

$$I_{dut} = I_{osc} \times \frac{50}{Z_{meas} + 50}$$

Where,

V_{osc} Voltage setting value of the OSC level

I_{osc} Current setting value of the OSC level

Z_{meas} Current measurement impedance value of the DUT

Continuous/Discrete Mode

Marker values are normally continuous (that is, they are interpolated between measured points). Alternatively, they can be set to read only discrete measured points.

Marker on the Data Trace or on the Memory Trace

If both data and memory are displayed, you can select which marker values apply to the data trace or the memory trace. If data or memory is displayed (not both), the marker values apply to the trace displayed. In a data math display (data+memory, data–memory, or data/memory), the marker values apply to the trace resulting from the memory math function.

Δ Mode

With the use of a delta marker, a delta marker mode is available that displays both the stimulus and measurement values of the marker relative to the reference. Any position on the trace or a fixed point can be designated as the delta marker. The Δ marker can be put on a current position of the marker. If the delta reference is the fixed Δ marker, both its stimulus value and its magnitude value (y-axis value) can be arbitrarily set anywhere in the display area (not necessarily on the trace). If the delta marker is the tracking Δ marker, its stimulus value can be controlled and its measurement value is the value of the trace at that stimulus value.

Marker Function

Marker Search Function

Markers can search for the trace maximum/minimum, any other point, peak maximum/minimum or peak-to-peak value of all or part of the trace. The marker and sub-markers can be used together to search for specified width cutoff points and calculate the width and Q. Statistical analysis uses markers to provide a readout of the mean, standard deviation, and peak-to-peak values of all or part of the trace.

When the format is polar, Smith, admittance chart, or complex plane format, the marker search function searches for the primary marker value (not the AUX value) of the point specified.

Applications for Marker Search on Complex Plan	
To search for the maximum absolute value of the complex impedance:	
1. Press	Utility SMTH/POLAR MENU LOG MAG PHASE
2. Press	Search MAX
To search for the maximum real part value of the complex impedance:	
1. Press	Utility SMTH/POLAR MENU REAL IMAG
2. Press	Search MAX
To search for the maximum resistance value (R) of the complex impedance:	
1. Press	Utility SMTH/POLAR MENU R+jX
2. Press	Search MAX

Width Function

The width search feature analyzes a resonator and calculates the center point, width, and quality factor (Q) for the specified bandwidth. These parameters depend on the Δ marker mode. The following table shows how each parameter is determined for each Δ marker mode.

Parameter	Tracking Δ Marker	Fixed Δ Marker
bandwidth	Displays the bandwidth value between the cutoff points set by WIDTH VALUE .	
Center	Displays the center stimulus value between the cutoff points (this is marked by sub-marker 1).	Displays the stimulus value difference between the center stimulus value of the cutoff points and the fixed Δ marker. (This is marked by sub-marker 1.)
Q	Displays the Q value (= cent/BW) of the trace.	
Peak	Displays the amplitude value at the peak of the lobe.	Displays the amplitude value difference between the amplitude value at the peak of the lobe and the amplitude value of the fixed Δ marker.
ΔF (left)	Displays the stimulus value difference between marker 2 and the center frequency specified by the Center key.	Displays the stimulus value difference between marker 2 and the fixed Δ marker.
ΔF (right)	Displays the stimulus value difference between marker 3 and center frequency specified by the Center key.	Displays the stimulus value difference between marker 3 and the fixed Δ marker.

Figure 7-13 shows an example of the bandwidth search feature.

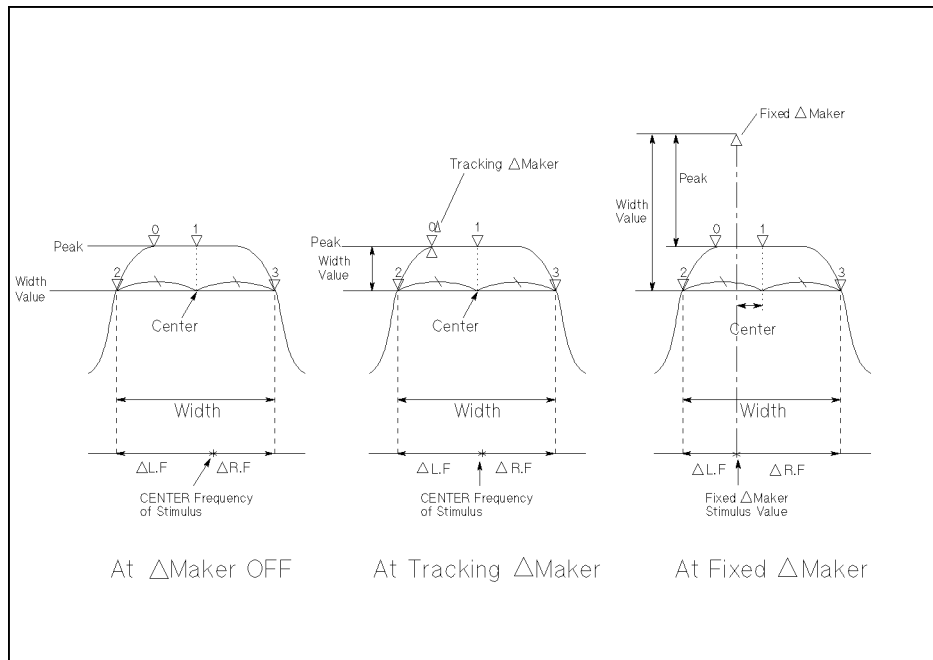

Figure 7-13. Bandwidth Search Example

Width Value

The width search function provides four ways to specify width value as follows:

Marker Function

- Enter the width value directory.
- Set a value that is the marker value divided by the square root of 2.
- Set a value which is the marker value multiplied by the square root of 2.
- Set a value which is the marker value divided by 2.

When Δ mode is ON, the width value is relative to the Δ marker.

Width Value

Width Value	Δ Marker OFF	Δ Marker ON
MKRVAL/ $(\sqrt{2})$	The active marker value divided by the square root of 2	The Δ marker value divided by the square root of 2
MKRVAL $\times(\sqrt{2})$	The active marker value multiplied by the square root of 2	The Δ marker value multiplied by the square root of 2
MKRVAL/2	The active marker value divided by 2	The Δ marker value divided by 2
FIXED	Absolute width value	Relative value to Δ marker

How to determine the quality factor (Q) of resonators

To determine the Q value using the anti-resonance point:

1. Press **[Search]** to make the marker active.
2. Press **SEARCH TRK on OFF** to change it to **SEARCH TRK ON off**. Then press **SEARCH:MAX** to move the marker to the anti-resonance point on the trace.
3. Press **[Search] WIDTH [off] WIDTH VALUE MKRVAL/ $(\sqrt{2})$ RETURN**
4. Press **WIDTH on OFF** to change it to **WIDTH ON off**. The width value, Q factor, and several parameters are displayed on the screen.

To determine the Q value using the resonance point:

1. Press **[Search]** to make the marker active.
2. Press **SEARCH TRK on off** to change it to **SEARCH TRK ON off**. Then press **MIN** to move the marker to the resonance point on the trace.
3. Press **[Search] WIDTH [OFF] WIDTH VALUE MKRVAL $\times(\sqrt{2})$ RETURN**
4. Press **WIDTH on OFF** to change it to **WIDTH ON off**. The width value, Q factor, and several parameters are displayed on the screen.

To determine the Q value using the admittance chart:

1. Press **[Utility]** to make marker active. Then press **SMTH/POLAR MENU G+jB** to read conductance and susceptance (assuming that the admittance circle has been displayed on the admittance chart).
2. Press **[Search] SEARCH TRK on off** to change it to **SEARCH TRK ON off**. Then press **Search:MAX** to move the marker to the point where the G value is maximum on the trace (resonance point).
3. Press **[Search] WIDTH [OFF] WIDTH VALUE MKRVAL/2 RETURN**
4. Press **WIDTH on OFF** to change it to **WIDTH ON off**. The width value, Q factor, and several parameters are displayed on the screen.

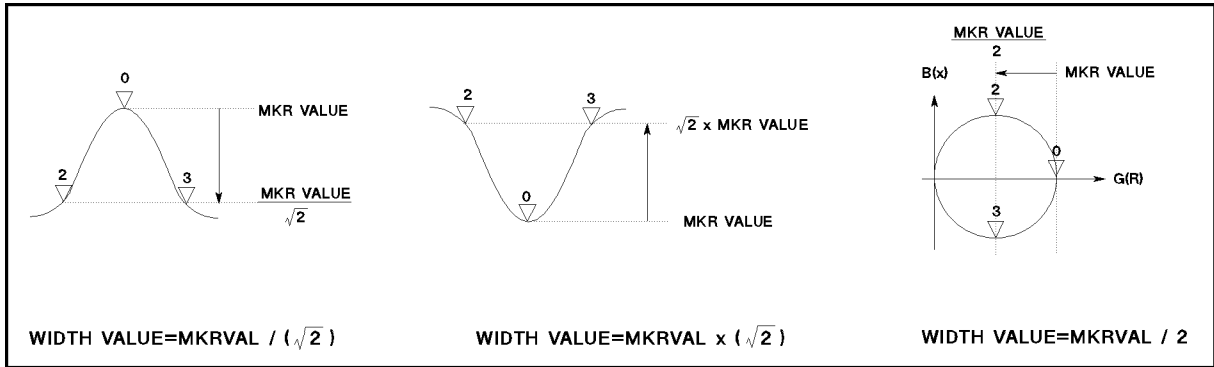

Figure 7-14. Q Measurement Examples

There are two kinds of Q parameters

Generally, two kinds of Q factors are used to characterize electric devices, the impedance parameter *Q factor* and the *Q value* of a coil or resonator. However, these Q factors are quite different. The definitions of them are as follows:

Q factor of Impedance Parameter

This Q factor is ratio of the resistance and reactance (or conductance and susceptance):

$$Q = \frac{X}{R}$$

Where, *R* is resistance, *X* is reactance.

Q value of Width Parameter

This Q factor is the ratio of the bandwidth and center frequency of the trace:

$$Q = \frac{BW}{CENTER}$$

Where, *BW* is bandwidth, *CENTER* is center frequency.

Marker Function

Peak Definition

The search function provides the define peak feature, which specifies the properties of the peaks searched for by the peak search function. The define peak feature also allows the peak search function to discriminate peaks from noise.

Peak Definition

The following parameters are used in the peak definition:

- Peak polarity (positive or negative)
- ΔX , ΔY (gradient)
- Threshold value

The search functions search for a peak where the parameters of the peak match the following conditions:

$$\frac{\Delta Y}{\Delta X} \times SPAN \leq \min(\Delta y_L, \Delta y_R)$$

and

$$Threshold \leq Peak Amplitude Value$$

Where,

Δy_L and Δy_R are the difference in amplitude value between a peak and the adjacent measurement points on both sides.

That is, the search functions search for a peak where, the gradient is greater than $\Delta Y/\Delta X$, and the amplitude is greater than the threshold value. The search functions ignore a peak when the amplitude value is less than the threshold even if the peak polarity is set to negative.

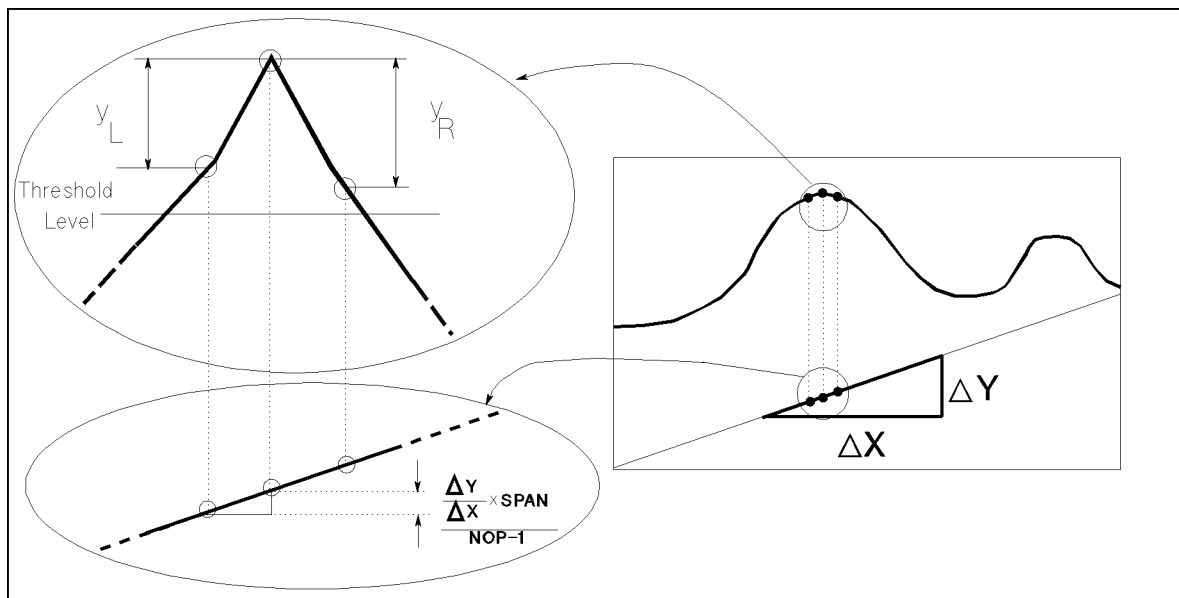
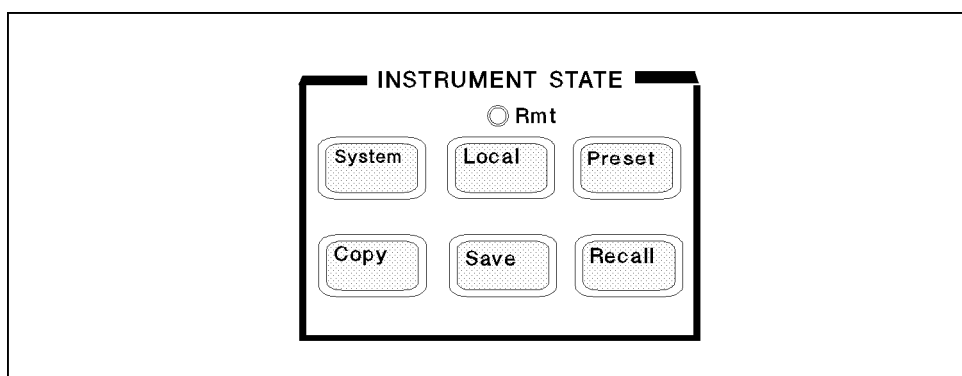

Figure 7-15. Peak Definition

Instrument State Block

The instrument state block keys and associated menus control channel-independent system functions. These include controller modes, analyzer addresses, real time clock, limit lines and limit testing, HP Instrument BASIC, beeper, or printing, saving instrument states and data on a built-in disk or memory disk, and the preset state.



06008001

Figure 8-1. Instrument State Block

- System** Controlling HP Instrument BASIC.
Adjusting the internal real time clock that is used to print the current time and date on the head of a hard copy.
Toggling Beeper ON/OFF.
Making Limit Lines and executing Limit Testing.
Service Menu (used for testing). See the *Service Manual* for more information. The *Service Manual* is furnished with Option 0BW.
- Local** Setting GPIB mode and addresses.
- Preset** Presetting State.
- Copy** Printing screen image, listing measurement data and operating parameters, calibration kit parameters, list sweep table, and limit test table.
- Save** Saving the instrument state and/or data to the built-in disk or memory disk.
- Recall** Recalling the instrument state and/or data from the built-in disk or memory disk.

Functions accessed from this block	You can access from ...	See the following section in this chapter:
Beep on, off	System	<i>Beep menu</i>
Cal kit definition table	Copy	<i>Copy menu</i>
Clock	System	<i>Clock menu</i>
Delete file	Save	<i>Save menu</i>
HP Instrument BASIC	System	<i>Instrument BASIC menu</i>
GPIB address	Local	<i>Local menu</i>
Initialize disk	Save	<i>Save menu</i>
Limit test table	Copy	<i>Copy menu</i>
Limit testing/Limit line	System	<i>Limit Test menu</i>
List measurement value	Copy	<i>Copy menu</i>
List sweep table	Copy	<i>Copy menu</i>
Memory size for memory disk	System	<i>Memory partition menu</i>
OPEN, SHORT, LOAD definitions for fixture compensation	Copy	<i>Copy menu</i>
Operating parameter list	Copy	<i>Copy menu</i>
Preset instrument	Preset	
Print display	Copy	<i>Copy menu</i>
Recall state/data from the floppy disk and memory disk	Recall	<i>Recall menu</i>
Save state/data to the floppy disk and memory disk	Save	<i>Save menu</i>
System controller / Addressable	Local	<i>Local menu</i>

For Additional Information on ...	See ...
Preset values and Setting Range of each function setting value	Appendix B in this manual
All Softkey Trees	Appendix C in this manual
GPIB Command Reference	GPIB Command Reference in the <i>Programming Manual</i>
How to control the 4291B using an external controller or the HP Instrument BASIC capability through the GPIB.	<i>Programming Manual</i>

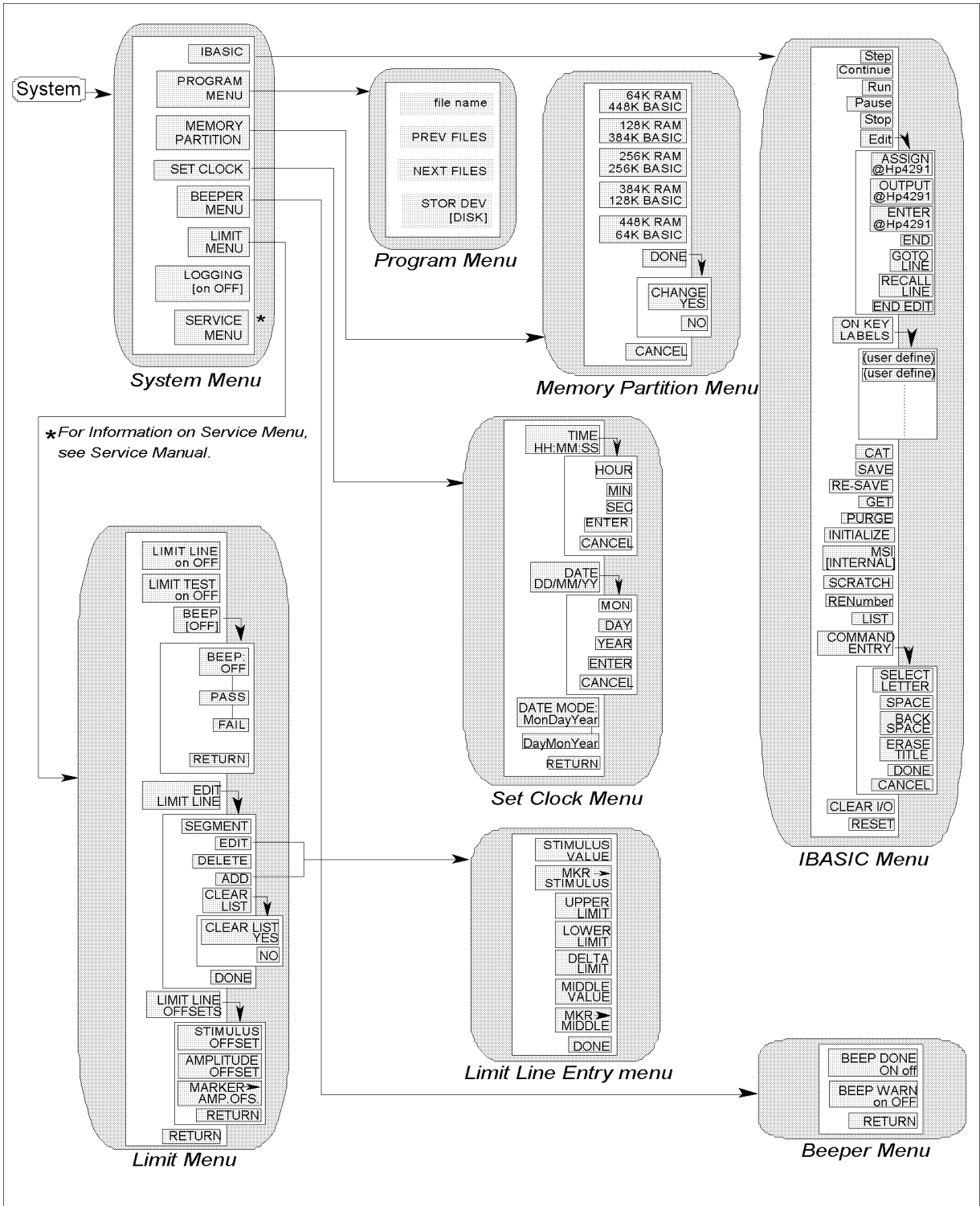

CE008037

Figure 8-2. Softkey Menus Accessed from the **System** Key

System Menu

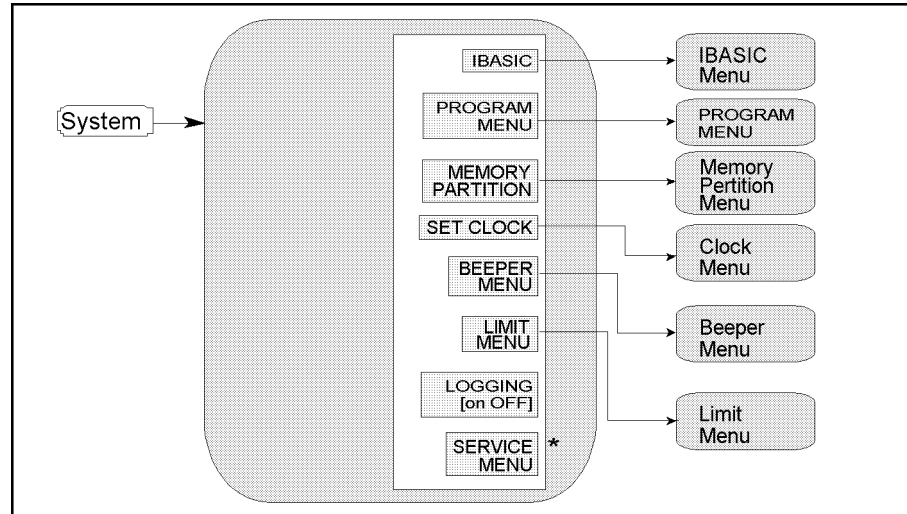

CE008003

Figure 8-3. System Menu

- **IBASIC** Displays the menu used to operate HP Instrument BASIC.
- **PROGRAM MENU**
- **MEMORY PARTITION** Changes the size of memory areas for HP Instrument BASIC and the memory disk.
- **SET CLOCK** Displays the series of menus that set an internal clock.
- **BEEPER MENU** Displays the series of menus that set a beeper.
- **LIMIT MENU** Displays the series of menus that defines limits or specifications used to test a DUT.
- **LOGGING ON off** Turns the logging mode on or off. When logging is ON, the analyzer logs the equivalent GPIB commands of all front panel key inputs into the HP Instrument BASIC program.

Logging Function

- When an Instrument BASIC program is running, waiting for an input, or being edited, logging cannot be turned on.
- When the analyzer does not have a program loaded, the following statements are automatically inserted at the beginning and the end of the program.

```

ASSIGN @Hp4291 TO 800
END

```
- When there are already some statements in the Instrument BASIC editor, the program lines logged are inserted at the current cursor line.
- The short form of the command is logged and the suffix (unit of parameter) is omitted.
- If the command logged exceeds the memory capacity for the Instrument BASIC, error will occur.
- If you make an input error when logging is ON, the analyzer generates the equivalent codes faithfully and the resulting program is incorrect.
- The logging function does not truncate the repeated nodes of the SCPI command. This makes program lines longer than necessary.
- The logging function does not take into consideration the requirements of a timing sensitive operation such as triggering or a fixture compensation procedure. Therefore, you need to add or rewrite the lines for that part of a program to run correctly.

- **SERVICE MENU** Displays the series of service menus described in the *Service Manual*. The *Service Manual* is furnished with Option 0BW.

Instrument BASIC menu

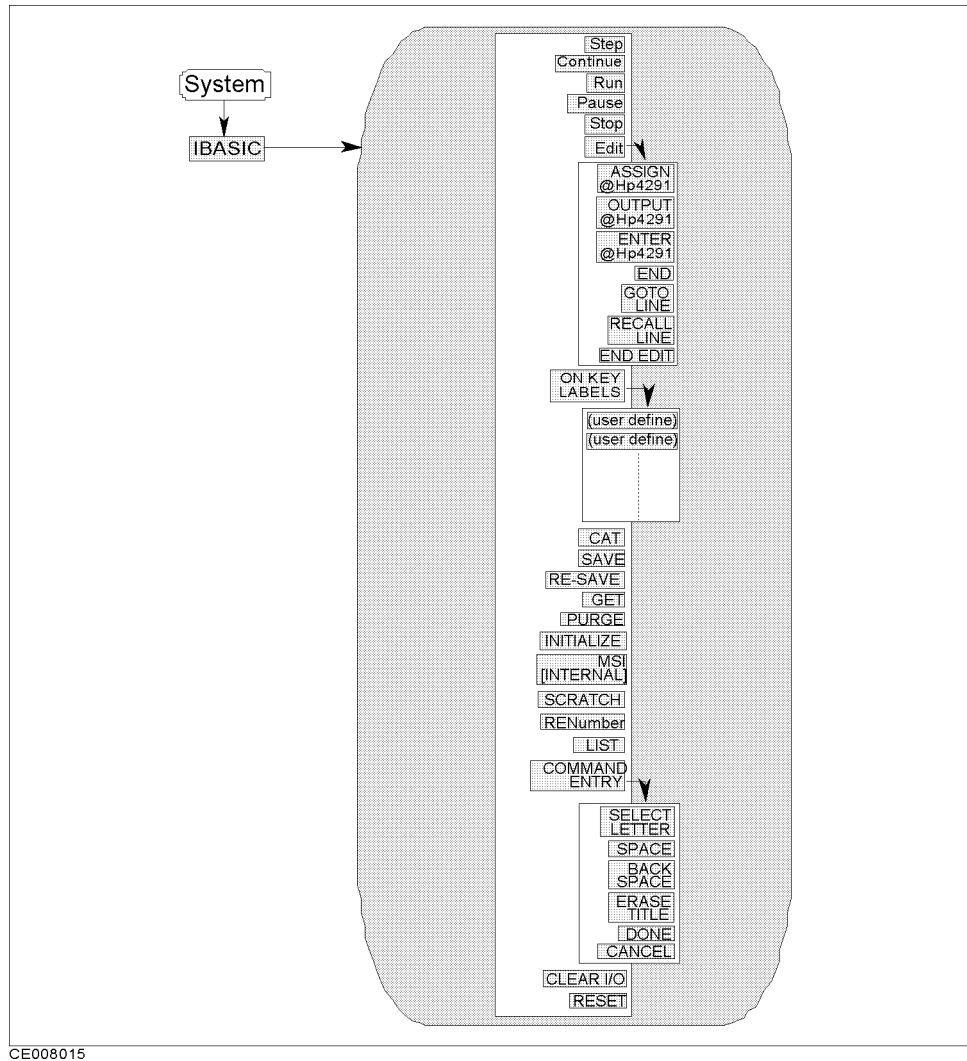

Figure 8-4. Instrument BASIC Menu

Step Allows you to execute one program line at a time. This is particularly useful for debugging.

Continue Resumes program execution from the point where it paused.

Run Starts a program from its beginning.

Pause Pauses program execution after the current program line is executed.

Stop Stops program execution after the current line. To restart the program, press **Run**.

Edit Enters into the EDIT mode. In the EDIT mode, the following softkeys are displayed on the softkey menu area.

ASSIGN @Hp4291 Produces the command ASSIGN @Hp4291 TO 800 at the cursor's current position.

OUTPUT @Hp4291 Produces the command OUTPUT @Hp4291;" at the cursor's current position.

ENTER @Hp4291 Produces the command ENTER @Hp4291; at the cursor's current position.

END Produces the command END.

GOTO LINE Allows you to move the cursor to any line number or to a label. After pressing **GOTO LINE**, type a line number or a label and then press **(Return)**. The cursor moves to the specified line or label.

RECALL LINE Recalls the last deleted line.

END EDIT Exits the edit mode.

CAT Enters the CAT command in the BASIC command line. The CAT command displays the list of files on a disk.

SAVE Enters the SAVE command in the BASIC command line. The SAVE command saves a program as an ASCII file.

RE-SAVE Enters the RE-SAVE command in the BASIC command line. The RE-SAVE command overwrites an old file with a new one using the same file name .

GET Enters the GET command in the BASIC command line. The GET command loads a specified ASCII file into the editor memory.

PURGE Enters the PURGE command in the BASIC command line. The PURGE command deletes a specified file.

INITIALIZE Enters the INITIALIZE command in the BASIC command line. The INITIALIZE command formats a disk.

MSI [INTERNAL] The MSI [INTERNAL] command specifies a disk device. INTERNAL selects the floppy disk; MEMORY selects the memory disk.

SCRATCH Enters the SCRATCH command in the BASIC command line. Pressing the **(Return)** key after the command deletes a currently edited program from the memory.

RENumber Enters the RENumber command in the BASIC command line. Pressing the **(Return)** key after the command rennumbers the line numbers of a program.

LIST Enters the LIST command in the BASIC command line. The LIST command outputs the program list to the screen.

COMMAND ENTRY Displays the softkeys that are used to enter BASIC commands. The active entry area displays the letters, digits, and some special characters. Three sets of letters can be scrolled using the step keys, **(↑)** and **(↓)**.

SELECT LETTER Selects the character pointed to by “↑”.

SPACE Inserts a space.

BACK SPACE Deletes the last character entered.

ERASE TITLE Deletes all characters entered.

DONE Terminates command entry and executes the command you entered.

CANCEL Cancels command and returns to the previous menu.

CLEAR I/O Enters the CLEAR I/O command in the BASIC command line. The CLEAR I/O command causes the execution of an I/O-related command to pause. Press Continue to resume the execution.

RESET Enters the RESET command in the BASIC command line. The RESET command terminates program execution without confirmation.

Program Menu

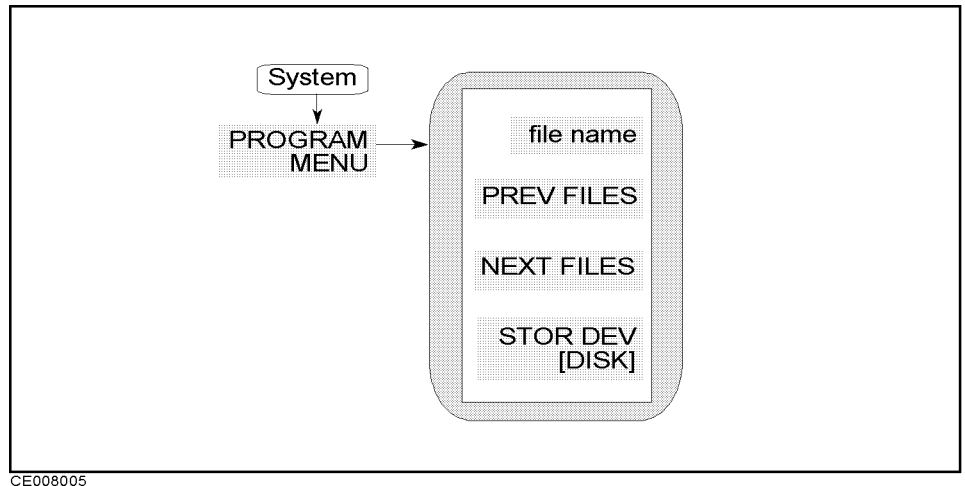

CE008005

Figure 8-5. Program Menu

- **file name** Shows IBASIC program file names in the floppy disk or memory disk.
- **PREV FILES** Shows previous program file list.
- **NEXT FILES** Shows next program file list.
- **STOR DEV []** Select a storage system to floppy disk or memory disk. **[DISK]** means the floppy disk drive and **[MEMORY]** means the memory disk.

Memory Partition Menu

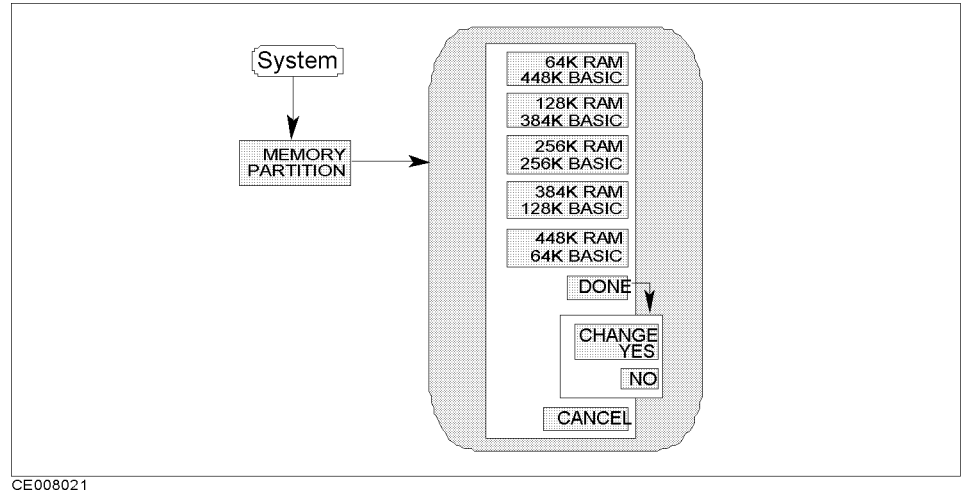

Figure 8-6. Memory Partition Menu

- **mmK RAM nnK BASIC** Selects the memory partitions so that *mm* Kbytes are used for memory disk and *nn* Kbytes are used for array of HP Instrument BASIC. In fact, the analyzer displays the sizes of the memory disk and the BASIC area, instead of *mm* and *nn*.
- **DONE** Displays **CHANGE YES** and **NO** softkey to execute or cancel the change.
 - **CHANGE YES** Changes the memory partition to the one selected and presets the instrument.
 - **NO** Cancels the change to the memory partition and returns to the previous softkey menu.

When the memory partition is changed ...

When the memory partition is changed, the following settings are also changed:

- The analyzer setting becomes the preset state.
- The Instrument BASIC program in the program editor is lost.
- All data in the memory disk and backup of the memory disk is lost.

Clock Menu

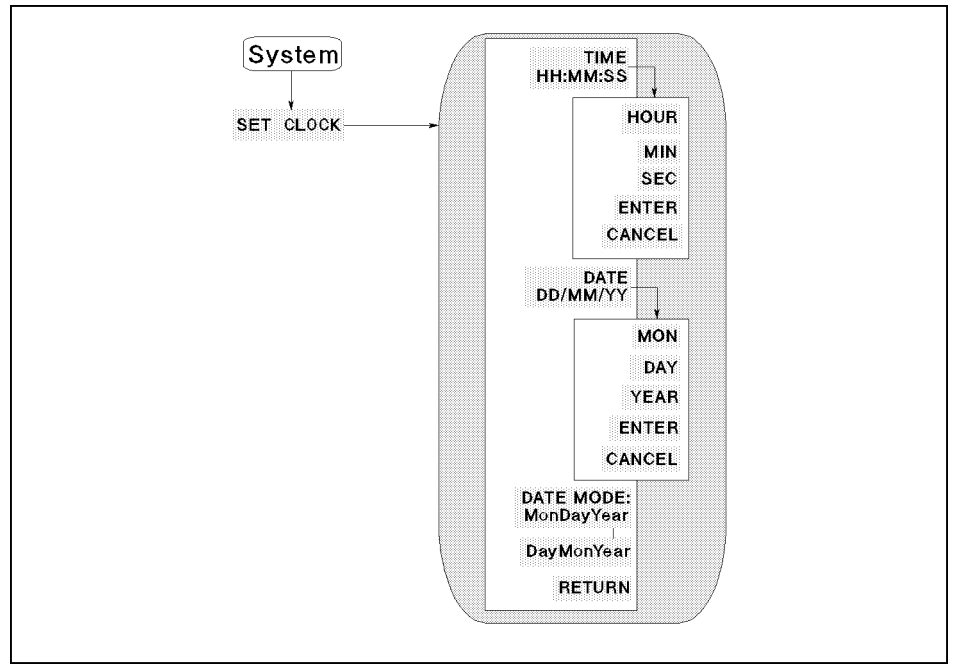
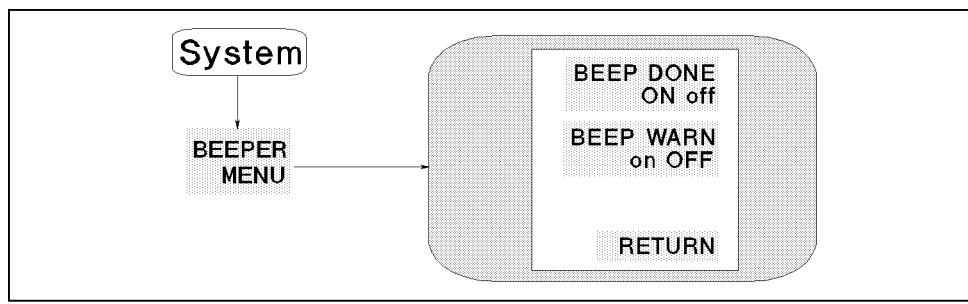

Figure 8-7. Clock Menu

- **TIME HH:MM:SS** Displays the current time on the active entry area and displays the next page to adjust time.
 - **HOUR** Enables changing the hour setting using the knob or the numeric entry keys. After you change the hour setting, press **ENTER** to restart the clock.
 - **MIN** Enables changing the minute setting using the knob or the numeric entry keys. After you change the minute setting, press **ENTER** to restart the clock.
 - **SEC** Enables changing the second setting using the knob or the numeric entry keys. After you change the second setting, press **ENTER** to restart the clock.
 - **ENTER** Restarts the internal clock.
 - **CANCEL** Returns to the previous page. Pressing this key does not affect the internal clock setting.
- **DATE DD/MM/YY** Displays the current date on the active entry area to adjust date.
 - **MON** Enables changing the month setting using the knob or the numeric entry keys. After you change the month setting, press **ENTER** to restart the clock.
 - **DAY** Enables changing the day setting using the knob or the numeric entry keys. After you change the day setting, press **ENTER** to restart the clock.
 - **YEAR** Enables changing the year setting using the knob or the numeric entry keys. After you change the year setting, press **ENTER** to restart the clock.

- **ENTER** Restarts the internal clock.
- **CANCEL** Returns to the previous page. Pressing this key does not affect the internal clock setting.
- **DATE MODE: MonDayYear** Changes the displayed date to the “month:day:year” format.
- **DayMonYear** Changes the displayed date to the “day:month:year” format.

Beeper Menu

CG006017

Figure 8-8. Beeper Menu

- **BEEP DONE ON off** Toggles an annunciator that sounds to indicate the completion of operations such as calibration or instrument state save.
- **BEEP WARN ON off** Toggles the warning annunciator. When the annunciator is ON it sounds a warning when a cautionary message is displayed.

Limit Test Menu

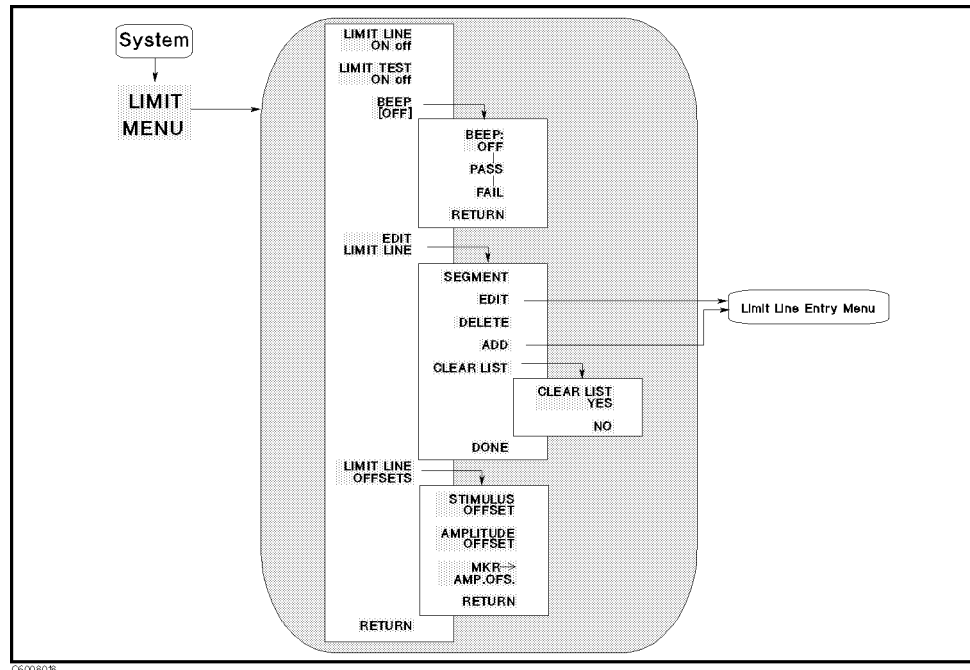

Figure 8-9. Limit Test Menu

- LIMIT LINE ON off** Turns limit lines ON or OFF. If limits have been defined and limit lines are turned on, the limit lines are displayed for visual comparison of the measured data in all Cartesian formats.

Limit lines can be saved on disk

If limit lines are defined, they are always saved on disk with an instrument state.

Limit line table can be listed.

Copy function (accessed from Copy key) can list a limit line table. In a listing of values with limit lines on and limit test on, the upper limit and lower limit are listed together with the pass or fail margin, as long as other listed data allows sufficient space.
--

- LIMIT TEST ON off** Turns limit testing ON or OFF. When limit testing is ON, the data is compared with the defined limits at each measured point. Limit tests occur at the end of each sweep, whenever the data is updated, and when limit testing is first turned ON.

Limit testing is available for both magnitude and phase values in Cartesian formats. In the polar, Smith, admittance chart, and complex plane formats, the value tested depends on the marker mode and is the magnitude or the first value in a complex pair. The message "NO LIMIT LINES DISPLAYED" is displayed in polar, Smith, admittance chart, and complex plane formats if limit lines are turned ON.

Four different ways to indicate pass or fail status

When limit testing is ON, the following four different indications of pass or fail status are provided:

- A PASS or FAIL message is displayed at the right of the display.
- The limit beeper sounds if it is turned on.
- In a listing of values using the copy menu, an asterisk * is shown next to any measured point that is out of limits.
- A bit is set in the GPIB status byte.

- **BEEP []** Leads to the following softkeys, which are used to turn on or off the limit pass or fail beep. The limit beeper is independent of the warning beeper and the operation complete beeper, both of which are described in the “Beeper Menu.”
 - **OFF** Turns the limit beeper off.
 - **PASS** Turns the limit passes beeper on. When limit testing is ON and the pass beeper is ON, a beep is emitted each time a limit test is performed and a pass is detected.
 - **FAIL** Turns the limit fails beeper on. When limit testing is ON and the fail beeper is ON, a beep is emitted each time a limit test is performed and a failure is detected.
- **EDIT LIMIT LINE** Displays a table of limit segments on the lower half of the display. Also leads to the following softkey, which is used to define or change limits.
 - **SEGMENT** Specifies which limit segment in the table to edit. The list can be scrolled up or down to show other segment entries. The pointer “>” shows the segment that can be edited or deleted. The pointer can be moved using the entry block. If the table of limits is designated EMPTY, new segments can be added using **ADD** or **EDIT**.
 - **EDIT** Displays the *Limit Line Entry* menu that defines or modifies the stimulus value and limit values of a specified segment. If the table is empty, a default segment is displayed.
 - **DELETE** Deletes the segment indicated by the pointer “>.”
 - **ADD** Displays the *Limit Line Entry* menu and adds a new segment to the end of the list. The new segment is initially a duplicate of the segment indicated by the pointer “>” and selected using **SEGMENT**. If the table is empty, a default segment is displayed. The maximum number of segments is 18.
 - **CLEAR LIST** Displays the following softkeys and clears all the segments in the limit test.
 - **CLEAR LIST YES** Clears all the segments in the limit line table and returns to the previous menu.
 - **NO** Cancels clearing the segments and returns to the edit limit menu.
 - **DONE** Sorts the limit segments and displays them on the display in increasing order of stimulus values.
- **LIMIT LINE OFFSETS** Displays the following three softkeys that offset the complete limit set in either stimulus or amplitude value.
 - **STIMULUS OFFSET** Adds to or subtracts an offset from the stimulus value. This allows limits already defined to be used for testing in a different stimulus range.

- **AMPLITUDE OFFSET** Adds or subtracts an offset in amplitude value. This allows previously defined limits to be used at a different power level.
- **MKR—AMP.OFS.** Move the limits so that they are centered an equal amount above and below the marker at that stimulus value.

Note



For information on the limit line concept, see “Limit Line Concept” later in this chapter.

Limit Line Entry Menu

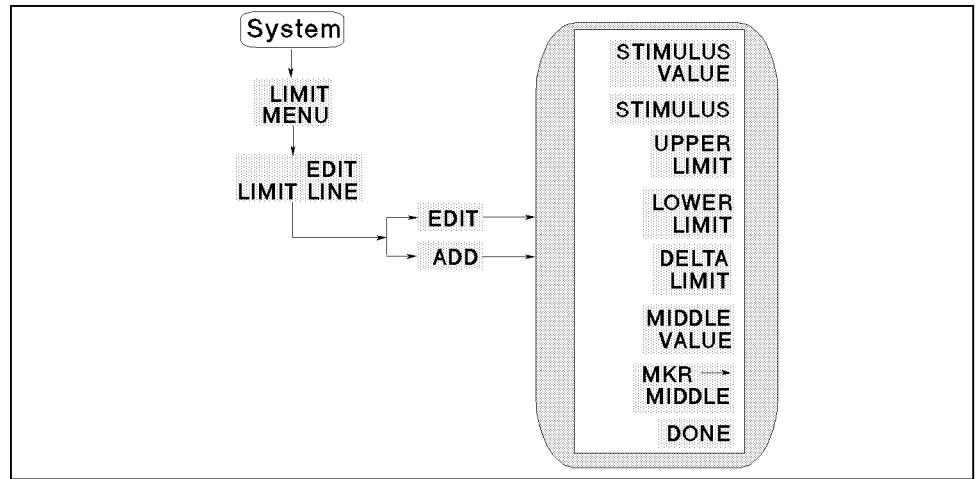

Figure 8-10. Limit Line Entry Menu

- **STIMULUS VALUE** Sets the starting stimulus value of a segment using the entry block controls.
- **MKR—STIMULUS** Changes the segment stimulus value to the present marker stimulus value.
- **UPPER LIMIT** Sets the upper limit value for the segment. Upper and lower limits must be defined. If no upper limit is required for a particular measurement, force the upper limit value out of range (for example, +1 G)

When **UPPER LIMIT** or **LOWER LIMIT** is pressed, all the segments in the table are displayed in terms of upper and lower limits, even if they were defined as delta limits and middle value.

If you attempt to set an upper limit that is lower than the lower limit, or vice versa, both limits will be automatically set to the same value.

- **LOWER LIMIT** Sets the lower limit value for the segment. Upper and lower limits must be defined. If no lower limit is required for a particular measurement, force the lower limit value out of range (for example, -1 G).
- **DELTA LIMIT** Sets the limits an equal amount above and below a specified middle value, instead of setting upper and lower limits separately. This is used in conjunction with **MIDDLE VALUE** or **MARKER → MIDDLE**, to set limits for testing a device that is specified at a particular value plus or minus an equal tolerance.

When **DELTA LIMITS** or **MIDDLE VALUE** is pressed, all the segments in the table are displayed in these terms, even if they were defined as upper and lower limits.

- **MIDDLE VALUE** Sets the midpoint for **DELTA LIMITS**. It uses the entry controls to set a specified amplitude value vertically centered between the limits.

- **MKR→MIDDLE** Sets the midpoint for **DELTA LIMITS** using the marker to set the middle amplitude value of a limit segment. Moves the limits so that they are automatically set an equal amount above and below the present marker amplitude value.
- **DONE** Terminates a limit segment definition and returns to the last menu.

Note



For information on the limit line concept, see “Limit Line Concept” later in this chapter.

This key performs the following functions:

- Returns front panel control to the user. The analyzer ignores all front panel keys (except the local key) when under the control of an external computer. The analyzer is in “local mode” when the user has front panel control. The analyzer is in the “remote mode” when an external computer controls the analyzer.
- Gives access to the GPIB menu that sets the controller mode and to the address menu (where the GPIB addresses of the analyzer and peripheral devices are entered). Only one active controller can control the bus in a multiple-controller system. The controller mode determines which device is system controller and which acts as the master controller (and can regain active control at any time in a multiple-controller system).

Local Menu

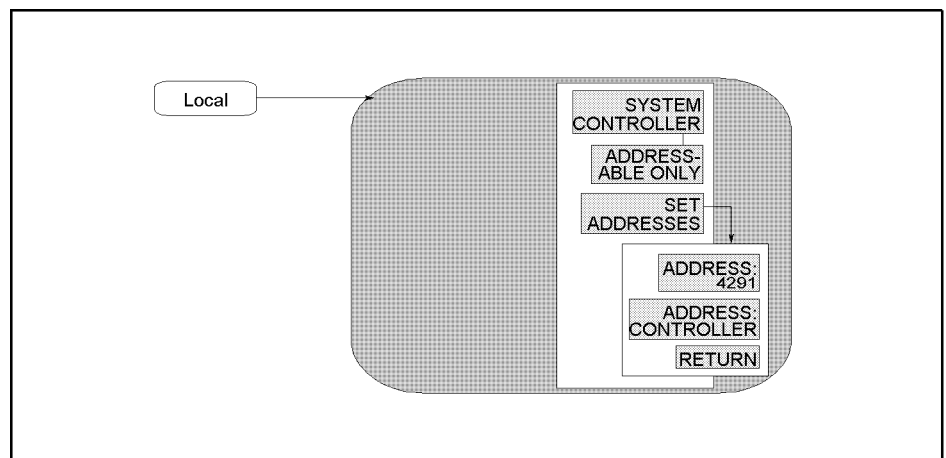

CE008010

Figure 8-11. Local Menu

- **SYSTEM CONTROLLER** Sets the analyzer as the system controller. This mode is used when peripheral devices are to be used and there is no external controller.

This mode can only be selected manually from the analyzer’s front panel and can be used only if no active system controller is connected to the system through GPIB. If you try to set system controller mode when another system controller is present, the message “CAUTION: CAN’T CHANGE - ANOTHER CONTROLLER ON BUS” is displayed.

- **ADDRESSABLE ONLY** Sets the analyzer as addressable only. This mode is used when an external controller controls peripheral devices or the analyzer.
- **SET ADDRESS:** Displays the following softkeys:
 - **ADDRESS: 4291** Sets the GPIB address of the analyzer. There is no physical address switch to set in the analyzer.
 - **ADDRESS: CONTROLLER** Sets the GPIB address the analyzer will use to communicate with the external controller.

Local

The analyzer keeps the setting of the GPIB mode and GPIB addresses in the battery backup memory, even if the analyzer is turned off.

Preset

Preset key presets the instrument state to the preset default value. The preset default values are listed in Appendix B. Preset has no effect on the following states:

- Display Allocation
- Display Adjustment
- Color Adjustment
- Clock Time/Date
- Limit Line Table
- GPIB Address
- GPIB Mode (system controller and addressable)
- User Cal Kit Definition
- User Compensation Kit Definition
- Fixture Selection (Impedance, Permittivity, and Permeability)

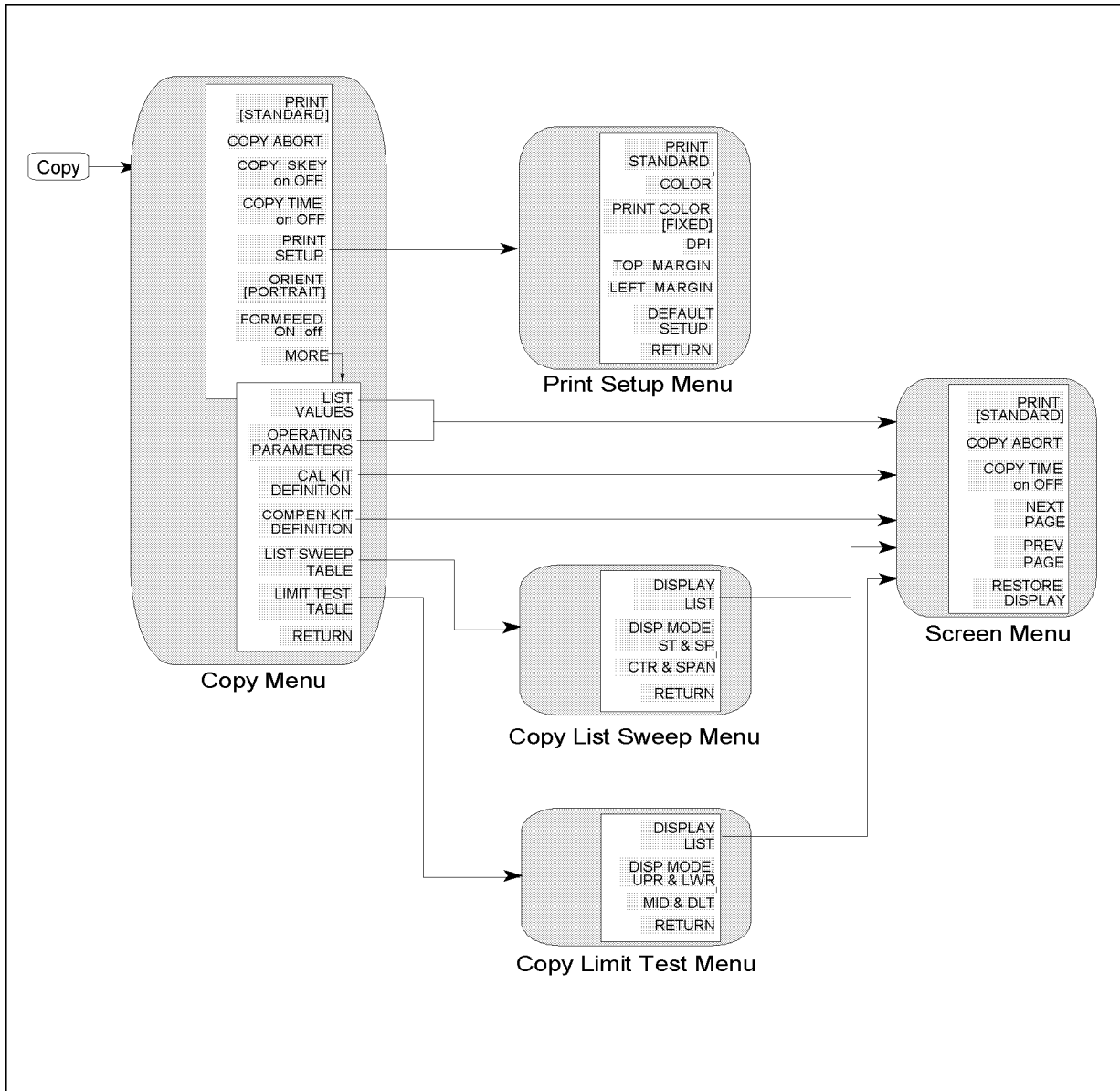

CE008011

Figure 8-12. Softkey Menus Accessed from the Copy Key

Copy Menu

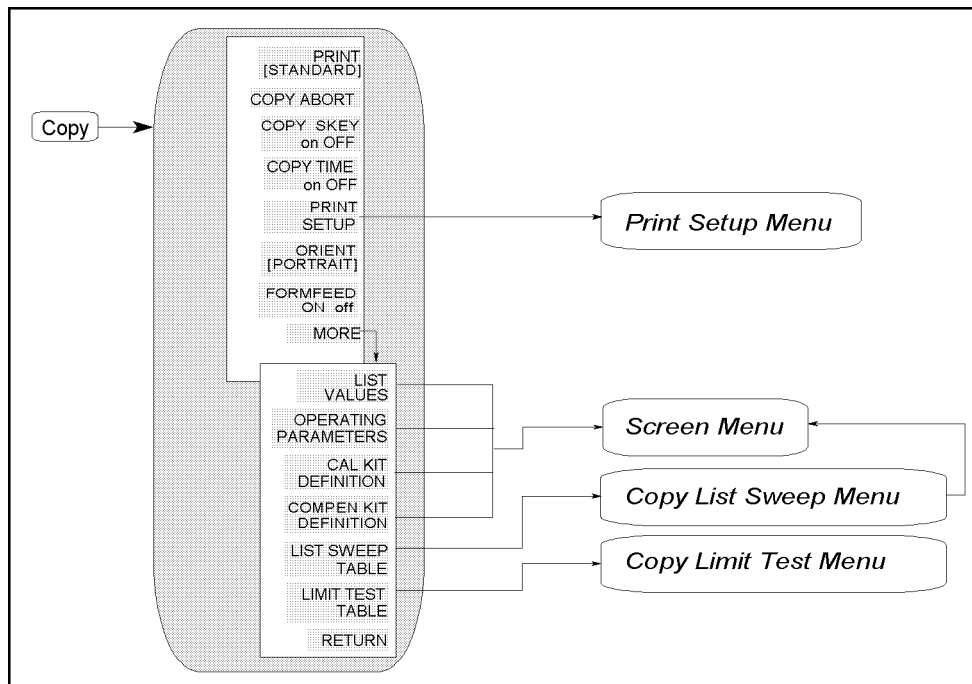

CE008022

Figure 8-13. Copy Menu

- **PRINT [STANDARD]** Causes an exact copy of the display to be printed. The softkey label identifies the printer selected in the print setup menu:

STANDARD	For a black and white printer
COLOR	For a color printer.

- **COPY ABORT** Aborts a print in progress.
- **COPY SKEY on OFF** Specifies whether to print out softkey labels by switching ON/OFF
- **COPY TIME ON off** Turns the “time stamp” on or off for a print, the time and date are printed out first, followed by the information shown on the display. See “Clock Menu” for setting the internal clock.
- **PRINT SETUP** Leads to the *Print Setup menu*, which is used to allow you to copy the display to a printer. For information on compatible printers, see the Chapter 12 in this manual set.
- **ORIENT [PORTRAIT]** Specifies the orientation of printer sheets. If your printer does not support landscape printing, this setting is ignored.

PORTRAIT	Portrait orientation
LANDSCAPE	Landscape orientation

- **FORMFEED ON off** Specifies whether to deliver a sheet after one screen is printed out by switching ON/OFF. When the sheet

orientation is specified to LANDSCAPE, the FORMFEED setting is ignored and sheets are always ejected after each screen printout.

- **LIST VALUES** provides a tabular listing of all the measured data points and their current values. When **DUAL CHAN** and **COUPLED CHAN** are **ON**, the measured values of both channels are listed at the same time. When **LIMIT LINE** and **LIMIT TEST** are **ON**, the limit information is also listed together with the measured values. The *Screen menu* is displayed to enable hard copy listings and access new pages of the table.

Table 8-1 shows the data listed on the screen when **DUAL CHAN** and/or **COUPLED CHAN** are **OFF**. The margin listed is the smaller of the difference values between the measurement value and either the upper or lower limit. A plus margin means the test passed and a minus margin means it failed.

Table 8-1. List Value Format

Display Format	Values Listed				
	1st column	2nd column	3rd column	4th column	5th column
LIN Y-AXIS LOG Y-AXIS	Sweep Parameter	Measurement Data ¹	Margin ²	Upper Limit Value ²	Lower Limit Value ²
SMITH CHART POLAR ADMITTANCE CHART COMPLEX PLANE	Sweep Parameter	Measurement Data ¹	Measurement Data	Upper Limit Value ²	Lower Limit Value ²

1 An * is displayed at the left of the measurement value when it fails the limit testing.

2 This is listed when the limit test is on.

The analyzer can list the values measured on both channels

When the dual channel is turned on and both channels are coupled, the sweep parameter value is listed in the first column, the measurement data of the active channel is listed in the second and third columns, and the non-active channel data is listed in the fourth and fifth columns. The values listed for each channel are the same as the data listed in the second and third columns in Table 8-1.

- **OPERATING PARAMETERS** Displays the *Screen menu* and provides a tabular listing on the display of the key parameters for both channels. The *Screen menu* is presented to allow hard copy listings and access new pages of the table.

Parameters listed by OPERATION PARAMETERS
The following operating parameters are listed in four pages: <ul style="list-style-type: none"><input type="checkbox"/> Sweep Source<input type="checkbox"/> Sweep Type<input type="checkbox"/> Number of Points<input type="checkbox"/> CAL Kit<input type="checkbox"/> CAL Type<input type="checkbox"/> Test Head<input type="checkbox"/> Fixture<input type="checkbox"/> Port Extension<input type="checkbox"/> Material Size (Option 002 only)<input type="checkbox"/> Calibration States<input type="checkbox"/> Compensation States<input type="checkbox"/> Trigger Source<input type="checkbox"/> Trigger Polarity

- **CAL KIT DEFINITION** Displays the *Screen menu* and lists the standard definition of the cal kit.
- **COMPEN KIT DEFINITION** Displays the *Screen menu* and lists the standard definition of the OPEN, SHORT and LOAD standard for fixture compensation.
- **LIST SWEEP TABLE** Displays the *copy list sweep menu* that can display a tabular listing of the list sweep table and print or plot it.
- **LIMIT TEST TABLE** Displays the *copy limit test menu* that can display a tabular listing of the limit value for limit testing and print or plot it.

Print Setup Menu

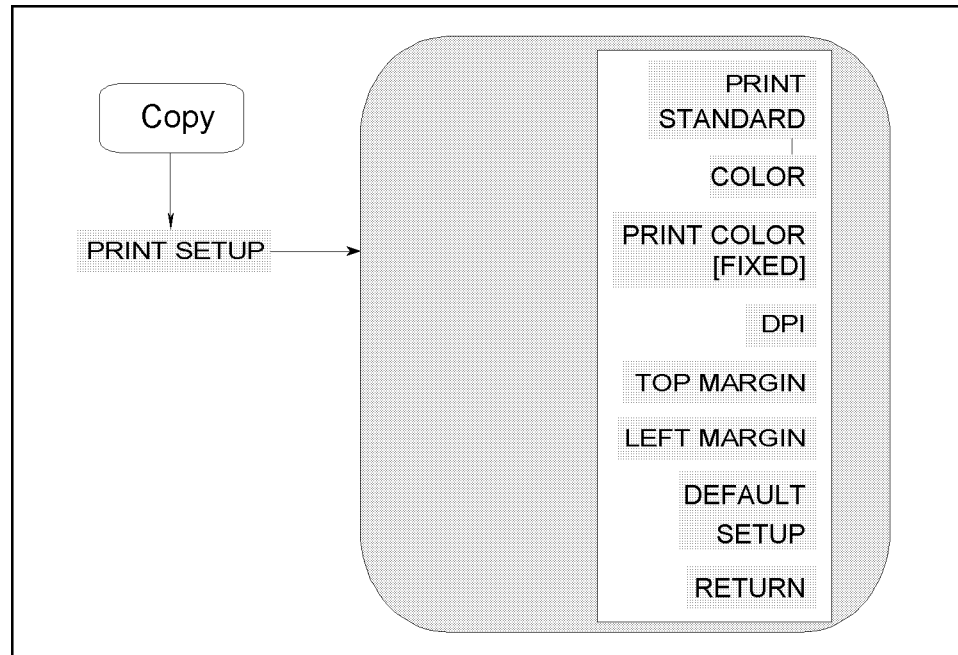

CE008041

Figure 8-14. Print Setup Menu

- **PRINT STANDARD** Sets the print command to the default selection (a standard printer that prints in black only or a color printer to yield a black-only print).
- **COLOR** Sets the print command to a default of color. The **PRINT [COLOR]** command does NOT work with a black and white printer.
- **PRINT COLOR [FIXED]** Toggles the printing color between **[FIXED]** and **[VARIABLE]**. If **FIXED** is selected, the analyzer prints a hard copy with default colors. If **VARIABLE** is selected, the analyzer prints a hard copy with colors as similar as possible to the display colors (that can be adjusted). See “**Display**” in Chapter 5 for display colors adjustment.

Because of the limited number of printer ink colors, the printed color is not always the same as the displayed color.

- **DPI** Specifies the resolution of a printer used for printing by dpi. The range of settable resolution is between 75 and 600 dpi.
- **TOP MARGIN** Specifies the top margin of printing by inch. The settable margin range is between 0 and 5 inches in step of 0.1 inch.
- **LEFT MARGIN** Specifies the left margin of printing by inch. The settable margin range is between 0 and 5 inches in step of 0.1 inch.
- **DEFAULT SETUP** Resets the printing parameters to the following default settings.

- Printing resolution: 75 dpi
- Form feed: ON
- Sheet orientation: Portrait
- Softkey label printing: OFF
- Top margin: 1.0 inch
- Left margin: 1.0 inch

Copy Limit Test Menu

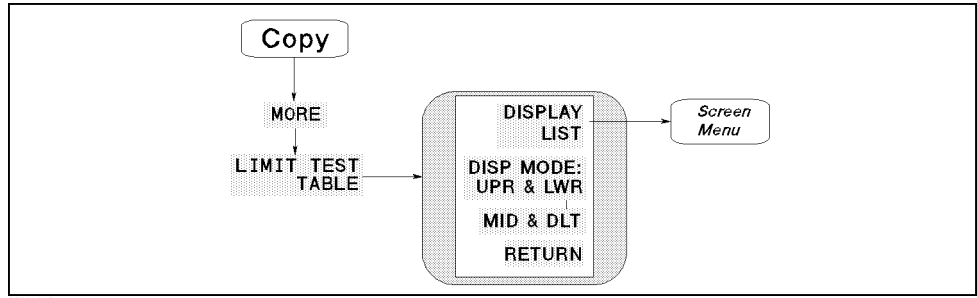

Figure 8-15. Copy Limit Test Menu

- **DISPLAY LIST** Displays the limit testing table and the *Screen menu* to prepare for hard copy.
- **DISP MODE:UPR & LWR** Selects the upper and lower formats that display the upper limit and lower limit values.
- **MID & DLT** Selects the middle and delta formats that display the middle value and the maximum deviation (limit value) from the middle value.

Copy List Sweep Menu

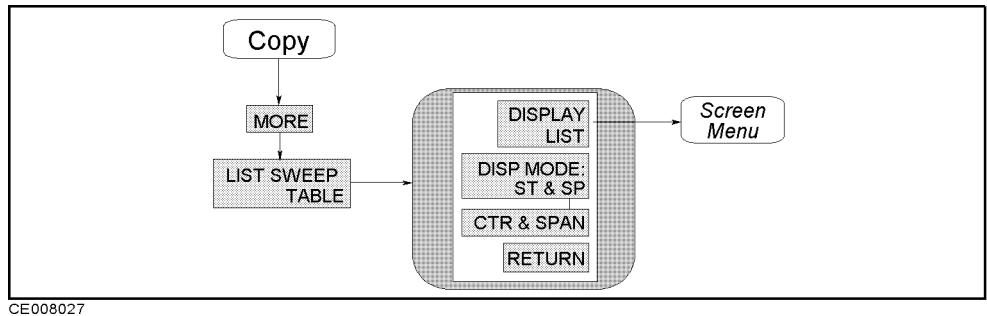

Figure 8-16. Copy List Sweep Menu

- **DISPLAY LIST** Displays the list sweep table and leads to the *Screen menu* to prepare for hard copy.
- **DISP MODE:ST & SP** Selects the start/stop format to list the sweep parameter.
- **CTR & SPAN** Selects the center/span format to list the sweep parameter.

Screen Menu

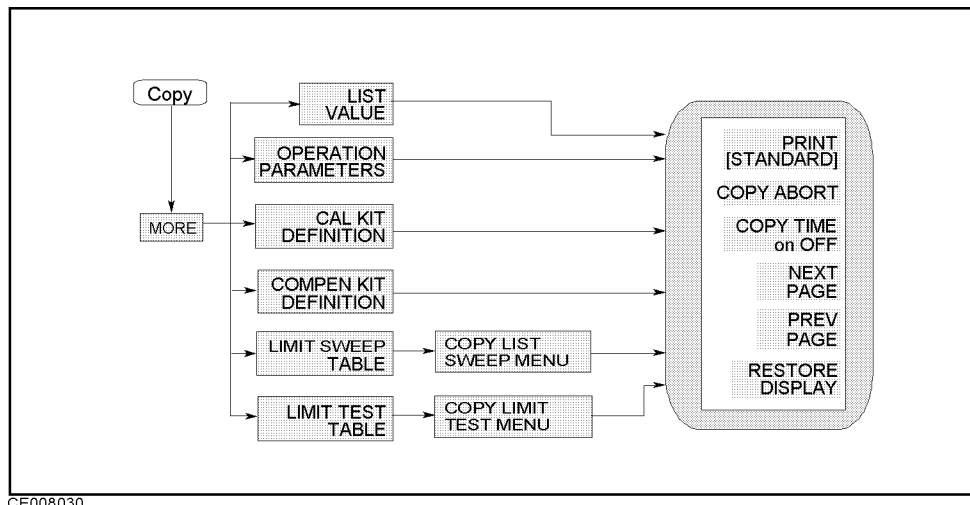
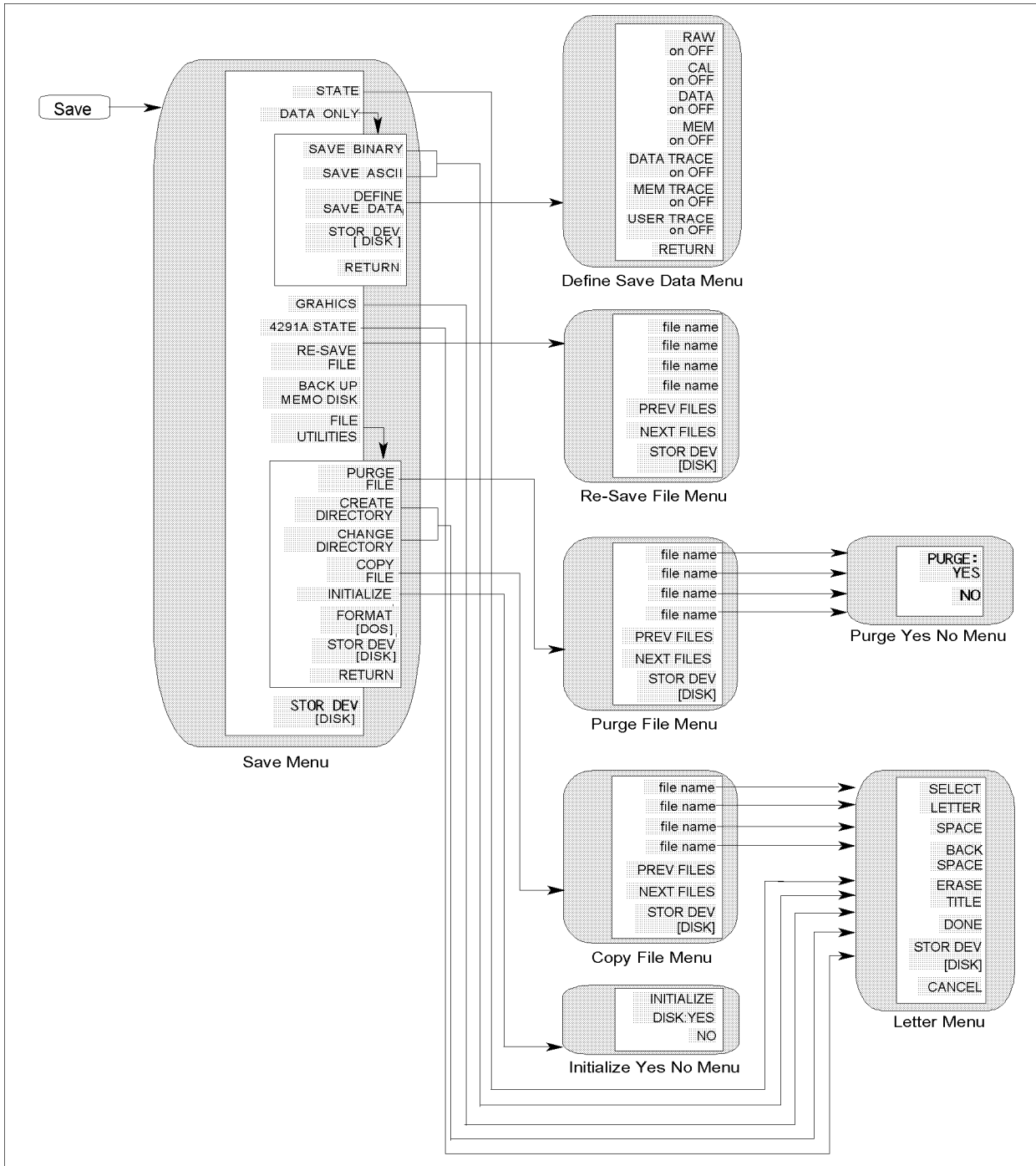

Figure 8-17. Screen Menu

- **PRINT [STANDARD]** Copies one page of the tabular listings to a compatible HP graphics printer. Either **STANDARD**, for a black and white printer, or **COLOR**, for a color printer, is shown in brackets (“ []”). This identifies which printer is selected as the default in the print setup menu. The default setting at power on is standard. Default text for a color printer is black.
- **COPY ABORT** Aborts a print in progress.
- **COPY TIME ON off** Turns printing time and date ON or OFF, time and date are printed first then the information displayed. See “Clock Menu” for setting the internal clock.
- **NEXT PAGE** Displays the next page of information in a tabular listing .
- **PREV PAGE** Displays the previous page of information in a tabular listing.
- **RESTORE DISPLAY** Turns off the tabular listing and returns the measurement display to the screen.

Save

Save



CE008039

Figure 8-18. Softkey Menus Accessed from the **Save** Keys

Recalling Instrument BASIC program

The **Save** and **Recall** keys do not access Instrument BASIC programs. Instrument BASIC has its own menus that are accessed from the keyboard. See the *Programming Manual* for more information.

Save Menu

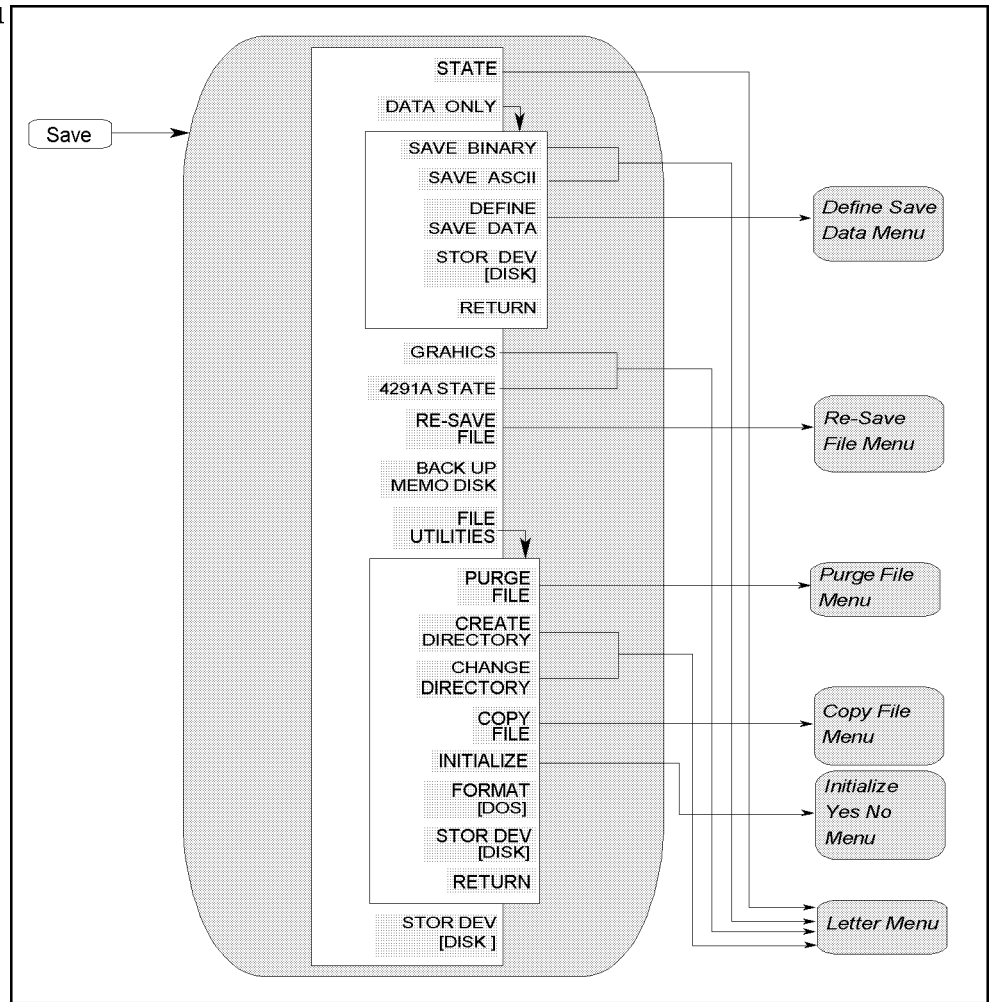

CE008029

Figure 8-19. Save Menu

- **STATE** Specifies saving the instrument states, the calibration coefficients and measurement data.
- **DATA ONLY** Displays the menu used to save data.

DATA ONLY does not save instrument settings such as start and stop frequencies. BE CAREFUL! Always make sure that you save the existing STATE if you want to use the setup again.

- **SAVE BINARY** Specifies saving the internal data arrays which are defined using the **DEFINE SAVE DATA** key.
- **SAVE ASCII** Specifies saving the internal data arrays as an ASCII file. The arrays saved are defined by the **DEFINE SAVE DATA** key.
- **DEFINE SAVE DATA** Displays the *define save data menu* that selects the applicable data arrays to be saved.

- **STOR DEV []** Selects between the floppy disk drive and the memory disk as the storage device. **[DISK]** shows the floppy disk is selected and **[MEMORY]** shows the memory disk is selected.
- **GRAPHICS** Specifies saving the graphics image on the screen as an TIFF file.
- **4291A STATE** Saves the instrument state and the internal data arrays in the format so that the 4291A can recall.

Note

Following settings are not saved.

Printing resolution (dpi)
 Sheet orientation
 Form feed
 Top margin
 Left margin
 Softkey label printing

- **RE-SAVE FILE** Displays the Re-save File menu used to update a file that is already saved.
- **BACK UP MEMO DISK** Backup the instrument state and the internal data arrays in the memory disk.
- **FILE UTILITIES** Displays the following softkeys:
 - PURGE FILE** Displays the Purge File menu used to remove a file saved on the disk.
 - CREATE DIRECTORY** Specifies creating a new directory in a DOS format disk. This function is not available for LIF files.
 - CHANGE DIRECTORY** Specifies changing the current directory of a DOS format disk. This function is not available for LIF files.
 - COPY FILE** Copies files. When a file is copied between the floppy disk and the memory disk, the disk formats of the disk and the memory disk must be same format.

Use the same disk format type for COPY FILE
--

When you copy files using this function, use the same disk format type for both the memory disk and the floppy disk. This copy function cannot copy files when the format of the memory disk is different from the format of the floppy disk.

INITIALIZE Displays the Initialize menu. A new disk must be initialized before data is stored on it. The disk can be formatted in either LIF or DOS format.

FORMAT [LIF] Toggles the disk format between the LIF and DOS formats that are used when initializing a new disk. This setting does not change even when the line power is cycled or the **[Preset]** key is pressed. The factory setting is LIF.

STOR DEV [] Selects between the floppy disk drive and the memory disk as the storage device. **[DISK]** shows the floppy disk is selected and **[MEMORY]** shows the memory disk is selected.

Save

Memory disk data is lost when the power is turned off

Use the floppy disk to store important data because the memory disk data is lost when the power is turned off.

The storage selection does not change even when the line power is cycled or the **Preset** key is pressed.

Define Save Data Menu

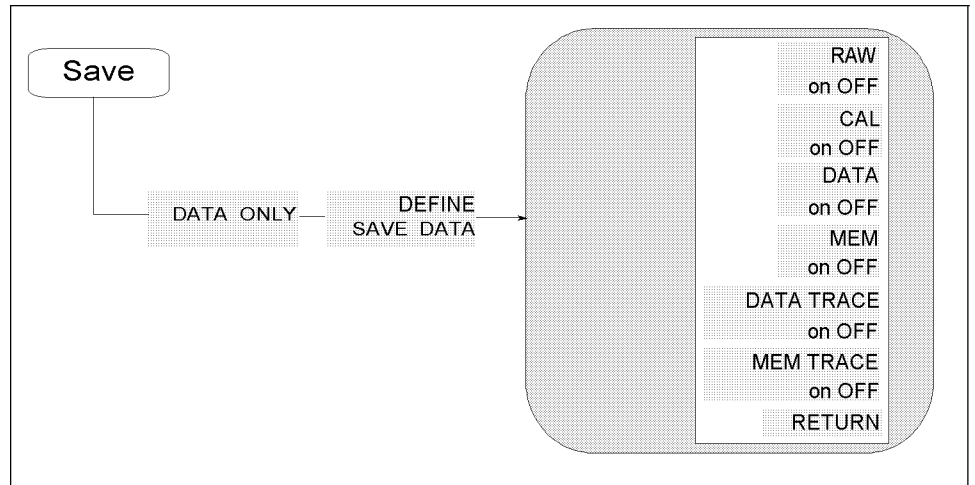

CE008019

Figure 8-20. Define Save Data Menu

- **RAW DATA ON off** Toggles saving or not saving the raw data arrays.
- **CAL ON off** Toggles saving or not saving the calibration coefficients arrays.
- **DATA ON off** Toggles saving or not saving the data arrays.
- **MEM ON off** Toggles saving or not saving the memory arrays.
- **DATA TRACE ON off** Toggles saving or not saving the trace arrays.
- **MEM TRACE ON off** Toggles saving or not saving the memory trace arrays.
- **USER TRACE ON off** Toggles saving or not saving the user trace arrays.

Save

Re-Save File Menu

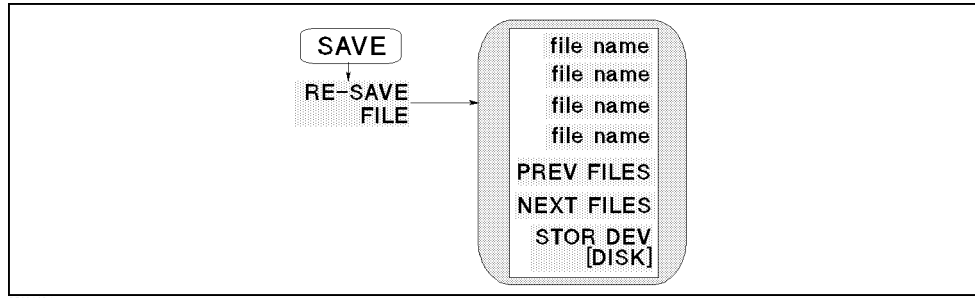

06008034

Figure 8-21. Re-Save File Menu

- **file name** Updates the file previously saved with the current instrument states or data. The data group to be saved is determined by the file name's extension. See "Saving and Recalling Instrument States and Data" later in this chapter for more details about file name extensions.
- **PREV FILES** Displays the previous file names in the softkey label to re-save data.
- **NEXT FILES** Displays the next file names in the softkey label to re-save data.
- **STOR DEV[]** Selects between the floppy disk drive and the memory disk as the storage device. **[DISK]** shows the floppy disk is selected and **[MEMORY]** shows the memory disk is selected. This setting does not change even when the line power is cycled or the **Preset** key is pressed.

Purge File Menu

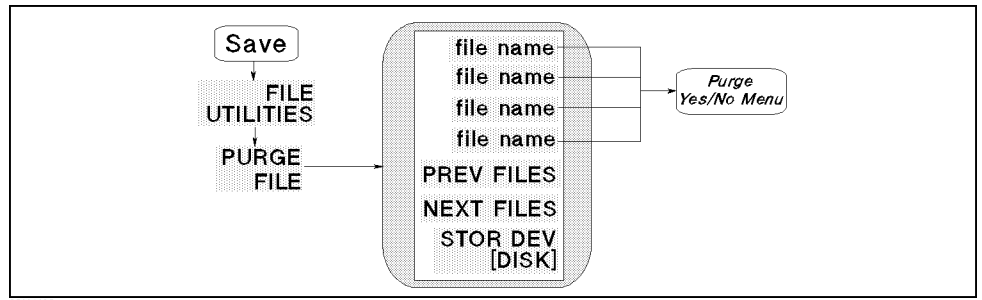

Figure 8-22. Purge File Menu

- **file name** Selects the file to be purged from the disk or the memory disk.
- **PREV FILES** Displays the previous file names in the softkey label to purge file.
- **NEXT FILES** Displays the next file names in the softkey label to purge file.
- **STOR DEV[]** Selects between the floppy disk drive and the memory disk as the storage device. **[DISK]** shows the floppy disk is selected and **[MEMORY]** shows the memory disk is selected. This setting does not change even when the line power is cycled or the **Preset** key is pressed.

Purge Yes No Menu

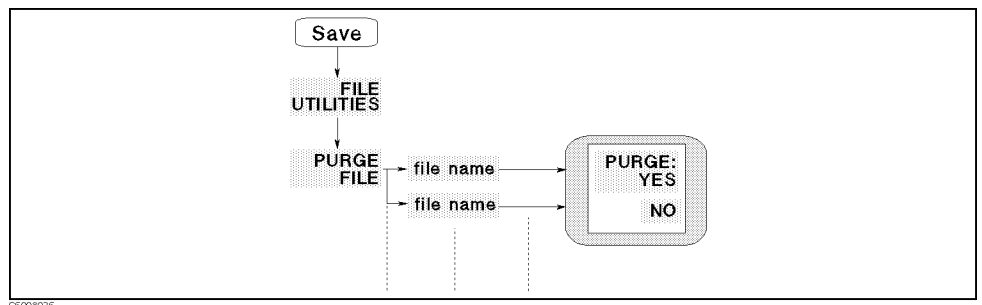

Figure 8-23. Purge Yes No Menu

- **PURGE: YES** Removes the file and returns to the previous menu.
- **NO** Returns to the previous menu without purging the file.

Save

Initialize Yes No Menu

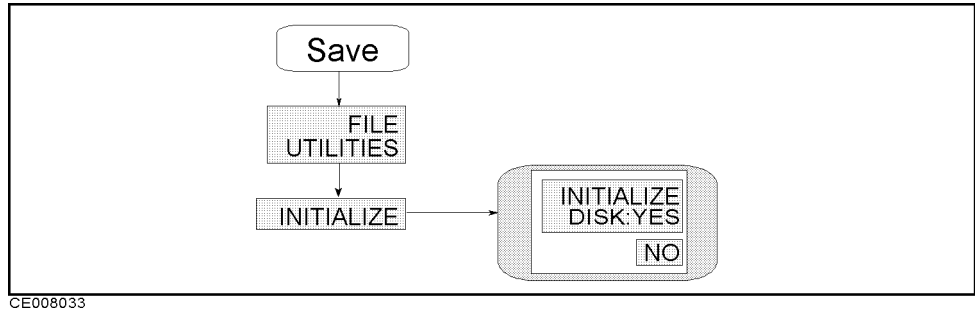

Figure 8-24. Initialize Yes No Menu

- **INITIALIZE DISK: YES** Initializes the disk or the memory disk. When the floppy disk is selected for initialization, **DISK** is displayed in the softkey label, When the memory disk is selected, **MEMORY** is displayed.
- **NO** Returns to the previous menu without initializing the floppy disk or the memory disk.

Recall Menu

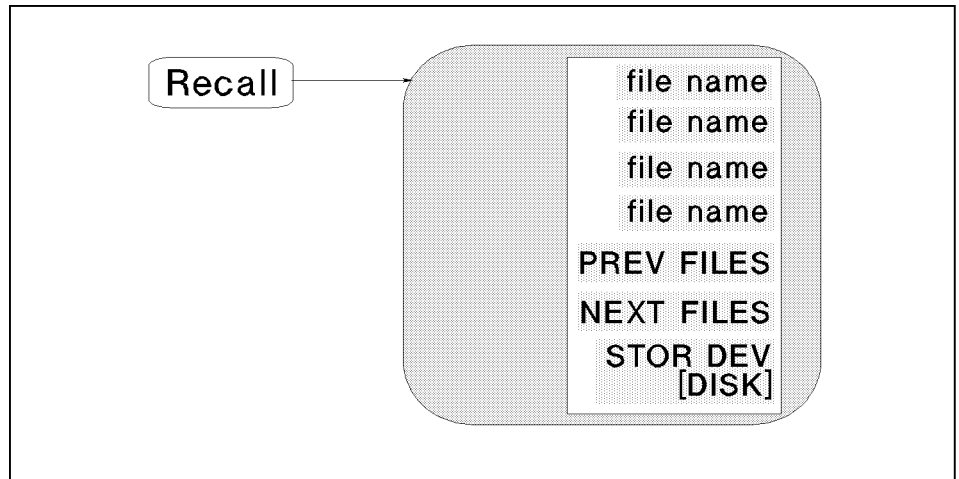

Figure 8-25. Recall Menu

- **file name** Selects a file to be loaded and loads the instrument state or data.
- **PREV FILES** Displays the previous set of file names used to load data.
- **NEXT FILES** Displays the next set of file names used to load data.
- **STOR DEV []** Selects between the floppy disk drive and the memory disk as the storage device. **[DISK]** shows the floppy disk is selected and **[MEMORY]** shows the memory disk is selected. This setting does not change even when the line power is cycled or the **Preset** key is pressed.

Auto Recall Function
When the analyzer is turned on, it looks for a file named "AUTOREC" from the floppy disk or the memory disk, and if found, the analyzer automatically reads the file to retrieve its data.

Limit Line Concept

These are lines drawn on the display to represent upper and lower limits or device specifications with which to compare the DUT. Limits are defined by specifying several segments, where each segment is a portion of the stimulus span. Each limit segment has an upper and a lower starting limit value.

Limits can be defined independently for the two channels with up to 18 segments for each channel (a total of 36 for both channels). These can be in any combination of the two limit types.

Limit testing compares the measured data with the defined limits, and provides pass or fail information for each measured data point. An out-of-limit test condition is indicated in the following ways:

- Displaying a FAIL message on the screen.
- Emitting a beep.
- Displaying an asterisk in tabular listings of data.
- Writing a bit into bit 3 and 4 of the instrument status register.

Limits are entered in tabular form. Limit lines and limit testing can be either ON or OFF while limits are defined. As new limits are entered, the tabular columns on the display are updated, and the limit lines (if on) are modified to the new definitions. The complete limit set can be offset in either stimulus or amplitude value.

How Limit Lines are Entered

Before limit lines can be explained, the concept of “segments” must be understood. A segment is the node of two limit lines. See Figure 8-26.

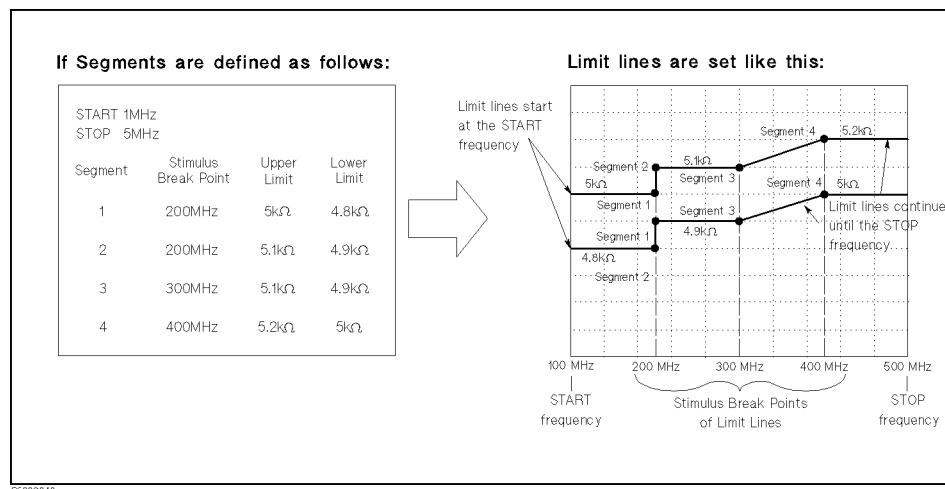

Figure 8-26. The Concept of Segments as a Point between Two Sets of Limit Lines

As you can see in Figure 8-26, segments are distinct points that define where limit lines begin or end. Limit lines span the distance between segments and represent the upper and lower test limits. Figure 8-26 shows another important aspect of limit lines. The far left hand side of a set of limit lines will continue from the minimum stimulus value

Limit Line Concept

(*START*) and the far right hand side of a set of limit lines will continue until the maximum stimulus value (*STOP*).

A segment is placed at a specific stimulus value (a single frequency for example). The first segment defines the limit line value from the minimum stimulus value. Once its stimulus value is entered, the upper and lower test limit (5 k Ω and 4.8 k Ω for example) need to be supplied.

Defining a second segment defines where the first set of limit lines ends. This process is repeated to create different sets of limit lines, each having new upper and lower limits. Up to 18 segments can be entered.

Limits can be defined independently for the two channels.

The example in Figure 8-26 shows a combination of limit lines that change instantly and gradually.

Segment 1 is at 200 MHz and has an upper and lower limit of 5 and 4.8 k Ω , respectively. Notice the upper and lower limit lines start at the *START* frequency (100 MHz) and end at segment 1.

Segment 2 is also at 200 MHz with different upper and lower limits of 5.1 k Ω and 4.9 k Ω , changing the limit values instantly.

Segment 3 is at 300 MHz with the same limit value as segment 2 to obtain a flat limit line.

Segment 4 is at 400 MHz with upper and lower limit values of 5.2 k Ω and 5 k Ω , changing the limit values gradually. Notice the upper and lower limit lines start at the segment and continue until the *STOP* frequency (500 MHz).

Limit lines cannot be cut
When limit lines are needed partially along the stimulus axis, the non-limit-testing portion must also be entered. Set the non-limit-testing portion by forcing the upper and lower limit values out of range (+1 G Ω and -1 G Ω for example).
Both an upper limit and a lower limit (or delta limits) must be defined.
If only one limit is required for a particular measurement, force the other limit out of range (+1 G or -1 G for example).

Turning Limit Lines and Limit Testing On and Off

Limit lines and limit testing features are *OFF* unless explicitly turned *ON* by the user. After entering the limit line information, you can turn *ON* the limit line feature and optionally the limit testing features. Turning these features *OFF* has no effect on the entered limit line information.

Limit Line Concept

Segment Entering Order

Generally, the segments do not have to be entered in any particular order. The analyzer automatically sorts them and lists them on the display in increasing order of stimulus value.

One exception is when two segments have the same stimulus value as described in Figure 8-26. If the same stimulus values exist, the analyzer draws the limit lines according to entered segment order. For example, in Figure 8-26, segment 1 should be entered in advance of segment 2.

Saving the Limit Line Table

Limit line information is lost if the LINE switch is turned off. However, the **(Save)** and **(Recall)** keys can save limit line information along with all other current analyzer settings. Limit line table information can be saved on a disk.

Offsetting the Stimulus or Amplitude of the Limit Lines

All limit line entries can be offset in either stimulus or amplitude values. The offset affects all segments simultaneously.

Supported Display Formats

Limit lines are displayed only in Cartesian format. In polar and Smith chart formats, limit testing of one value is available. The value tested depends on the marker mode and is the magnitude or the first value in a complex pair. The message "NO LIMIT LINES DISPLAYED" is shown on the display in polar and Smith formats.

Use a Sufficient Number of Points or Errors May Occur

Limits are checked only at the actual measured data points. If you do not select a sufficient number of points, it is possible for a device to be out of specification without a limit test failure indication.

To avoid this, be sure to specify a high enough number of points. In addition, if specific stimulus points must be checked, use the list sweep features described in "**(Sweep)**" in Chapter 6 so that the actual measured data points are checked.

Displaying or Printing Limit Test Data

The "list values" feature in the copy menu prints or displays a table with each measured stimulus value. The table includes limit line and limit test information (if these functions are turned on). If limit testing is ON, an asterisk "*" is listed next to any measured value that is out of limits.

If the limit lines are ON, and other listed data allows sufficient space, the following information is also displayed:

- Upper limit and lower limit
- The margin by which the device passes or fails the nearest limit

For more information about the list values feature, see “Copy Menu”.

Results of Printing the Display with Limit Lines ON

If limit lines are on, they are shown when you print the display. If limit testing is ON, the PASS or FAIL message is included as well.

Note



An example of a measurement using limit lines and limit testing is provided in the *Quick Start Guide*.

A sample program performing a limit test using GPIB commands is provided in the *Programming Manual*.

GPIB

What is GPIB?

The analyzer is factory-equipped with a remote programming digital interface using the GPIB. This allows the analyzer to be controlled by an external computer that sends commands or instructions to and receives data from the analyzer using the GPIB. In this way, a remote operator has the same control of the instrument available to a local operator from the front panel, except for the line power switch.

In addition, the analyzer itself can use GPIB to directly control compatible peripherals, without the use of an external controller. It can output measurement results directly to a compatible printer or plotter.

This section provides an overview of GPIB operation. The *Quick Start Guide* provides information on how to use the analyzer to control peripherals. It also explains how to use the analyzer as a controller to print and plot.

More complete information on programming the analyzer remotely over GPIB is provided in *Programming Manual*. The *Programming Manual* includes examples of remote measurements using an HP Vectra PC with BASIC programming. The *Programming Manual* assumes familiarity with front panel operation of the instrument. For more information on the IEEE 488.1 and 488.2 standard, see *IEEE Standard Digital Interface for Programmable Instrumentation*, published by the Institute of Electrical and Electronics Engineers, Inc., 345 East 47th Street, New York 10017, USA.

How GPIB Works

The GPIB uses a party-line bus structure in which up to 15 devices can be connected on one contiguous bus. The interface consists of 16 signal lines and 6 grounded lines in a shielded cable. With this cabling system, many different types of devices including instruments, computers, plotters and printers can be connected in parallel.

Every GPIB device must be capable of performing one or more of the following interface functions:

Talker

A talker is a device capable of sending device-dependent data when addressed to talk. There can be only one active talker at any given time. Examples of this type of device are voltmeters, counters, and tape readers. The analyzer is a talker when it sends trace data or marker information over the bus.

Listener

A listener is a device capable of receiving device-dependent data when addressed to listen. There can be any number of active listeners at any given time. Examples of this type of device are printers, power supplies, and signal generators. The analyzer is a listener when it is controlled over the bus by a computer.

Controller

A controller is a device capable of managing the operation of the bus and addressing talkers and listeners. There can be only one active controller at any time. Examples of controllers include desktop computers and minicomputers. In a multiple-controller system, active control can be passed between controllers, but there can only be one *system controller* that acts as the master, and can regain active control at any time. The analyzer is an active controller when it plots or prints in the addressable mode. The analyzer is a system controller when it is in the system controller mode.

GPIB Requirements

■ **Number of Interconnected Devices**

15 maximum

■ **Interconnection Path/Maximum Cable Length**

20 meters maximum or 2 meters per device, whichever is less.

■ **Message Transfer Scheme**

Byte serial/bit parallel asynchronous data transfer using a 3-line handshake system.

■ **Data Rate**

Maximum of 1 megabyte per second over limited distances with tri-state drivers. Actual data rate depends on the transfer rate of the slowest device involved.

■ **Address Capability**

Primary addresses: 31 talk, 31 listen. A maximum of 1 active talker and 14 active listeners at one time.

■ **Multiple Controller Capability**

In systems with more than one controller, only one can be active at any given time. The active controller can pass control to another controller, but only one system controller is allowed.

Analyzer GPIB Capabilities

As defined by the IEEE 488.1 standard, the analyzer has the following capabilities:

- SH1 Full source handshake.
- AH1 Full acceptor handshake.
- T6 Basic talker, answers serial poll, unaddresses if MLA is issued. No talk-only mode.
- TE0 Does not have extended address of talker.
- L4 Basic listener, unaddresses if MTA is issued. No listen-only mode.
- LE0 Does not have extended address of listener.
- SR1 Complete service request (SRQ) capabilities.
- RL1 Complete remote/local capability including local lockout.
- PP0 Does not respond to parallel poll.
- DC1 Complete device clear.
- DT1 Responds to a group execute trigger.
- C1, C2, C3, C4 System controller capabilities in system controller mode.
- C11 Pass control capabilities in addressable mode.
- E2 Tri-state drivers.

GPIB Function

Bus Mode The analyzer uses a single-bus architecture. The single bus allows both the analyzer and the host controller to have complete access to the peripherals in the system.

Two different modes are possible, system controller and addressable.

System Controller

This mode allows the analyzer to control peripherals directly in a stand-alone environment (without an external controller). This mode can only be selected manually from the analyzer front panel. Use this mode for operation when no computer is connected to the analyzer.

Addressable

This is the traditional programming mode, in which the external computer is involved in all peripheral access operations. When the external controller is connected to the analyzer through GPIB (as shown in Figure 8-27), this mode allows the external controller to control the analyzer over GPIB in the talker mode in order to send data, and in the listener mode to receive commands.

Programming information for the addressable mode is provided in the *Programming Manual*.

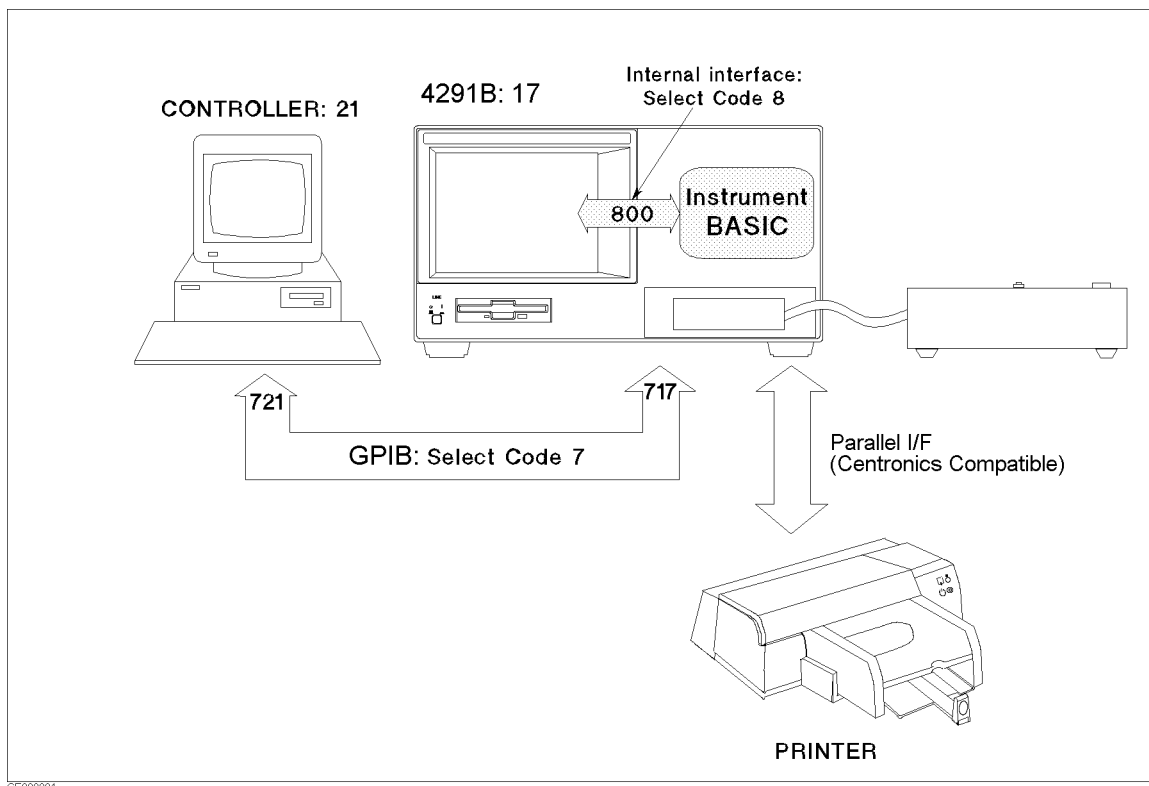

Figure 8-27. Analyzer Bus Concept

Setting Addresses

In GPIB communications, each instrument on the bus is identified by an GPIB address. This address code must be different for each instrument on the bus. See Appendix B for information on default addresses, and on setting and changing addresses. These addresses are not affected when you press **Preset** or cycle the power.

Saving and Recalling Instrument States and Data

Storage Devices The analyzer supports two storage devices, a floppy disk drive and a memory disk. The floppy disk drive is suited to storing large numbers of files and long term data storage. memory disk is suited to storing tentative data and instrument states and to store or get data quickly.

Disk Requirements

The analyzer's disk drive uses a 720 Kbyte or 1.44 Mbyte 3.5 inch floppy disk. See the "System accessories available" in Chapter 10 for disk part numbers.

Disk Formats

The analyzer's built-in disk drive can access both LIF (logical interchange format) and DOS formatted disks. The disk drive and the memory disk can also initialize a new disk in either LIF or DOS format.

The following list shows the applicable DOS formats for the analyzer:

- 1.44 Mbyte, 80 tracks, double-sided, 18 sectors/track

Memory disk Capacity

The memory disk capacity is 448 Kbyte. This capacity includes the directory area. The capacity of data area depends on the disk format type.

Copy Files Between the memory disk and the floppy Disk

A copy function is provided to copy files between the memory disk and the floppy disk. **FILE UTILITIES** in the SAVE menu displays the softkeys used to copy files. The GPIB command `MMEemory:COPY` is also available to copy files (See the *Programming Manual*). When the format of the memory disk is different from the format of the floppy disk, the copy function and the command can not be used.

File Types and Data Groups

File Types

The analyzer supports two file types, binary and ASCII, that are used to save data on a disk.

■ Binary File

Binary files are used to save measurement conditions and data using the SAVE function and to retrieve binary data using the RECALL function. External controllers and Instrument BASIC can read measurement data from binary data files.

■ ASCII file

ASCII measurement data or screen image files can be read by commonly available IBM PC based software for data analysis or other secondary functions. The RECALL function cannot read ASCII files.

Data Groups

■ Instrument States and Internal Data Arrays (STATE)

This group consists of the instrument states that include raw calibration coefficients, the data arrays, and the memory arrays. (Binary Files Only)

■ Internal Data Arrays (DATA ONLY)

The internal data arrays that are stored in the analyzer's memory consist of the following six data arrays. See "Data Processing" in Chapter 9 for complete information on each data array and their relationships.(Binary and ASCII Files)

- Calibration Coefficients arrays** contain the expanded calibration coefficients obtained by calibration and fixture compensation.
- Raw data arrays** contain the calibrated data obtained using the calibration coefficients.
- Data arrays** contain the compensated data obtained using the compensation coefficients.
- Memory arrays** contain the memory data arrays obtained using the DATA→MEM operation.
- Data-Trace arrays** contain the formatted data.
- Memory Trace arrays** contain the formatted data of the "memory arrays."

These arrays can be saved selectively to suit the application. For example, when measuring several devices with the same measurement settings, you may need to save only the *trace arrays* for each device. Saving only the necessary arrays reduces the disk space required and the disk access time. In addition, saving internal data also allows the analysis of the measurement results using an external controller. See "File Structure of Internal Data Arrays File for Binary Files" for more information.

Graphics Images (GRAPHICS)

- Graphics consist of the graphic images on the screen created using TIFF (Tagged Image File Format).

File Type and Data Group Combinations

You can select and save to a disk one of the following four combinations of the two file types and the four data groups.

■ Binary File

- Instrument states and internal data arrays (STATE)
- Internal data arrays (DATA ONLY binary)
- Graphics image (GRAPHICS)

■ ASCII File

- Internal data arrays (DATA ONLY ascii)

Saving and Recalling

File Names All data saved using the built-in disk drive and the memory disk has an identifying file name. A file name consists of the lower and upper case alphabet, numbers, and valid symbol characters. Up to 8 characters can be used for a file name. The following table shows the valid characters for LIF and DOS file names.

Valid Characters for File Names

Valid Characters for LIF	Valid Characters for DOS Format
A - Z (Upper case alphabet) ¹	A - Z (Upper case alphabet) ²
a - z (Lower case alphabet) ¹	a - z (Lower case alphabet) ²
0 - 9 (Numeric characters)	0 - 9 (Numeric characters)
_ (under line)	\$ & # % ' ! () - _ @ ^ { } ~ (Symbol)

1 LIF is case sensitive

2 DOS is not case sensitive

Suffixes (LIF) and Extensions (DOS)

One of the following suffixes or extensions is automatically added to the file name depending on the data group type stored in the file.

■ Suffixes for LIF

- _S : Instrument States and Internal Data Arrays (STATE)
- D : Internal Data Arrays (DATA ONLY (binary))
- I : Internal Data Arrays as an ASCII File (DATA ONLY (ASCII))
- T : Graphics Image as an TIFF File (GRAPHICS)

■ Extensions for DOS

- .STA : Instrument States and Internal Data Arrays (STATE)
- .DAT : Internal Data Arrays (DATA ONLY (binary))
- .TXT : Internal Data Arrays as an ASCII File (DATA ONLY (ASCII))
- .TIF : Graphics Image as an TIFF File (GRAPHICS)

Auto Recall Function

When the analyzer is turned on, it looks for a file named "AUTOREC" (from the floppy disk). If the file is found, the analyzer automatically uses the file to retrieve its data.

When both state and data files have been saved, the analyzer recalls only the state file.

File Structure of Internal Data Arrays File for Binary Files

When internal data arrays are saved as a binary file, the arrays' file consists of a file header at the top of the file and the data groups following the file header.

File Header

Every internal data array file begins with a file header. The following figure shows the header structure.

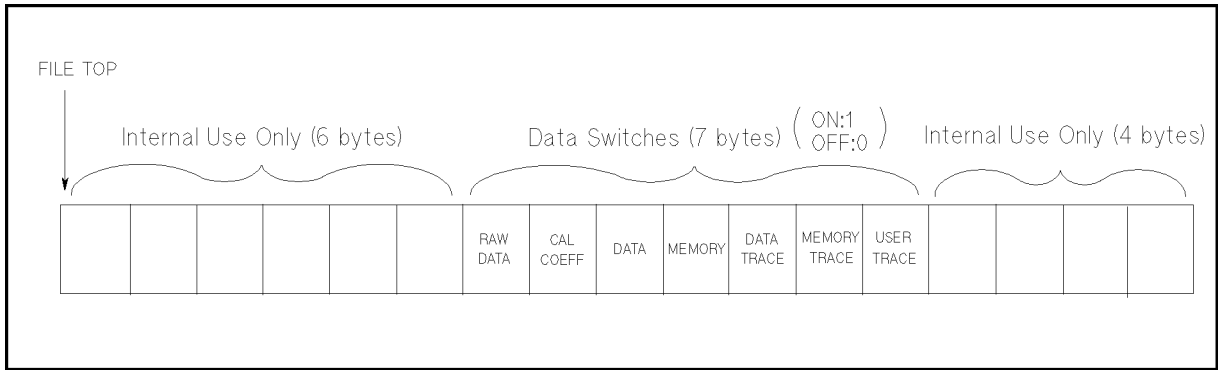

C6008003

Figure 8-28. File Header Structure

Seven data switches define the data group that follows the file head. Each one-byte switch is either 1 or 0 (decimal value) if the applicable data group exists or not, respectively. The data group to be followed is in the same order of these switches. For example, when the data switches, RAW DATA and DATA-TRACE are 1 (ON), while the others are OFF, only the RAW DATA and DATA-TRACE (in this order) groups will follow the header.

Saving and Recalling

Data Group

The data file structure of each channel begins with a header and consists of the same structured data segments. The number of data segments depends on the data group type as follows:

- **RAW DATA** consists of a header and four data segments per channel as shown in the following figure. They will follow the file header in this order:
- **DATA** consists of a header and a data segment by a channel.
- **DATA-TRACE** consists of a header and a data segment by a channel.

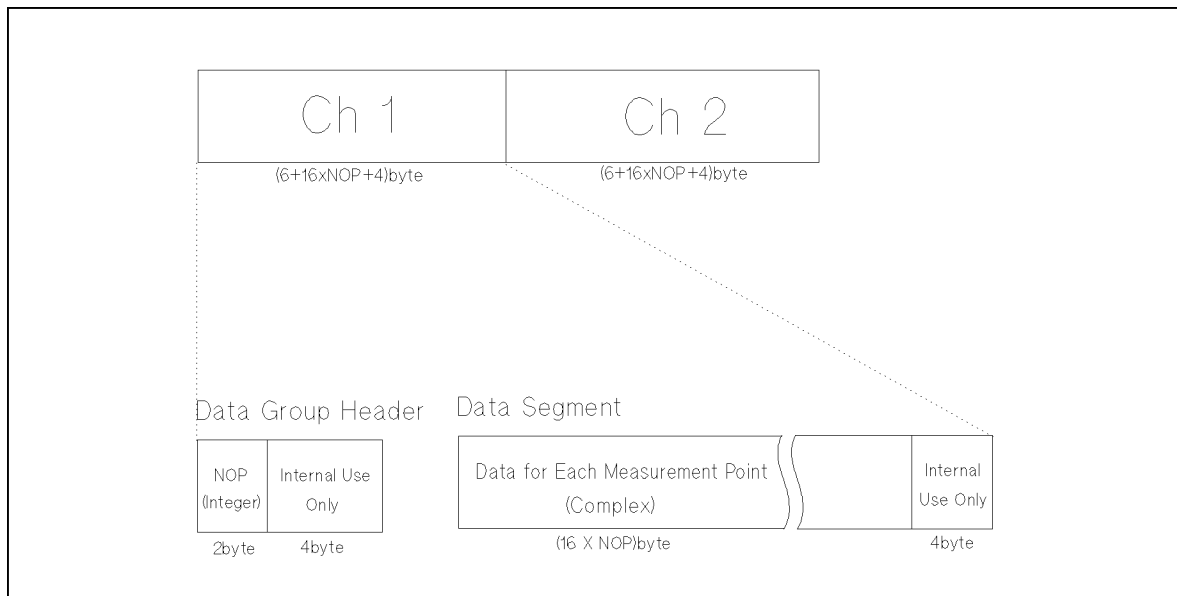

C6008004

Figure 8-29. RAW, DATA, and DATA-TRACE Data Group Structure

- **CAL** consists of data segments by a channel as shown in Figure 8-30. The first half of the segments are for channel 1 and the second half of the segments are for channel 2. The contents of each segment depend on the type of calibration performed. (See “**Cal**” in Chapter 5.)

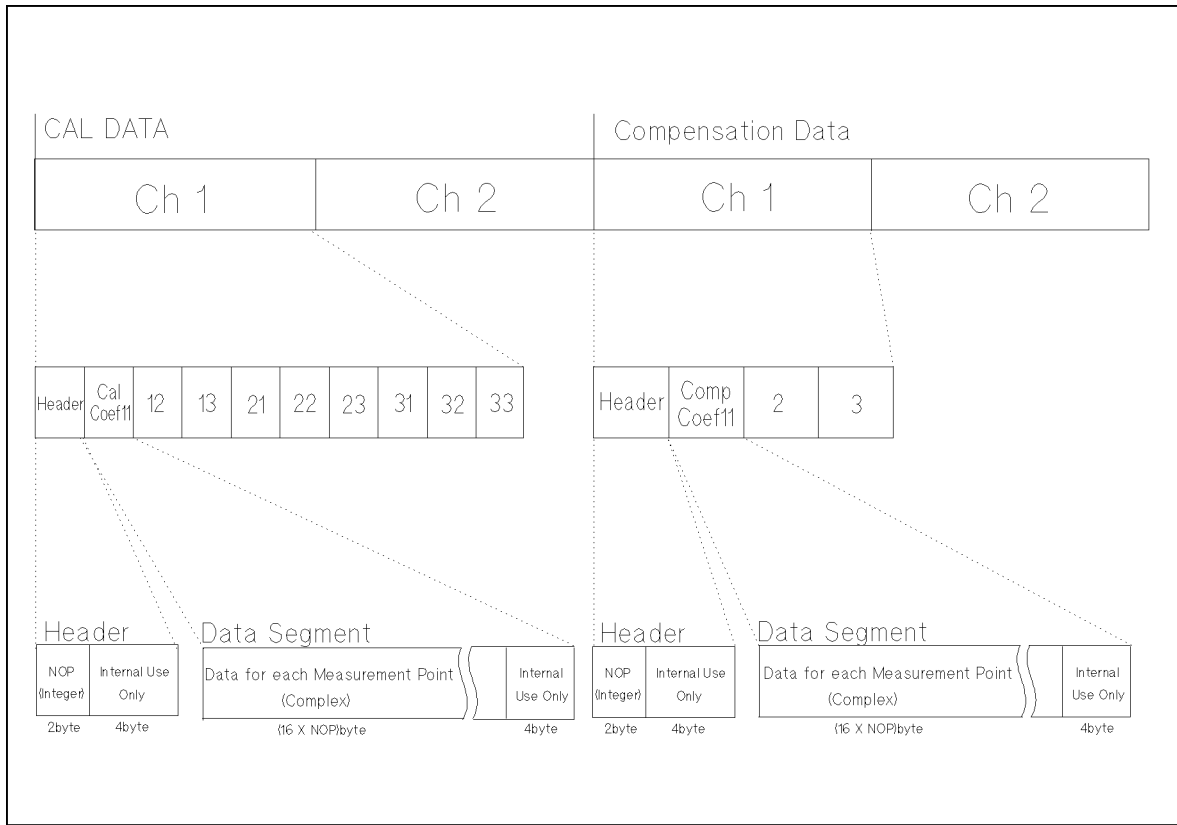

CG008005

Figure 8-30. CAL Data Group Structure

Number Of Points (NOP) is a two-byte INTEGER value. This number is equal to the number of complex data that follows the NOP.

DATA SEGMENT is a set of the values for each measurement point. The values are IEEE 754 double precision floating number. The values are two numbers (the first value is the real part, the second value is the imaginary part). The data size in bytes can be determined by $16 \times \text{NOP}$.

Saving and Recalling

- **MEMORY** consists of a header and a data segment by a channel.
- **MEMORY TRACE** consists of a header and a data segment by a channel.

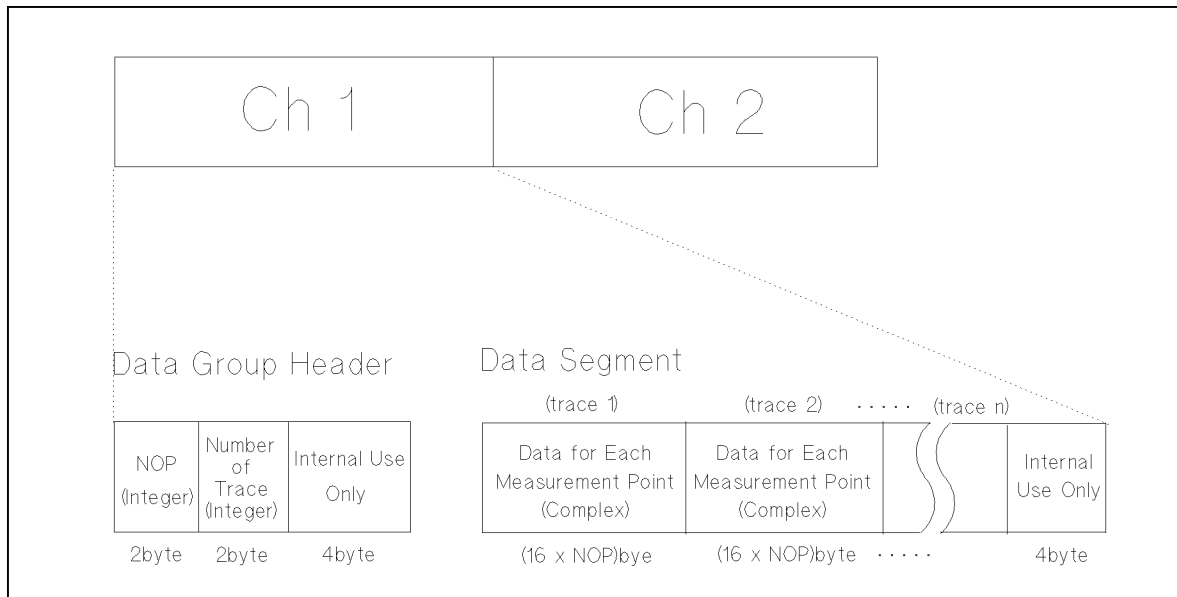

C6008009

Figure 8-31. MEMORY and MEMORY TRACE Data Group Structure

Number Of Points (NOP) of a memory trace is a two-byte INTEGER value.

DATA SEGMENT is a set of the values for each measurement point. The values are IEEE 754 double precision floating number. The values are two numbers (the first value is the real part, the second value is the imaginary part).

- **User Trace** consists of a header and 8 data segments that include user trace X-array and Y-array.

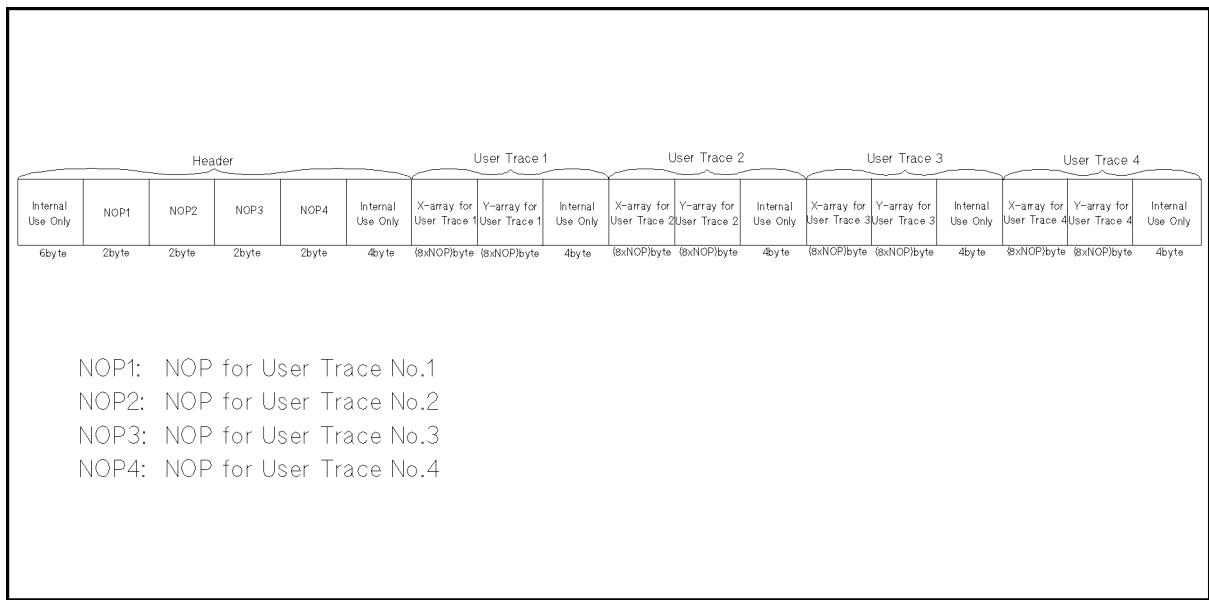

C6008007

Figure 8-32. User Trace Data Group Structure

- *Number Of Points (NOP)* is a two-byte integer value.
- The values of an X-array and Y-arrays are IEEE 754 double precision floating numbers (8 byte length). The data size in bytes for the X-array of each user trace can be determined by $8 \times \text{NOP}_n$ (n is the User Trace number).

Saving and Recalling

File Structure of Internal Data Arrays File for ASCII File

Numerical data and strings in an ASCII data file are separated by a tab, and a string is bound by double quotation marks. An ASCII data file consists of a status block and data blocks.

Status Block

The status block consists of two lines, the revision number and the date code.

Data Block

The data block consists of three parts, the state part, the title line, and the data part.

■ State

The state part consists of the following instrument states:

- Channel number
- Title on the screen
- Measurement parameter
- Number of points
- Sweep delay time
- Point delay time
- Sweep time
- Sweep type
- Point average
- Source power or CW frequency
- dc bias

■ Title

The title part consists of the data array names saved. Data array names are described in the next section.

■ Data

The data part consists of sweep parameter and numerical data of data arrays.

Table 8-2 shows an example of an ASCII data file.

Table 8-2. Contents of ASCII Files

Block Names		Contents
Status Block		"4291B REV1.00" "DATE: Dec 01 1997" ¹
Data Block	State	"CHANNEL: 1" "TITLE: This is a title." ² "MEASURE PARAMETER: IMPEDANCE MAG" "NUMBER of POINTS: 201" "SWEEP DELAY TIME: 62.5 us" "POINT DELAY TIME: 325 us" "SWEEP TYPE: LIST FREQ" "POINT AVERAGE: OFF" "OSC LEVEL: 500 mV" "DC BIAS: OFF" ³
	Title	"Frequency"→"Raw Real"→"Raw Imag"→... ^{4,5}
	Data ⁶	3.00000E+5→8.20007E-1→4.09729E-1→... ⁴ 1.52238E+7→9.32143E-1→-4.1914E-2→... : : :

- 1 This is the date when the file is saved.
- 2 This line is listed when the title is defined (displayed).
- 3 Shows the power level of the source for a frequency sweep. If power sweep is selected, the CW frequency is listed (for example "CW FREQ: 100 MHz").
- 4 "→" means tab code. Data is separated by the tab code.
- 5 This line lists the names of the data array saved in this file. Titles used in the ASCII files are shown in Table 8-3.
- 6 Each line lists the measurement data at each measurement point. The number of lines in the data block is the same as the number of points.

Saving and Recalling

File Structure for Single Channel and Dual Channel

If you save an ASCII file when DUAL CHANNEL is turned OFF, the ASCII data file consists of the active channel's data. If DUAL CHANNEL is turned ON, the ASCII data file consists of the data of both channels 1 and 2. The channel 2 data follows the channel 1 data as follows:

File Structures for Single and Dual Channels

Dual Channel OFF	Dual Channel ON
Status Block	Status Block
Data Block of Active Channel	Data Block of Channel 1
(end of file)	Status Block
	Data Block of Channel 2

Table 8-3. Data Groups and Data Array Names

Data Groups	Data Array Names		Descriptions
	Real Part	Imaginary Part	
Raw Data	Raw Real	Raw Imag	Raw data arrays.
Calibration Data	Cal[1-1] Real	Cal[1-1] Imag	Cal coefficient 11
	Cal[1-2] Real	Cal[1-2] Imag	Cal coefficient 12
	Cal[1-3] Real	Cal[1-3] Imag	Cal coefficient 13
	Cal[2-1] Real	Cal[2-1] Imag	Cal coefficient 21
	Cal[2-2] Real	Cal[2-2] Imag	Cal coefficient 22
	Cal[2-3] Real	Cal[2-3] Imag	Cal coefficient 23
	Cal[3-1] Real	Cal[3-1] Imag	Cal coefficient 31
	Cal[3-2] Real	Cal[3-2] Imag	Cal coefficient 32
	Cal[3-3] Real	Cal[3-3] Imag	Cal coefficient 33
Data	Data Real	Data Imag	Corrected Data arrays
Memory	Memory Real	Memory Imag	Corrected Memory arrays
Data-Trace	Meas Prmtr Data		Data-Trace arrays
Memory-Trace	Meas Prmtr Memory		Memory-Trace arrays

Analyzer Features

Introduction

This chapter provides additional information on analyzer features. The following subjects are covered in this chapter.

- System Overview
- Data Processing Flow

System Overview

Impedance analyzers usually apply a stimulus signal to the DUT. The analyzer then measures the complex voltage value (which is applied between the terminals of the DUT) and the complex current (which is flowing through the DUT). The impedance value is derived from both the voltage and current values.

Figure 9-1 is a simplified block diagram of the analyzer. A detailed block diagram of the analyzer is provided in the *Service Manual*, together with a complete theory of system operation.

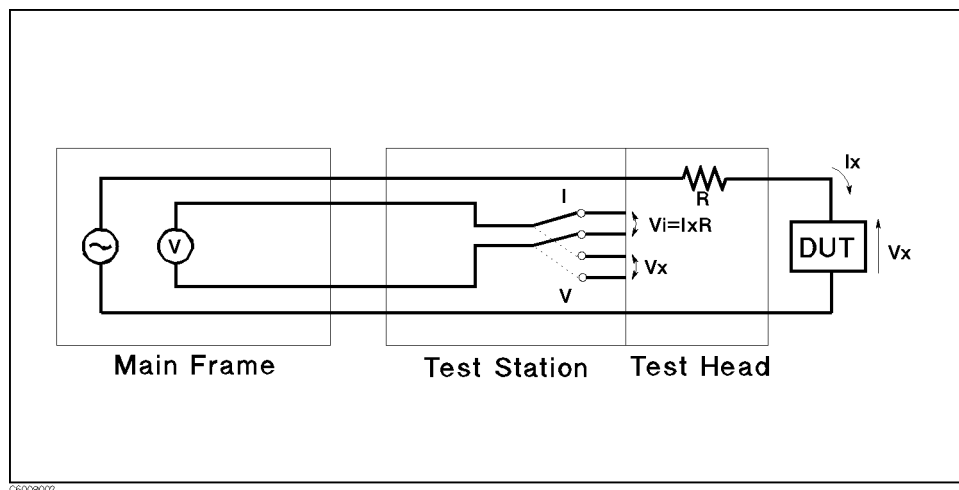

Figure 9-1. Analyzer Simplified Block Diagram

Data Processing

Overview The analyzer's receiver converts the input signal into useful measurement information. This conversion occurs in two main steps. First, the high frequency input signal is translated to fixed low frequency IF signals using analog mixing techniques. Second, the IF signals are converted into digital data by an analog-to-digital converter (ADC). From this point on, all further signal processing is performed mathematically by the analyzer microprocessor and digital signal processor. The following paragraphs describe the sequence of math operations and the resulting data arrays as the information flows from the ADC to the display. They provide a good foundation for understanding most of the measurement functions and the order in which they are performed.

Figure 9-2 is a data processing flow diagram that shows the flow of numerical data from the ADC to the display. The data passes through several math operations (shown as single-line boxes). Most of these operations can be selected and controlled by the front panel MEASUREMENT block menus. The data is also stored in data arrays (shown as double-line boxes). These arrays are places in the flow path where the data is accessible via GPIB or by using the floppy disk drive or the memory disk. Figure 9-2 also shows other data arrays (shown as double-dotted-line boxes). These arrays are not accessible via GPIB, but showing them may help you better understand the behavior of the instrument.

Note



While only a single flow path is shown, two identical paths are available that correspond to channel 1 and channel 2. When the channels are uncoupled, each channel can be independently controlled so that the data processing operations for one can be different from the other.

Data Processing Flow

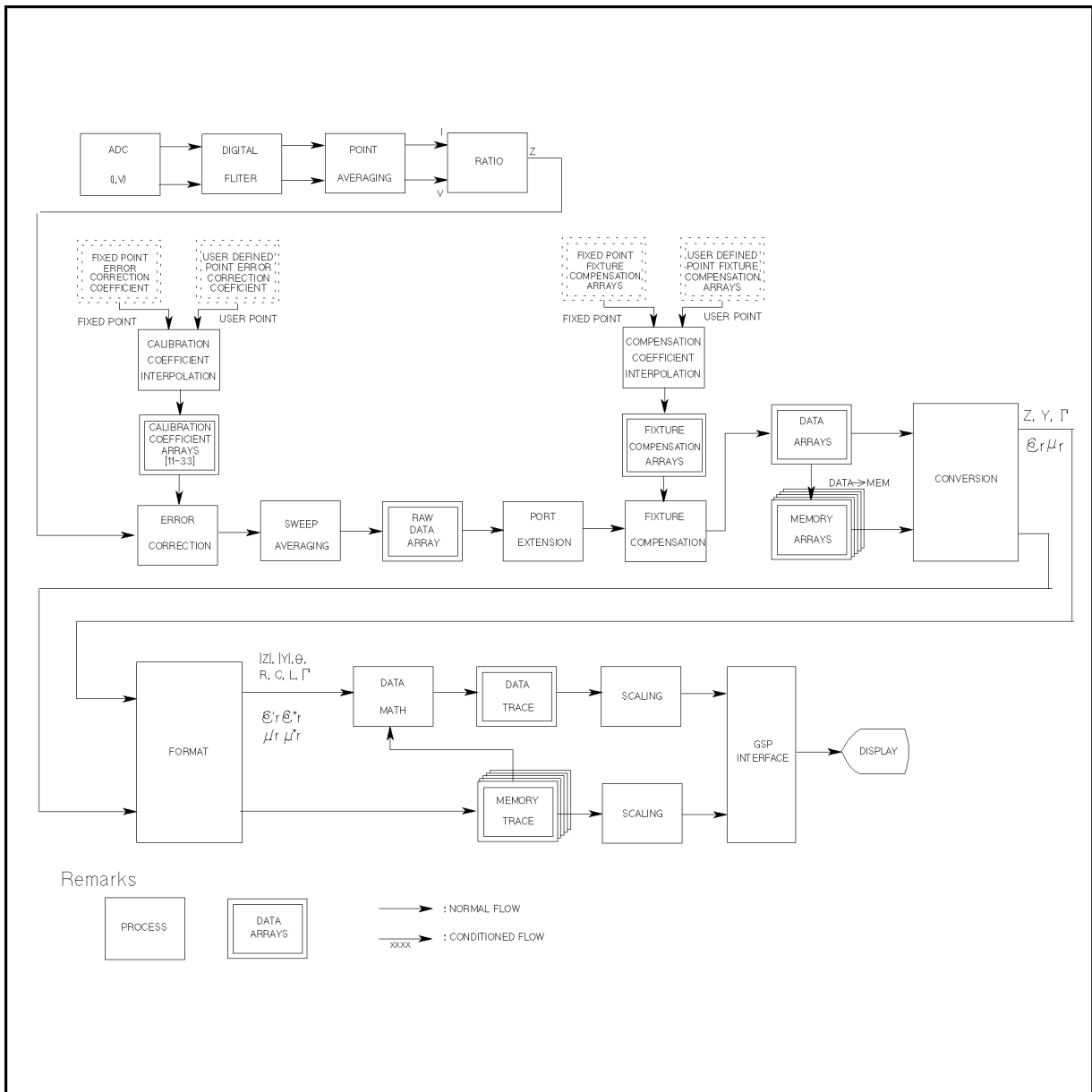

C6009001

Figure 9-2. Data Processing

AD converter (ADC)

The ADC converts an analog signal (which is already down-converted to a fixed low frequency IF) into digital data.

Digital Filter

The digital filter detects the IF signal by performing a discrete Fourier transform (DFT) on the digital data. The samples are converted into complex number pairs (real plus imaginary, $R+jX$) that represent both the magnitude and phase of the IF signal.

Ratio Processing

The ratio processing calculates the ratio of the current and voltage values (V/I) in order to convert them to an impedance value.

Fixed Point Calibration Coefficient Arrays and User Defined Point Calibration Coefficient Arrays

When a calibration measurement is performed, the coefficient values at each calibration measurement point are stored in these arrays. These arrays are not accessible via GPIB.

Calibration Coefficient Interpolation

When calibration measurements have been performed or stimulus settings have been changed, the calibration coefficients at the current measurement points are calculated from either the fixed point calibration coefficient arrays or the user defined point calibration coefficient arrays. When the current measurement point is different from the calibration measurement point, the coefficient value is interpolated from the fixed point calibration coefficient arrays or the user defined point calibration coefficient arrays.

Calibration Coefficient Arrays

Because the analyzer measures the three standards at three different OSC levels automatically when the calibration measurement is performed, calibration data arrays consist of nine arrays. These arrays are directly accessible via GPIB, or by using the floppy disk drive or the memory disk.

Error Collection

When a measurement calibration has been performed, error correction removes the repeatable systematic errors (stored in the calibration coefficient arrays) from the raw data arrays. See “**Cal**” in Chapter 5 and “Calibration Concepts” in Chapter 11 for details.

Averaging

This is one of the noise reduction techniques. Two types of averaging techniques are provided, sweep averaging and point averaging (the point averaging processes before the ratio processing). The sweep averaging calculation involves taking the complex exponential average of up to 999 consecutive sweeps. The point averaging calculation involves taking the complex average of up to 999 measurements on each measurement point. See “**Bw/Avg**” in Chapter 5.

Raw Data Arrays

These arrays store the results of all the preceding data processing operations. These arrays are directly accessible via GPIB, or using the floppy disk drive or the memory disk. Note that the numbers here are still complex pairs.

Port Extension

This is equivalent to “line-stretching” or artificially moving the measurement reference plane.

Fixture Compensation Coefficient Arrays

When a fixture compensation measurement has been performed and fixture compensation is turned on, the fixture compensation removes the repeatable systematic error. This error is caused by stray and residual impedance along the fixture used. This error information is stored in the fixture compensation arrays by the port extension process. See “**Cal**” in Chapter 5 and “Calibration Concepts” in Chapter 11 for details. When the permittivity measurement test fixture is selected, these arrays are not used. These arrays are directly accessible via GPIB, or by using the floppy disk drive or the memory disk.

Fixed Point Fixture Compensation Coefficient Arrays and User Defined Point Fixture Compensation Coefficient Arrays

When a compensation measurement is performed, the coefficient values at each compensation measurement point are stored in these arrays. These arrays are not accessible via GPIB.

Compensation Coefficient Interpolation

When compensation measurements have been performed, stimulus settings have been changed, or compensation is turned on, the compensation coefficient at the current measurement points is calculated from either the fixed point fixture compensation coefficient arrays or the user defined point fixture compensation coefficient arrays. When the current measurement point is different from the compensation measurement point, the coefficient value is interpolated from the fixed point fixture compensation coefficient arrays or user defined point fixture compensation coefficient arrays.

Fixture Compensation

When a fixture compensation measurement has been performed and this function is turned on, fixture compensation removes the errors caused by the test fixture. See “Fixture Compensation” in Chapter 11 for details.

Data Arrays

The results of error correction are stored in the data arrays as complex number pairs. These arrays are accessible via GPIB or by using the floppy disk drive or the memory disk.

Memory Arrays

If the data-to-memory operation is performed, the data arrays are copied into the memory arrays (data trace arrays are also copied into the memory trace array at same time). See “**Display**” in Chapter 5 in this chapter. These arrays are accessible using the floppy disk drive or the memory disk. These arrays are also output via GPIB, but data cannot be input into this array via GPIB.

Data Processing

If memory is displayed, the data from the memory arrays goes through the same data processing flow path as the data from the data arrays.

Format

This converts the complex number pairs into a scalar representation for display, according to the selected format. These formats are often easier to interpret than the complex number representation. (Polar, Smith, admittance chart, and complex plane formats are not affected by the scalar formatting.)

Data Math

This calculates the complex ratio of the two (data/memory), the difference (data–memory), summation (data+ memory), or multiplication (data×memory) when the data math function is selected. In addition, this function multiplies the ratio, or difference by a constant.

Data Trace Arrays

The results are stored in the data trace arrays. It is important to note those marker values and marker functions are all derived from the data trace arrays. Limit testing is also performed on this array. The data trace arrays are accessible via GPIB, or using the floppy disk drive or the memory disk.

Memory Trace Arrays

If the data-to-memory operation is performed, the data trace arrays are copied into the memory trace arrays (data arrays are also copied into the memory array at same time). These arrays are accessible using the floppy disk drive or the memory disk. These arrays are also output via GPIB, but data cannot be input into these arrays via GPIB.

Scaling

These operations prepare the formatted data for display on the LCD. This is where the appropriate reference line position, reference line value, and scale calculations are performed. See “Scale Ref” in Chapter 5 in this chapter.

Options and Accessories

Introduction

This chapter lists available options and accessories for the 4291B.

Options Available

Option 001 Add dc bias

This option adds the dc bias capability to the stimulus of 4291B. This option can be retrofitted using 4291V Option 001

Option 002 Add material measurement firmware

This option adds the material measurement capability to the 4291B. This option can be retrofitted using 4291V Option 002.

Option 011 Delete high impedance test head

This option deletes the high impedance test head.

Option 012 Add low impedance test head

This option adds the low impedance test head. This option can be retrofitted using 4291V Option 012.

Option 013 Add high temperature high impedance test head

This option adds the high high temperature high impedance test head. This option includes a fixture stand. This option can be retrofitted using 4291V Option 013.

Option 014 Add high temperature low impedance test head

This option adds the high temperature low impedance test head. This option includes a fixture stand. This option can be retrofitted using 4291V Option 014.

Options Available

Option 0BW Add Service Manual

This option adds the *4291B Service Manual*, which describes the performance test procedures and troubleshooting.

Option 1D5 Add high stability frequency reference

This option, a 10 MHz crystal in a temperature stabilized oven, improves the source signal frequency accuracy and stability. This option can be retrofitted using the 4291V Option 1D5.

Option 1A2 Keyboard less

This option is not furnished with the mini-DIN keyboard.

Option 1CM Rack mount kit

This option is a rack mount kit containing a pair of flanges and the necessary hardware to mount the instrument, with handles detached, in an equipment rack with 482.6 mm (19 inches) horizontal spacing.

Option 1CN Handle Kit

This option is a rack mount kit containing a pair of handles and the necessary hardware to mount the instrument.

Option 1CP Rack mount and handle kit

This option is a rack mount kit containing a pair of flanges, and the necessary hardware to mount the instrument with handles attached in an equipment rack with 482.6 mm (19 inches) horizontal spacing.

Measurement accessories available

16191A Side electrode SMD test fixture

The 16191A is used to measure a side electrodes surface mount device (SMD) with high repeatability. The usable operating frequency is up to 2 GHz.

16192A Parallel electrode SMD test fixture

The 16192A is used to measure a parallel electrodes surface mount device (SMD) with high repeatability. The usable operating frequency is up to 2 GHz.

16193A Small side electrode SMD test fixture

The 16193A is used to measure a small, side electrodes surface mount device (SMD) with high repeatability. The usable operating frequency is up to 2 GHz.

16194A High temperature component fixture

The 16194A is used to measure a component in wide temperature range. The operating temperature range is from -55°C through 200°C . The usable operating frequency is up to 2 GHz.

16453A Dielectric material test fixture

The 16453A is used to measure the permittivity of a dielectric material. This fixture has been designed to operate specifically with the 4291B equipped with the Option 002 (which provides the permittivity measurement function for dielectric material). The usable operating frequency is up to 1 GHz.

16454A magnetic material test fixture

The 16454A is used to measure the permeability of a toroidal core. This fixture has been designed to operate specifically with the 4291B equipped with the Option 002 (which provides the permeability measurement function for magnetic material). Two types of fixtures are included in the 16454A to provide flexibility for various material sizes.

16091A Coaxial termination fixture set

The 16091A is suited to the measurement of lead-less material samples or small size, axial lead components whose leads can be shortened. Two types of fixtures are included in the fixture set to provide flexibility for various sample sizes. The usable operating frequency is up to 1 GHz.

Accessories Available

16092A Spring clip test fixture

The 16092A provides a convenient capability for easily connecting and disconnecting samples. It has a usable operating frequency up to 500 MHz.

16093A/B Binding post test fixtures

The 16093A/B are suited for the measurement of relatively large size, axial and radial lead components or devices that do not fit other fixtures. The 16093A is provided with two small binding post measurement terminals set at 7 mm intervals. The usable frequency operating of the 16093A is up to 250 MHz. The 16093B employs a common type three binding post terminal arrangement that includes an extra guard post terminal. The terminal interval is 15 mm. The usable frequency operating of the 16093B is below 125 MHz.

16094A Probe test fixture

The 16094A provides probing capability for measuring circuit impedance and components mounted on circuit assemblies. The usable frequency operating of the 16094A is below 125 MHz.

System accessories available

System rack

The 85043B system rack is a 124 cm (49 inch) high metal cabinet designed to rack mount the analyzer in a system configuration. The rack is equipped with a large built-in work surface, a drawer for calibration kits and other hardware, a bookshelf for system manuals, and a locking rear door for secured access. Lightweight steel rails support the instrument along their entire depth. Heavy-duty casters make the cabinet easily movable even with the instruments in place. Screw-down lock feet permit leveling and semi-permanent installation. The cabinet is extremely stable when the lock feet are down. Power is supplied to the cabinet through a heavy-duty grounded primary power cable and to the individual instruments through special power cables included with the cabinet.

Printer

The 4291B is capable of printing displayed measurement results directly to a peripheral without the use of an external computer. The compatible printers for printing is:

Table 10-1. Supported Printers and Printing Modes

Printer	Monochrome Printing	Fixed Color Printing	Variable Color Printing
HP DeskJet 340J	✓	✓	
HP DeskJet 505	✓		
HP DeskJet 560C	✓	✓	
HP DeskJet 694C	✓	✓	
HP DeskJet 850C	✓	✓	
HP DeskJet 1200	✓	✓	✓
HP DeskJet 1600CM	✓	✓	✓

GPIB cable An GPIB cable is required to interface the analyzer with computer, or other external instrument. The following cables are available:

- 10833A (1 m)
- 10833B (2 m)
- 10833C (3 m)
- 10833D (0.5 m)

Service Accessories Available

Collet removing tool (Agilent part number 5060-0236)

This tool is used to remove the center conductor collet from an APC-7 connector. This is required in order to repair the collet, if the collect is damaged.

Collet removing tool guide (Agilent part number 04291-21002)

This tool is used with the collet removing tool when the collet of the low loss capacitor of the calibration kit is removed.

6-Slot collet (Agilent part number 85050-20001)

The repair part of the collet.

Impedance Measurement Basics

This chapter introduces the following basic concepts of impedance measurements:

- Impedance Parameters
- Series and Parallel Circuit Models
- Smith Chart
- Calibration Concepts
- Port Extension
- Fixture Compensation
- Permittivity Measurements
- Permeability Measurements

Impedance parameters

All circuit components, resistors, capacitors, or inductors, have parasitic components lurking in the shadows waiting for the unwary, for example unwanted resistance in capacitors, unwanted capacitance in inductors, and unwanted inductance in resistors. Thus, simple components should be modeled as complex impedances, for in fact that is what they are.

Impedance (\dot{Z})

Figure 11-1 (a) shows the complex impedance definitions and Figure 11-1 (b) shows the vector representation of complex impedance. Impedance, \dot{Z} is the total opposition that a circuit or device offers to the flow of alternating current at a given frequency. \dot{Z} contains a real and an imaginary part, and it is expressed in rectangular form as Resistance and Reactance, or in polar form as magnitude of Impedance and Phase as follows.

$$\dot{Z} = R + jX = |Z| \angle \theta \quad (11 - 1)$$

$$|Z| = \sqrt{R^2 + X^2} \quad (11 - 2)$$

$$\theta = \arctan \left(\frac{|X|}{R} \right) \quad (11 - 3)$$

$$R = R_s \quad (11 - 4)$$

Where,

\dot{Z} : Complex Impedance [Ω]

R : Resistance [Ω]

X : Reactance [Ω]

$|Z|$: Magnitude of Impedance [Ω]

θ : Phase of Impedance [deg or rad]

R_s : Series Resistance [Ω]

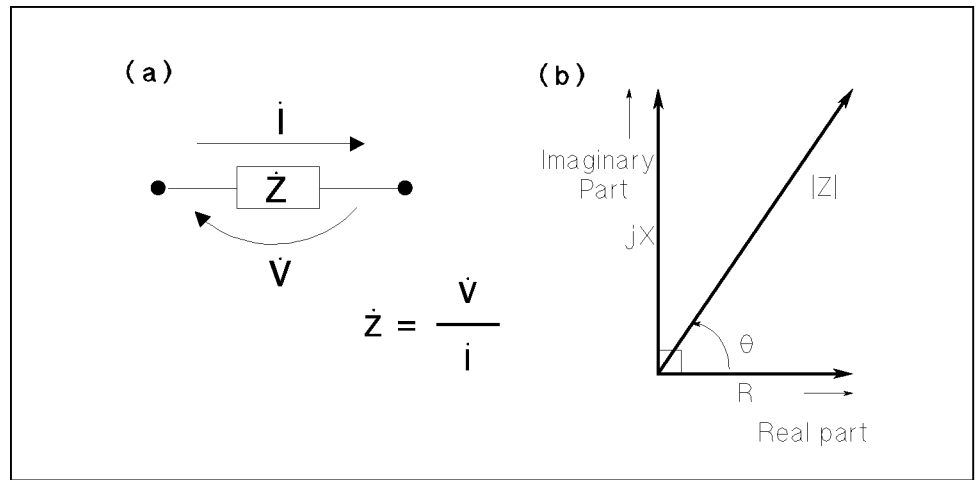

Figure 11-1. Definition of Impedance

The following parameters can be used to represent the reactance.

$$X = 2\pi fL \quad (11 - 5)$$

Impedance Parameter

Where,

f : Frequency [Hz]

L : Inductance [H]

In addition to these parameters, the Quality Factor (Q) and Dissipation Factor (D) are used to describe the quality of components.

$$Q = \frac{1}{D} = \frac{|X|}{R} \quad (11 - 6)$$

Where,

Q : Quality Factor

D : Dissipation Factor

Admittance (\dot{Y})

In some case, the dual of impedance (Admittance), \dot{Y} is used. Figure 11-2 shows the vector representation of admittance. As \dot{Z} (Complex Impedance), \dot{Y} is composed of a real and an imaginary part, and is expressed in rectangular form as Conductance and Susceptance, or in polar form as magnitude of Admittance and Phase. The following are expressions for Admittance.

$$\dot{Y} = \frac{1}{\dot{Z}} \quad (11 - 7)$$

$$\dot{Y} = G + jB = |Y| \angle \phi \quad (11 - 8)$$

$$|Y| = \sqrt{G^2 + B^2} = \frac{1}{|Z|} \quad (11 - 9)$$

$$\phi = \arctan\left(\frac{|B|}{G}\right) = -\theta \quad (11 - 10)$$

$$B = 2\pi fC \quad (11 - 11)$$

$$Q = \frac{1}{D} = \frac{|B|}{G} \quad (11 - 12)$$

$$G = \frac{1}{R_p} \quad (11 - 13)$$

Where,

\dot{Y} : Complex Admittance [S]

G : Conductance [S] (real)

B : Susceptance [S] (imaginary)

|Y| : Magnitude of Admittance [S]

ϕ : Phase of Admittance [deg or rad]

C : Capacitance [F]

R_p : Parallel Resistance [Ω]

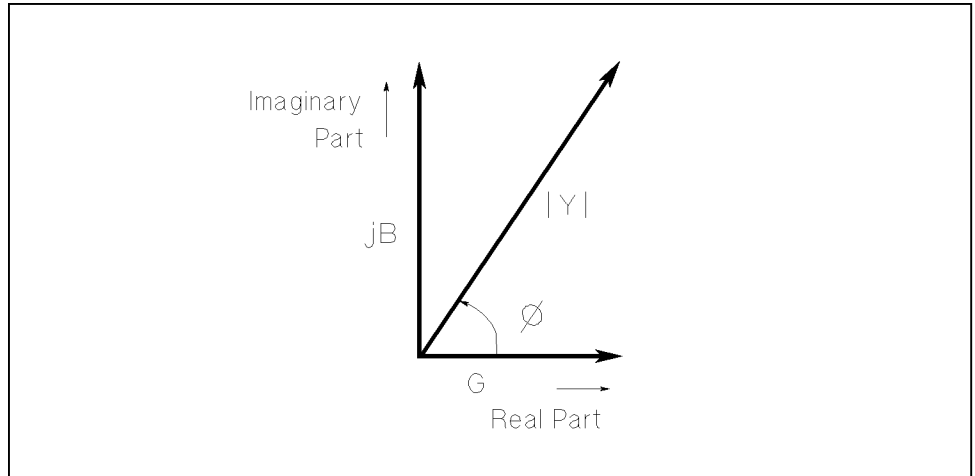

Figure 11-2. Vector Representation of Admittance

Reflection Coefficient ($\dot{\Gamma}$)

When measuring RF impedance, the reflection and/or transmission coefficient parameter values are usually measured by a network analyzer or RF impedance analyzer. The 4291B provides the reflection coefficient $\dot{\Gamma}$ as measurement parameter.

The reflection coefficient $\dot{\Gamma}$ is defined as:

$$\dot{\Gamma} = \frac{\dot{V}_{ref}}{\dot{V}_{inc}} = \Gamma_x + j\Gamma_y = |\dot{\Gamma}|(\cos\theta + j\sin\theta) = |\dot{\Gamma}| \angle \theta \quad (11 - 14)$$

where,

\dot{V}_{ref} is voltage of the reflected wave

\dot{V}_{inc} is voltage of the incident wave

The reflection coefficient value and the impedance value of the sample is interrelated, each with the other, by the following formulas:

$$\dot{\Gamma} = \frac{\dot{Z}_x - Z_0}{\dot{Z}_x + Z_0} \quad (11 - 15)$$

$$\dot{Z}_x = Z_0 \frac{1 + \dot{\Gamma}}{1 - \dot{\Gamma}} \quad (11 - 16)$$

where, Z_0 is characteristic impedance.

Series and Parallel Circuit Models

An impedance element can be represented by a simple equivalent circuit consisting of resistive and reactive elements (connected in series with or in parallel with each other). This representation is possible by either of the equivalent (series or parallel) circuits because both have identical impedances at the selected measurement frequency. These values are obtained by properly selecting the value of the equivalent circuit elements.

The 4291B can select the model by setting the measurement parameter (R, X, G, B, C_p , C_s , L_p , or L_s) using the **Meas** key. To determine which circuit model is best, consider the relative impedance magnitude of the reactance and R_s and R_p .

Table 11-1.
Parallel/Series Circuit Model and Measurement Parameter

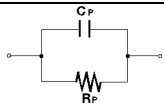
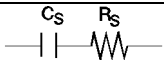
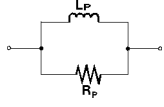
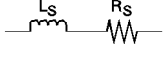
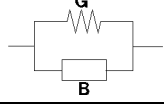
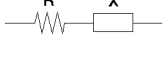
Parallel Circuit Model	Series Circuit Model
	
	
	

Parallel-Series Equivalent Circuit Conversion

Parameter values for a component measured in a parallel equivalent circuit and that measured in a series equivalent circuit are different from each other. The difference in measured values is related to the loss factor of the sample to be measured. If no series resistance or parallel conductance is present, the two equivalent circuits are identical.

However, the sample value measured in a parallel measurement circuit can be correlated with that of a series circuit by a simple conversion formula that considers the effect of the dissipation factor (D). See Table 11-2. The dissipation factor of a component always has the same value at a given frequency for both parallel and series equivalent circuits.

Table 11-2.
Dissipation Factor Equations and Parallel-Series
Equivalent Circuit Conversion

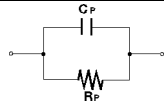
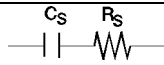
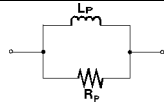
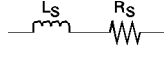
Device	Circuit Mode	Dissipation Factor	Conversion to other modes
C		$D = \frac{1}{2\pi f C_p R_p} = \frac{1}{Q}$	$C_s = (1 + D^2)C_p$ $R_s = \frac{D^2}{1 + D^2} R_p$
C		$D = 2\pi f C_s R_s = \frac{1}{Q}$	$C_p = \frac{1}{1 + D^2} C_s$ $R_p = \frac{1 + D^2}{D^2} R_s$
L		$D = \frac{2\pi f L_p}{R_p} = \frac{1}{Q}$	$L_s = \frac{1}{1 + D^2} L_p$ $R_s = \frac{D^2}{1 + D^2} R_p$
L		$D = \frac{R_s}{2\pi f L_s} = \frac{1}{Q}$	$L_p = (1 + D^2)L_s$ $R_p = \frac{1 + D^2}{D^2} R_s$

Selecting Circuit Mode of Capacitance

The following description gives some practical guide lines for selecting the capacitance measurement circuit mode.

Small Capacitance

Small capacitance yields a large reactance, that implies that the effect of the parallel resistance (R_p) has relatively more significance than that of the series resistance (R_s). The low value of resistance represented by R_s has negligible significance compared with the capacitive reactance, so the parallel circuit mode (C_p) should be used (see Figure 11-3).

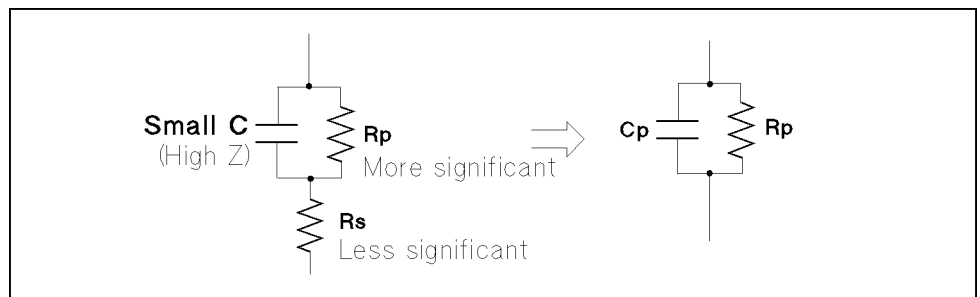

Figure 11-3. Small Capacitance Circuit Mode Selection

Series and Parallel Circuit Models

Large Capacitance

When the opposite is true and the measurement involves a large value of capacitance (low impedance), R_s has relatively more significance than R_p , so the series circuit mode (C_s -D or C_s -Q) should be used (see Figure 11-4).

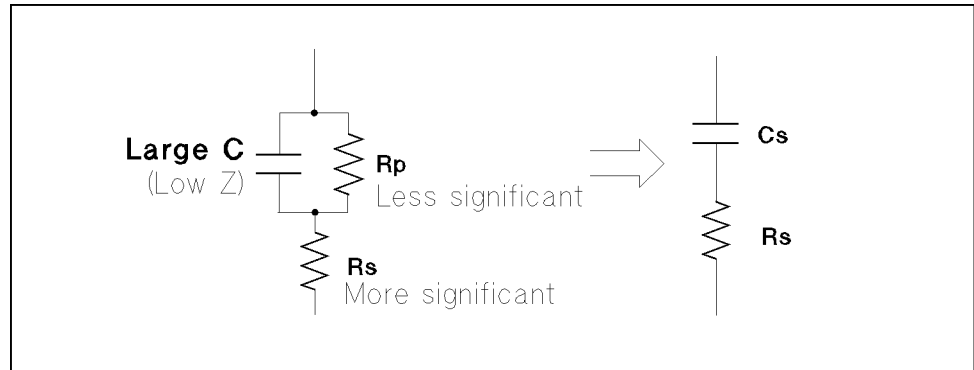

Figure 11-4. Large Capacitance Circuit Mode Selection

The following is a rule of thumb for selecting the circuit model according to the impedance of the capacitor:

- Above approx. 10 k Ω : Use parallel circuit model.
- Below approx. 10 Ω : Use series circuit model.
- Between above values: Follow the manufacturer's recommendation.

Selecting Circuit Mode of Inductance

The following description gives some practical guide lines for selecting the inductance measurement mode (that is, which circuit mode to use).

Large Inductance

The reactance at a given frequency is relatively large (compared with that of a small inductance), so the parallel resistance becomes more significant than the series component. Therefore, a measurement in the parallel equivalent circuit mode (L_p -D, L_p -Q or L_p -G) is more suitable (see Figure 11-5).

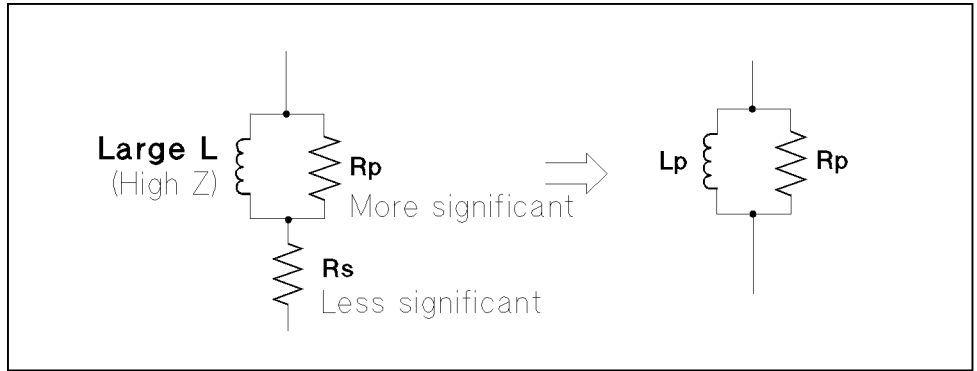

Figure 11-5. Large Inductance Circuit Mode Selection

Small Inductance

For low values of inductance, the reactance becomes relatively small (compared with that of a large inductance) so the series resistance component is more significant. Therefore, the series equivalent circuit mode (L_s -D or L_s -Q) is appropriate (see Figure 11-6).

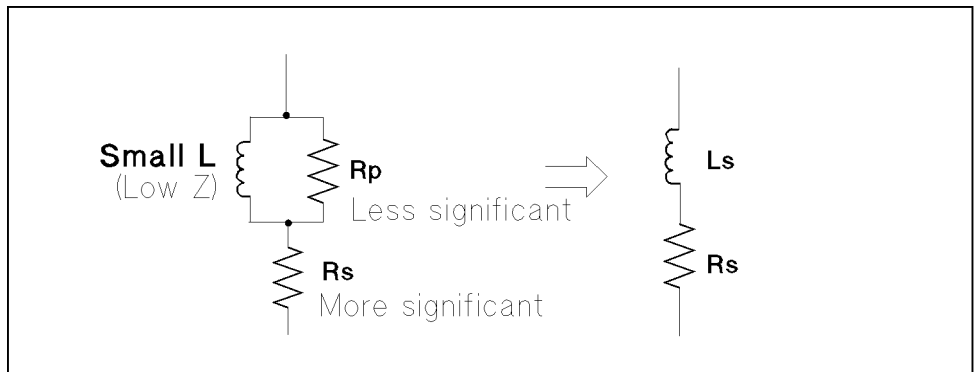

Figure 11-6. Small Inductance Circuit Mode Selection

The following is a rule of thumb for selecting the circuit model according to the impedance of the inductor:

- Below approx. 10 Ω : Use series circuit model.
- Above approx. 10 k Ω : Use parallel circuit model.
- Between above values: Follow the manufacturer's recommendation.

Smith Chart

This section provides a brief description of the Smith Chart for users who are not familiar with its use.

Figure 11-7 shows the Smith Chart plane of impedance coordinates. On the Smith Chart plane, the coordinate scales signify the impedance component quantities.

The circles tangent at point **a** are the scales for which the resistance values (R) are constant. The arcs that cross at point **a** and intersect the circles at right angles are the scales for which reactance values (X) are constant.

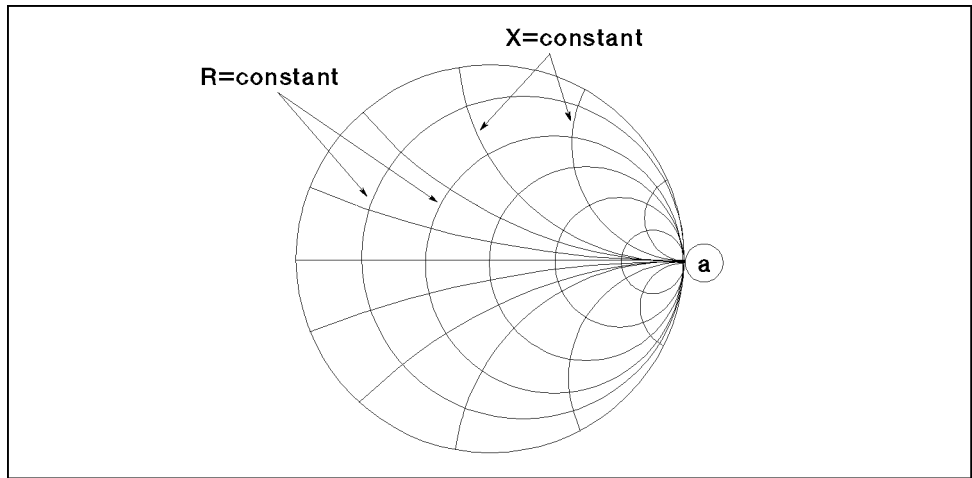
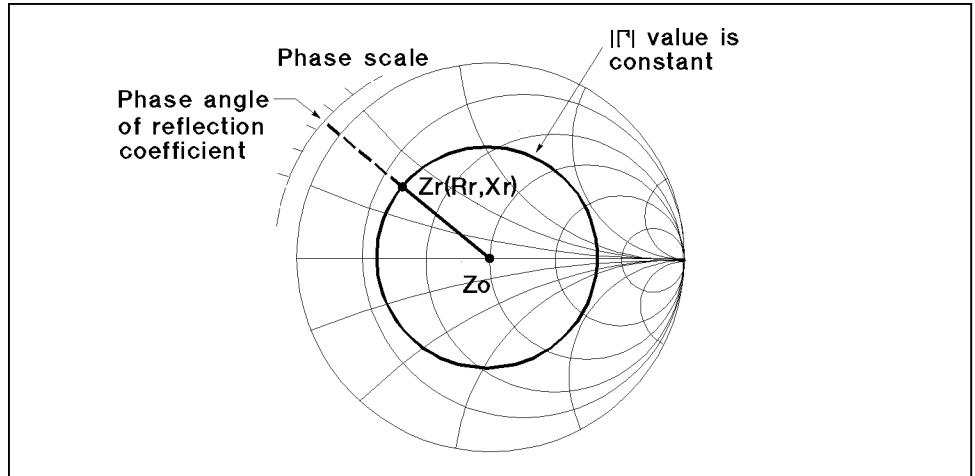

Figure 11-7. Smith Chart

These resistance and reactance scale values are the normalized values. They are calculated by dividing the sample impedance ($Z_x = R_x + jX_x$) by the characteristic impedance ($Z_0 = 50\Omega$) of the measuring circuit. Therefore, the normalized impedance $R_r + jX_r$ is :

$$R_r + jX_r = \frac{Z_x}{Z_0} = \frac{R_x}{50} + \frac{jX_x}{50} \tag{11 - 17}$$

A sample impedance value is represented on the Smith Chart as a point coordinated with the scales corresponding to its normalized impedance (see Figure 11-8). The base impedance Z_0 (characteristic impedance) is located at the center of the Smith Chart plane. The radius vector $Z_0 \cdot Z_r$ represents the reflection coefficient value $|\Gamma| \angle \theta$ of the sample (in this case, the electrical length of the transmission line is not being taken into consideration). The phase angle scales for the reflection coefficient vector are provided along the outer circumference of the Smith Chart. The phase angle of the reflection coefficient can be read from the phase angle scale as indicated by an extension of the vector $Z_0 \cdot Z_r$. The absolute value of the reflection coefficient $|\Gamma|$ is constant at any point on the circle of the radius $Z_0 \cdot Z_r$.



06011008

Figure 11-8. Impedance Read-out

When a coaxial cable of line length l is terminated by the sample and the cable is lossless, the impedance value of the sample measured at the other end of the line is derived as follows:

First, the difference in phase angle of the reflection coefficient value Γ (produced by the lead length l) is calculated using the following equation:

$$\theta = \frac{4\pi l}{\lambda} \tag{11 - 18}$$

Where, λ is the wavelength of test signal.

Next, the radius vector $Z_0 \cdot Z_x$ is rotated clockwise (towards the generator) by the calculated phase angle θ . The measured impedance value (normalized impedance) coincides with the scale reading at point Z_m (see Figure 11-9).

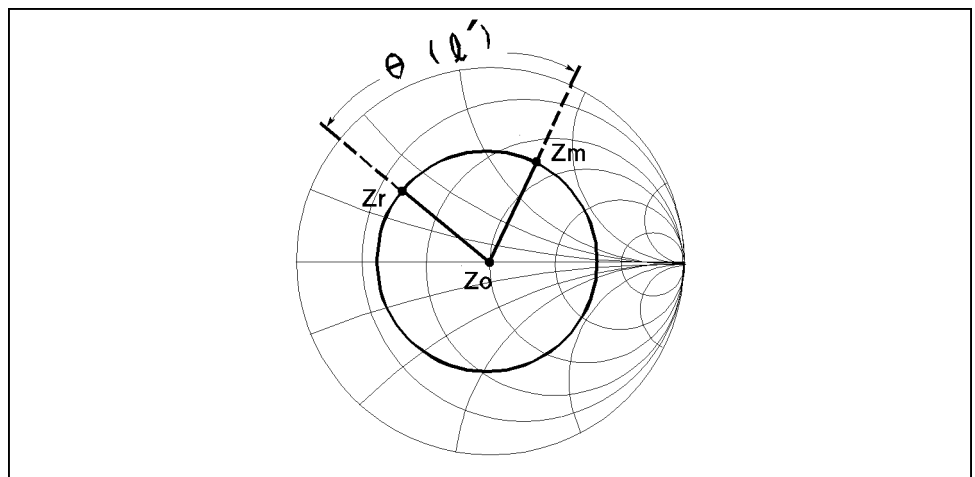

06011009

Figure 11-9. Phase Shift by Transmission Line

Calibration Concepts

This section describes the basic concepts of OPEN SHORT LOAD calibration and Low-Loss air-capacitor calibration. The Low-Loss air-capacitor calibration improves the accuracy of the phase measurements.

OPEN SHORT LOAD Calibration

Ideal Measurement Circuit

Figure 11-10 (a) shows the basic measurement circuits for the I-V method. This method uses two vector voltmeters V_v and V_i (V_v detects the vector voltage applied to the DUT and V_i detects the vector current flowing through the DUT). Assuming that the measurement circuit is ideal (which means there is no stray admittance and no residual impedance), and the impedance values of all the components in the measurement circuit are exactly correct, the DUT's impedance value \dot{Z}_x is calculated using the following equations:

$$\dot{Z}_x = R \frac{\dot{V}_v}{\dot{V}_i} \quad (11 - 19)$$

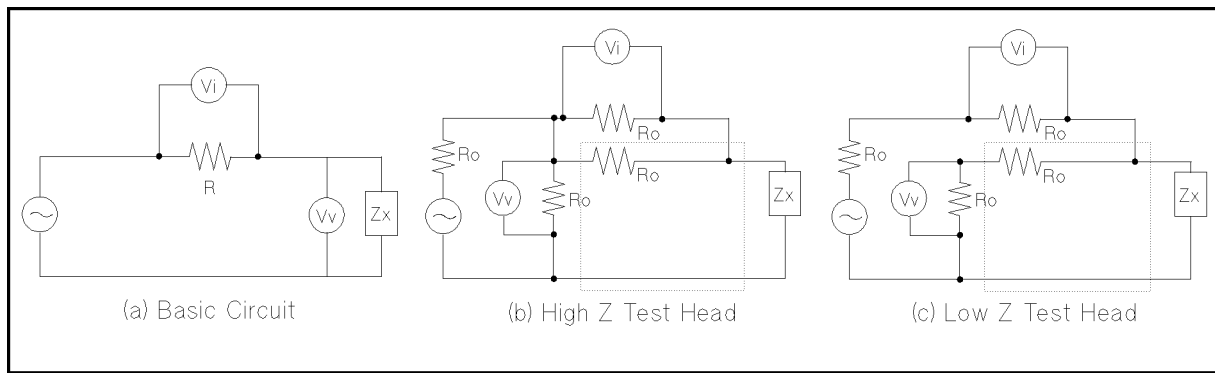

Figure 11-10. Measurement Circuits for I-V Method

Figure 11-10 (b) and (c) show the simplified measurement circuits of the high impedance test head and the low impedance test head of the analyzer. The DUT's impedance value (\dot{Z}_x) is calculated using the following equations (if the measurement circuit is ideal):

For the high impedance test head (Figure 11-10-(b)), \dot{Z}_x is :

$$\dot{Z}_x = \frac{R_0}{2} \left(\frac{\dot{V}_v}{\dot{V}_i} - 1 \right) \quad (11 - 20)$$

For the low impedance test head (Figure 11-10-(c)), \dot{Z}_x is :

$$\dot{Z}_x = \frac{2R_0}{\frac{\dot{V}_i}{\dot{V}_v} - 1} \quad (11 - 21)$$

General Impedance Measurement Schematic

However, actual measurement circuits have some error terms (such as stray admittance and residual impedance) plus, the components of the circuit also have some errors. In addition, the four resistances (R_0) in the measurement circuit do not have exactly the same impedance value. In fact, the impedance values calculated from the above equations do not correspond with the actual impedance value of the DUT. Generally, an impedance measurement circuit using two vector voltmeters is represented as shown in Figure 11-11.

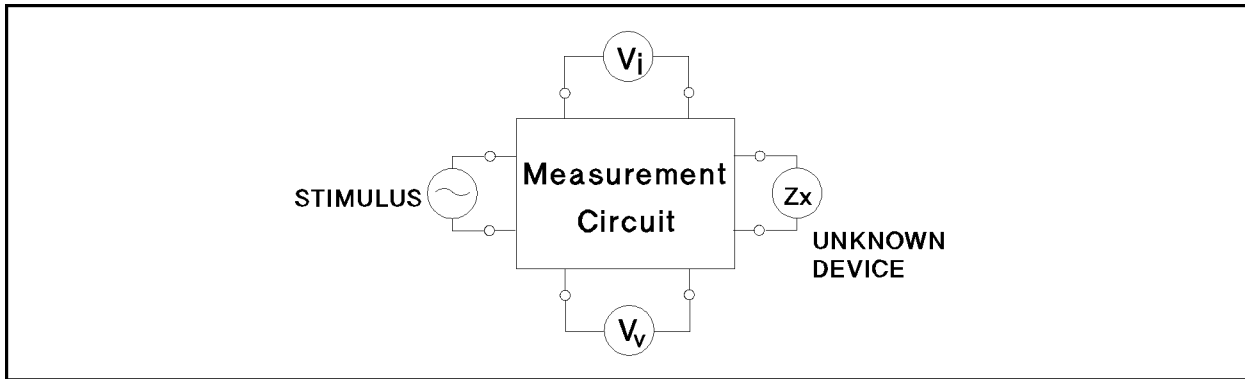

Figure 11-11. General Schematic for Impedance Measurement Using Two Vector Voltmeters

This general impedance measurement circuit uses two vector voltmeters. These two voltmeters can measure at any two different points in a linear circuit. In this case, the DUT's impedance can be expressed by the measured voltage values (\dot{V}_v and \dot{V}_i) using a bilinear form as follows:

$$\dot{Z}_x = \dot{a} \frac{1 + \dot{b}\dot{r}}{1 + \dot{c}\dot{r}} \tag{11 - 22}$$

Where,

\dot{a} , \dot{b} , \dot{c} are complex constants

\dot{r} is a ratio between \dot{V}_v and \dot{V}_i as follows:

$$\dot{r} = \frac{\dot{V}_v}{\dot{V}_i} \tag{11 - 23}$$

In general, \dot{Z}_x can be expressed using the above bilinear form whenever the measurement circuit is linear.

By using the measurement impedance value (\dot{Z}_m) instead of the voltage ratio \dot{r} and modifying the equation, \dot{Z}_x can also be expressed using the following bilinear form:

$$\dot{Z}_x = \dot{A} \frac{\dot{Z}_m - \dot{B}}{1 - \dot{C}\dot{Z}_m} \tag{11 - 24}$$

Where, \dot{A} , \dot{B} , and \dot{C} are complex constants (calibration coefficients) related to the circuit.

If three standards that have known impedance value are measured, these three constants can be calculated. The analyzer uses the

Calibration Concepts

OPEN, SHORT, and LOAD standards (furnished) for the calibration. Once these constants are known, any impedance of the DUT can be calculated from the measured impedance value.

Where, \hat{B} represents residual impedance when the circuit is perfectly shorted and \hat{C} represents stray admittance when the circuit is perfectly open.

Low Loss Capacitor Calibration

Accurate Q measurements require good analyzer stability and correct markings on the phase scale of the analyzer. In particular, high Q (or low D : dissipation factor) measurements at high frequencies require high accuracy for phase measurements.

The phase accuracy of the analyzer is determined entirely by the OPEN SHORT LOAD calibration. But, it is not guaranteed that the phase uncertainty for a 50 Ω LOAD at high frequencies is lower than the uncertainty requirement for a high Q measurement.

For example, if you want to measure the Q factor with 10% of uncertainty for a DUT whose Q value is almost 100, the uncertainty for phase scaling must be less than 10^{-3} . But, it is difficult to ensure that the phase uncertainty for the 50 Ω LOAD is less than 10^{-3} at high frequencies.

To reduce the uncertainty of the measured phase, the analyzer uses a low-loss air-capacitor as a phase standard, whose dissipation factor (D) is kept below 10^{-3} at around 1 GHz.

The following steps show how the analyzer improves phase measurement accuracy using a low-loss air-capacitor:

1. Measure the OPEN, SHORT, and LOAD standards and the Low-Loss air-capacitor.
2. Assuming the impedance of the 50 Ω LOAD is $\hat{Z}_{ls} = 50 e^{j0}$ (that is, the phase of 50 Ω LOAD is zero) as shown in Figure 11-12-(a)), calculate the calibration coefficient \hat{A} , \hat{B} , and \hat{C} .
3. Execute the correction for the Low-Loss air-capacitor and get the corrected impedance value of the Low-Loss air-capacitor. (\hat{Z}_{cc})
4. Calculate the phase difference ($\Delta\theta$) between the phase of \hat{Z}_{cc} and the true phase of the Low-Loss air-capacitor (see Figure 11-12-(b)).

$$\Delta\theta = \theta_{cc} - \theta_{cs} \quad (11-25)$$

Where,

$$\theta_{cc} = \arg(\hat{Z}_{cc})$$

θ_{cs} is standard phase value of the Low-Loss air-capacitor.

5. Modify the impedance of the 50 Ω LOAD to \hat{Z}_{lc} whose phase is $-\Delta\theta$ and whose impedance magnitude is still 50 Ω (see Figure 11-12-(c)). The modified impedance value of 50 Ω LOAD \hat{Z}_{lc} is expressed in the following equation:

$$\hat{Z}_{lc} = 50 e^{-j\Delta\theta} \quad (11-26)$$

6. Calculate the calibration coefficients A , B , and C again by normal OPEN SHORT LOAD calibration using the modified 50Ω LOAD impedance value \dot{Z}_{lc} .

The analyzer performs this procedure automatically when a Low-Loss air-capacitor is measured in the calibration menu. Although this is an approximate method, just performing these procedures make the analyzer accurate enough to perform high Q measurements.

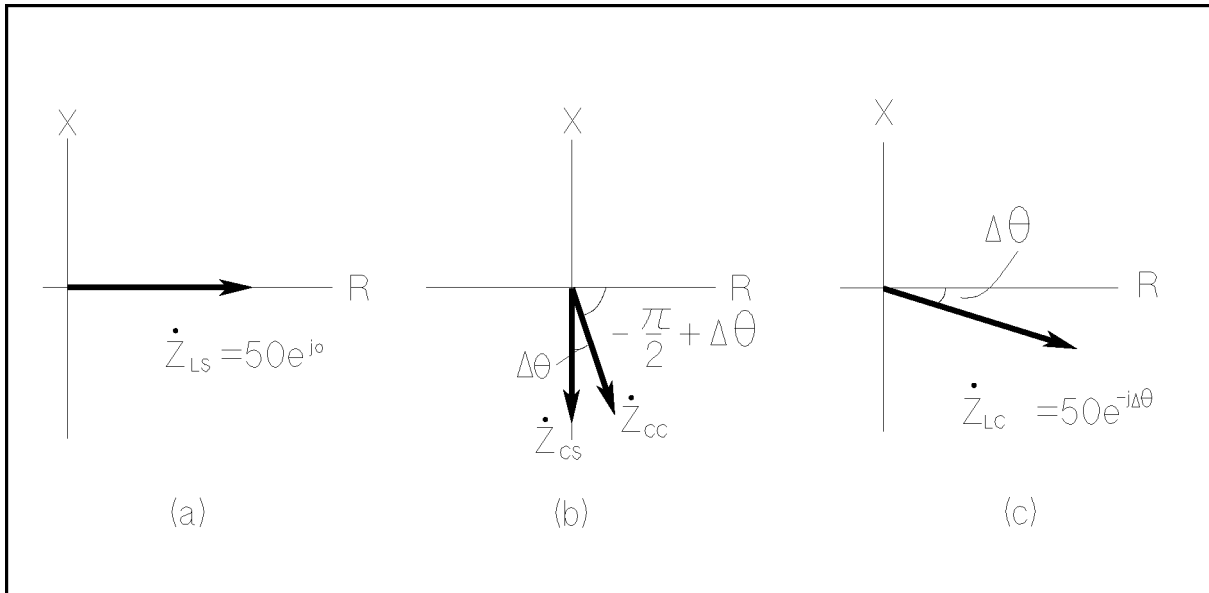

C6011012

Figure 11-12. Modifying the Standard Value of a 50Ω LOAD using a Low-Loss Air-Capacitor

<p>Low-Loss Air-Capacitor calibration does not affect the measurement below 300 MHz</p>
<p>In fact, taking frequency into consideration, the analyzer uses the following equations for \dot{Z}_{lc} :</p> $Z_{lc} = 50 e^{-jk\Delta\theta}$ <p>Where,</p> <p>k is a constant that depends on the measurement frequency. Because the phase of 50Ω LOAD at a low frequency is regarded as zero, the analyzer uses the following value as k:</p> <ul style="list-style-type: none"> ■ $k = 0$ (at frequency ≤ 300 MHz) ■ $k = \frac{f_{[MHz]} - 300}{500 - 300}$ (at $300 \text{ MHz} < \text{frequency} \leq 500 \text{ MHz}$) ■ $k = 1$ (at frequency > 500 MHz)

Port Extension

When the extension cable is used to extend the measurement plane from APC-7® of the head to the tip of the cable, the measurement error increases because of the additional impedance in a distributed element circuit of the cable.

To minimize the measurement errors, the port extension function simulates a variable length lossless cable that can be added to or removed from the test port to compensate for interconnecting cables, test fixtures, etc. The value of port extension is annotated in units of time with secondary labeling in distance for the velocity of light.

An estimated impedance value through this function is calculated according to the following concept:

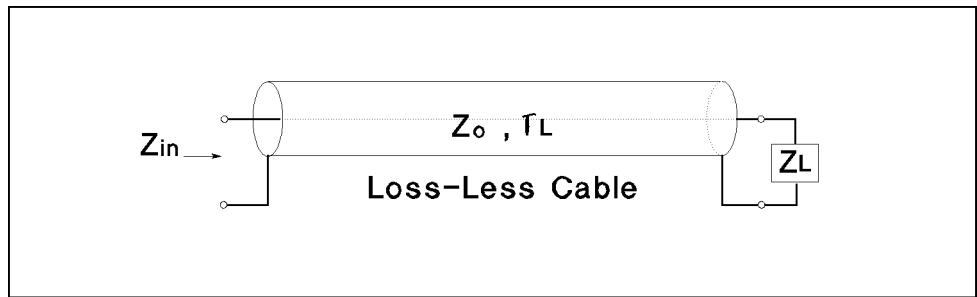

Figure 11-13. Port Extension

When impedance Z_L is connected to one tip of extension cable as shown in Figure 11-13, the input impedance from the other tip of cable is expressed using the following equation:

$$Z_{in} = Z_0 \frac{Z_L + Z_0 \tanh(\dot{\gamma}l)}{Z_0 + Z_L \tanh(\dot{\gamma}l)} \quad (11 - 27)$$

Where,

Z_0 is the characteristic impedance of the cable.

l is the electrical length of the cable representing the physical length of the cable (l_0) and the relative permittivity of the material in the cable (ϵ_r):

$$l = \sqrt{\epsilon_r} l_0 \quad (11 - 28)$$

$\dot{\gamma}$ is propagation coefficient and expressed as:

$$\dot{\gamma} = \alpha + j\beta \quad (11 - 29)$$

where,

α is attenuation constant

β is phase constant

Assuming that the cable is lossless, α and β satisfy the following conditions:

$$\alpha = 0 \quad (11 - 30)$$

$$\beta = \frac{\omega}{c_0} \quad (11 - 31)$$

where,

c_0 is the velocity of light

Therefore,

$$\begin{aligned} \tanh(jl) &= \tanh(j\frac{\omega}{c_0}l) \\ &= j \tan(\frac{\omega}{c_0}l) \end{aligned} \tag{11 - 32}$$

Because the characteristic impedance of the extension cable for the analyzer should be 50 Ω , Z_0 is constant as follows:

$$Z_0 = 50 + j0 \tag{11 - 33}$$

Substitute these conditions into the equation for Z_{in} . Then modify it in order to calculate Z_L from Z_{in} . Z_L can be determined by using the following equation:

$$Z_L = 50 \frac{Z_{in} - j50 \tan(\omega \Delta t)}{50 - jZ_{in} \tan(\omega \Delta t)} \tag{11 - 34}$$

Where,

Δt is port extension in time [sec]

$$\Delta t = \frac{l}{c_0}$$

When the linear portion of the DUT's phase is removed using the port extension function, the electrical length of the DUT can be read in the active entry area of the display.

Setting Proper Electrical Length Compensation
<p>You can easily check to determine whether the electrical length can fit the extended measurement circuit. Proceed as follows:</p> <ol style="list-style-type: none"> 1. Perform calibration without using an extension cable. 2. Connect the extension cable (or the unknown fixture) to the test port. 3. Set the measurement parameter to Γ. 4. Set the measurement format to Smith chart format. 5. Set the Smith/polar marker to Logmag-Phase. 6. Connect a 0 S termination at the tip of the extension cable (or an open at the tip of the extension cable). 7. Turn the port extension on. 8. Change the port extension value until the θ values measured are 0° at any frequency point.

Port Extension

Another Method of Canceling the Measurement Error Caused by Extension Cable

The OPEN-SHORT-LOAD fixture compensation cancels the error caused by port extension. To cancel the error:

1. Perform calibration at the tip of APC-7[®] on the test head without using an extension cable.
2. Connect the extension cable and the test fixture to be used.
3. Perform OPEN, SHORT, and LOAD fixture compensations.
 - It is necessary to perform calibration measurement *at the APC-7[®] connector of the test head*. If calibration is performed at the tip of the extension cable, the calibration error would increase.
 - OPEN, SHORT or OPEN and SHORT compensations can not cancel the error caused by the extension cable. It is the best way to perform the OPEN SHORT LOAD fixture compensation if the LOAD performance is perfectly known.

Fixture Compensation

Actual Measuring Circuit

The measuring circuit connecting a test sample to the test port (that is, the test fixture) actually becomes part of the sample that the instrument measures. In addition, component electrodes or leads, which should essentially be of negligibly low impedance, also influence the measured sample values because of the presence of certain parasitic impedances. Diverse parasitic impedances existing in the measuring circuit between the test port and the unknown device affect the measurement result. These parasitic impedances are present as resistive or reactive factors in parallel or in series with the sample device. Furthermore, in the high frequency region, the equivalent electrical length of the measuring circuit, including component leads, rotates the measured impedance vector as function of the test signal wavelength. Let's discuss the effects that increase measurement uncertainties.

Residual Parameter Effects

Figure 11-14 shows an equivalent circuit model of the measuring circuit that includes unknown component and parasitic parameters (usually called residual parameters). These residual parameters cause two kinds of measurement errors, which are described in the following paragraphs.

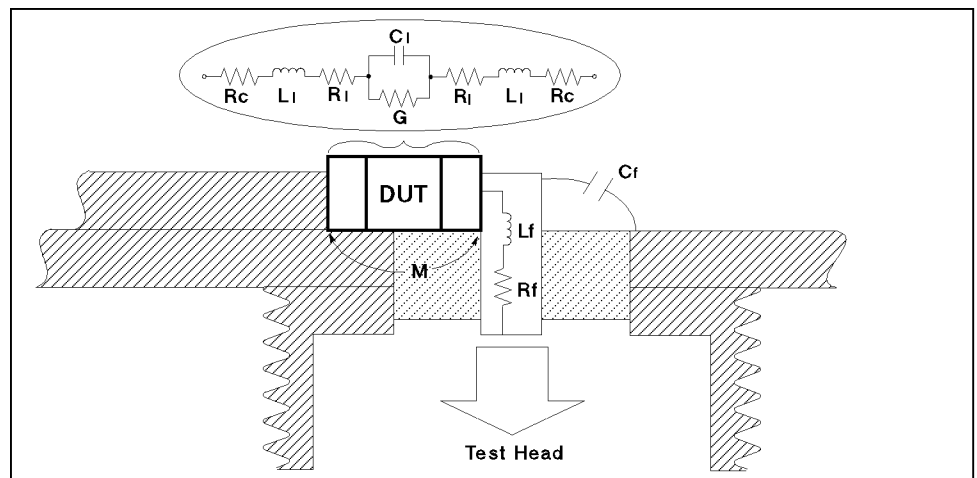

Figure 11-14. Residual Parameters in the Circuit

Where,

R_l	Lead (or electrodes) resistance of DUT
R_c	Contact resistance
R_f	Residual resistance of test fixture
L_l	Lead (or electrodes) inductance of DUT
L_f	Residual inductance of test fixture
C_l	Stray capacitance of DUT

Fixture Compensation

C_r	Stray capacitance of test fixture
G	Residual conductance of DUT
M	Mutual inductance between leads (or electrodes) of DUT

Characteristics of Test Fixture

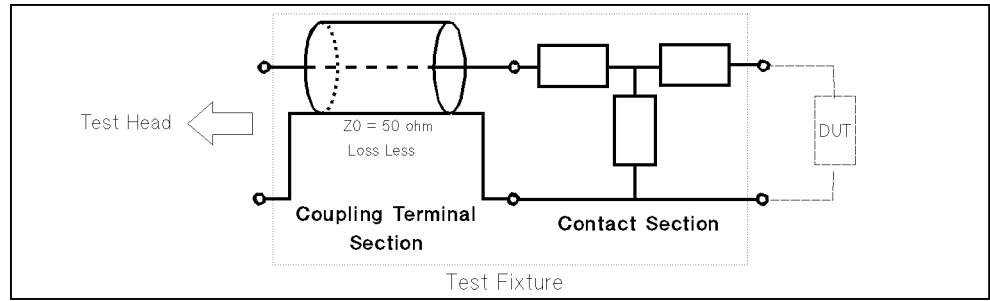

Figure 11-15. Characteristics of Test Fixture

Electrical Length of Coaxial Coupling Terminal Section

The test fixtures are basically composed of two major components, a coaxial coupling terminal and the contact electrodes (terminals), combined in one unit. The electrical length value specified for each type of fixture is calculated for the coaxial coupling terminal and does not include the electronic factors in the electrodes.

As the coaxial coupling terminal section of the fixtures is a distributed constant circuit design (50Ω), this fixture section is virtually an extension of the test port. The inherent effect in the coaxial coupling terminal is represented by the electrical length value particular to the test fixture. On the other hand, the contact section (that is, the electrodes on the fixtures) has different characteristics from the 50Ω distributed constant test port.

Elimination of Electrical Length Effects in Test Fixture

The 4291B has a typical electrical length for the specified test fixtures. When a test fixture is selected, the 4291B automatically sets the typical electrical length value for the fixture selected. The technique to eliminate the electrical length uses the same technique as the port extension function. See "Port Extension", for more information on port extension.

Residual and Stray Parameters of Contact Electrode Section

The contact electrode (terminal) section can not be regarded as part of the distributed constant circuit.

Because a correction calculation performed on the basis of the test fixture selection (provided by the 4291B) does not compensate for the residual and stray parameters in the contact section, these residuals and strays contribute to measurement errors. The residual and stray factors in the test fixtures is illustrated in Figure 11-14.

Elimination of Residual Parameter Effects in Test Fixture (Fixture Compensation)

In general, these residual and stray factors can be represented by F parameters of 2 terminal-pair as shown in Figure 11-16. Using this model, the residual and stray factors can be eliminated.

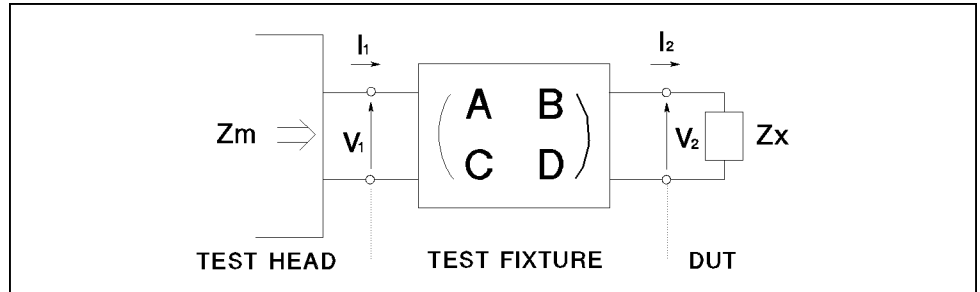

C601020

Figure 11-16.
Test Fixture Represented by the F matrix of a Two Terminal Pair Network

$$\begin{pmatrix} V_1 \\ I_1 \end{pmatrix} = \begin{pmatrix} A & B \\ C & D \end{pmatrix} \begin{pmatrix} V_2 \\ I_2 \end{pmatrix} \tag{11 - 35}$$

The actual impedance value of the DUT (Z_x) and the measurement value (Z_m) are represented by the input and output current and voltage as follows:

$$Z_m = \frac{V_1}{I_1} \tag{11 - 36}$$

$$Z_x = \frac{V_2}{I_2} \tag{11 - 37}$$

Then, Z_x is:

$$Z_x = A_{compen} \frac{Z_m - B_{compen}}{1 - Z_m C_{compen}} \tag{11 - 38}$$

Where,

$$A_{compen} = D/A$$

$$B_{compen} = B/D$$

$$C_{compen} = C/A$$

There are three unknown parameters. Therefore, three standards are needed for perfect compensation. When A_{compen} , B_{compen} , and C_{compen} are given, Z_x is calculated. To get A_{compen} , B_{compen} , and C_{compen} , the 4291B executes measurements for OPEN, SHORT, and LOAD compensation.

Fixture Compensation

Compensation Coefficient for Each Compensation

For fixture compensation, three compensations (OPEN, SHORT, and LOAD) are provided for the analyzer. These compensations can be turned on individually. After the compensation measurements have been done and tuned on, the compensation coefficients, A_{compen} , B_{compen} , and C_{compen} , are automatically calculated and the measurement value Z_m is transformed to Z_x through the equation (11-45). Some assumptions are made for compensations except for OPEN·SHORT·LOAD fixture compensation. The following paragraphs show the conditions assumed for each combination and the equations used for each combination of the OPEN, SHORT and LOAD fixture compensations.

OPEN Compensation

When only the OPEN compensation is used for the fixture compensation, two additional conditions are required to solve the Z_x equation. One condition assumes that the equivalent circuit model of the fixture used is a symmetric circuit. The other condition assumes that SHORT measurement capability is ideal, that is, the measurement value for perfect SHORT standard equals to perfect SHORT value. These conditions are explained as follows:

Assuming that :

$$A = D \text{ (symmetric circuit)} \quad (11-39)$$

$$B = 0 \quad (11-40)$$

Then, the compensation coefficients are:

$$A_{\text{compen}} = 1 + j0 \quad (11-41)$$

$$B_{\text{compen}} = 0 + j0 \quad (11-42)$$

$$C_{\text{compen}} = Y_{\text{om}} - Y_{\text{os}} \quad (11-43)$$

Where,

Y_{om} is the admittance value measured under open condition

Y_{os} is the admittance value defined as OPEN as the fixture compensation kit

SHORT Compensation

When only the SHORT compensation is used for the fixture compensation, two additional conditions are required to solve the Z_x equation. One condition assumes that the equivalent circuit model of the fixture used is a symmetric circuit. The other condition assumes that OPEN measurement capability is ideal, that is, the measurement value for perfect OPEN standard equals to perfect OPEN value. These conditions are explained as follows:

Assuming that :

$$A = D \text{ (symmetric circuit)} \quad (11-44)$$

$$C = 0 \quad (11-45)$$

Then, the compensation coefficients are:

Fixture Compensation

$$A_{\text{compen}} = 1 + j0 \quad (11-46)$$

$$B_{\text{compen}} = Z_{\text{sm}} - Z_{\text{ss}} \quad (11-47)$$

$$C_{\text{compen}} = 0 + j0 \quad (11-48)$$

Where,

Z_{sm} is the impedance of the value measured for shorted device.

Z_{ss} is the impedance value defined as SHORT for the fixture compensation kit

LOAD Compensation

When only the LOAD compensation is used for the fixture compensation, two additional conditions are required to solve the Z_x equation. One condition assumes that the value measuring shorted device is the same as the value defined as SHORT for the fixture compensation kit. The other condition assumes that SHORT measurement capability is ideal and OPEN measurement capability is ideal. These conditions are explained as follows:

Assuming that :

$$B=0 \quad (11-49)$$

$$C=0 \quad (11-50)$$

Then, the compensation coefficients are:

$$A_{\text{compen}} = \frac{Z_l}{Z_{lm}} \quad (11-51)$$

$$B_{\text{compen}} = 0 + j0 \quad (11-52)$$

$$C_{\text{compen}} = 0 + j0 \quad (11-53)$$

Where,

Z_{lm} is the impedance value measured for load device

Z_{ls} is the impedance value defined as LOAD of the fixture compensation kit

OPEN-SHORT Compensation

When OPEN and SHORT compensations are used for the fixture compensation, one additional condition is required to solve the Z_x equation. This condition is explained as follows:

Assuming that :

$$A=D \text{ (symmetric circuit)} \quad (11-54)$$

Then, the compensation coefficients are:

$$A_{\text{compen}} = 1 + j0 \quad (11-55)$$

$$B_{\text{compen}} = \frac{Z_{\text{sm}} - (1 - Y_{\text{om}}Z_{\text{sm}})Z_{\text{ss}} - Z_{\text{sm}}Y_{\text{os}}Z_{\text{ss}}}{1 - Y_{\text{om}}Z_{\text{sm}}Y_{\text{os}}Z_{\text{ss}}} \quad (11-56)$$

$$C_{\text{compen}} = \frac{Y_{\text{om}} - (1 - Y_{\text{om}}Z_{\text{sm}})Y_{\text{os}} - Y_{\text{om}}Y_{\text{os}}Z_{\text{ss}}}{1 - Y_{\text{om}}Z_{\text{sm}}Y_{\text{os}}Z_{\text{ss}}} \quad (11-57)$$

Fixture Compensation

OPEN-LOAD Compensation

When OPEN and LOAD compensations are used for the fixture compensation, one additional condition is required to solve the Z_x equation. The condition assumes that SHORT measurement capability is ideal, that is, the measurement value for perfect SHORT standard equals to perfect SHORT value. This condition is explained as follows:

Assuming that :

$$B = 0 \quad (11-58)$$

Then, the compensation coefficients are:

$$A_{\text{compen}} = \frac{Y_{lm} - Y_{om}}{Y_{ls} - Y_{os}} \quad (11-59)$$

$$B_{\text{compen}} = 0 + j0 \quad (11-60)$$

$$C_{\text{compen}} = \frac{Y_{om}Y_{ls} - Y_{lm}Y_{os}}{Y_{ls} - Y_{os}} \quad (11-61)$$

SHORT-LOAD Compensation

When SHORT and LOAD compensations are used for the fixture compensation, one additional condition is required to solve the Z_x equation. The condition assumes that SHORT measurement capability is ideal, that is, the measurement value for perfect OPEN standard equals to perfect OPEN value. This condition is explained as follows:

Assuming that :

$$C = 0 \quad (11-62)$$

Then, the compensation coefficients are:

$$A_{\text{compen}} = \frac{Z_{ss} - Z_{ls}}{Z_{sm} - Z_{lm}} \quad (11-63)$$

$$B_{\text{compen}} = \frac{Z_{lm}Z_{ss} - Z_{sm}Z_{ls}}{Z_{ss} - Z_{ls}} \quad (11-64)$$

$$C_{\text{compen}} = 0 + j0 \quad (11-65)$$

OPEN-SHORT-LOAD Compensation

When OPEN, SHORT and LOAD compensations used for the fixture compensation, no more conditions are required to solve the Z_x equation. The compensation coefficients are:

$$A_{\text{compen}} = \frac{Y_{om}(Z_{sm} - Z_{lm})Y_{os}Z_{ss}Z_{ls} - (1 - Z_{lm}Y_{om})Z_{ls} + (1 - Y_{om}Z_{sm})Z_{ss}}{(Z_{sm} - Z_{lm}) - (1 - Z_{lm}Y_{om})Z_{sm}Y_{os}Z_{ss} + (1 - Y_{om}Z_{sm})Z_{lm}Z_{ls}Y_{os}} \quad (11-66)$$

$$B_{\text{compen}} = \frac{(Z_{sm} - Z_{lm})Y_{os}Z_{ss}Z_{ls} - Z_{sm}(1 - Z_{lm}Y_{om})Z_{ls} + Z_{lm}(1 - Y_{om}Z_{sm})Z_{ss}}{Y_{om}(Z_{sm} - Z_{lm})Y_{os}Z_{ss}Z_{ls} - (1 - Z_{lm}Y_{om})Z_{ls} + (1 - Y_{om}Z_{sm})Z_{ss}} \quad (11-67)$$

Fixture Compensation

$$C_{\text{compen}} = \frac{Y_{\text{om}}(Z_{\text{sm}} - Z_{\text{lm}}) - (1 - Z_{\text{lm}}Y_{\text{om}})Y_{\text{os}}Z_{\text{ss}} + (1 - Y_{\text{om}}Z_{\text{sm}})Z_{\text{ls}}Y_{\text{os}}}{(Z_{\text{sm}} - Z_{\text{lm}}) - (1 - Z_{\text{lm}}Y_{\text{om}})Z_{\text{sm}}Y_{\text{os}}Z_{\text{ss}} + (1 - Y_{\text{om}}Z_{\text{sm}})Z_{\text{lm}}Z_{\text{ls}}Y_{\text{os}}}$$

(11-68)

Permittivity Measurements

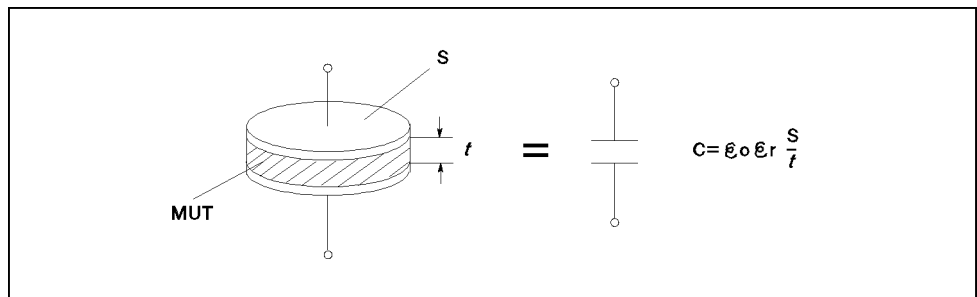

Figure 11-17. Schematic Electrode Structure of the 16453A

In general, when a dielectric material is put in a pair of parallel flat electrodes, capacitance C is calculated using the following equation:

$$C = \epsilon_0 \epsilon_r \frac{S}{t} \tag{11 - 69}$$

Complex Permittivity

Strictly speaking, when ac voltage is applied to the dielectric material, the material has some loss and permittivity ϵ_r is defined as the following complex value:

$$\hat{\epsilon}_r = \epsilon'_r - j\epsilon''_r \tag{11 - 70}$$

Now, the capacitor has a loss factor and the capacitance C in equation (11-76) can be modified to the complex admittance \dot{Y} as follows:

$$C \rightarrow \frac{\dot{Y}}{j\omega} \tag{11 - 71}$$

$$\frac{\dot{Y}}{j\omega} = \epsilon_0 \hat{\epsilon}_r \frac{S}{t} \tag{11 - 72}$$

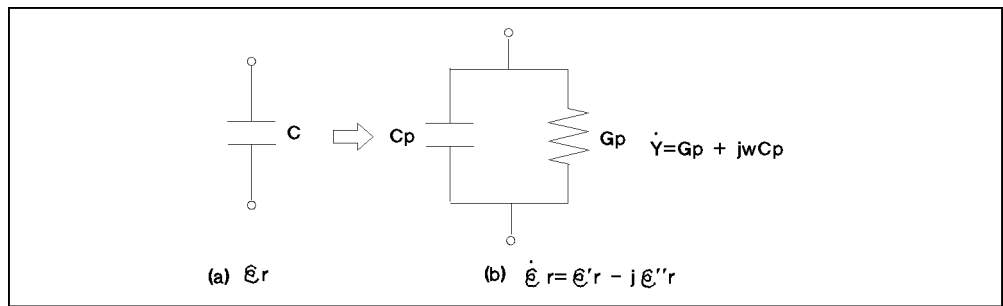

Figure 11-18. Material has some loss

Therefore, the relative permittivity of the MUT can be obtained using the following equation:

$$\hat{\epsilon}_r = \frac{1}{\epsilon_0} \frac{\dot{Y}_m t}{j\omega S}$$

$$= \frac{\dot{Y}_m}{j\omega C_0} \quad (11 - 73)$$

Where,

\dot{Y}_m is the measurement admittance value of the MUT.

C_0 is the capacitance value of the air gap (whose distance between electrodes is same as the thickness of the MUT).

$$C_0 = \epsilon_0 \frac{S}{d} \quad (11 - 74)$$

Characteristics of Test Fixture

Edge Effect

When the capacitance of the material is measured, stray capacitance exists at edge of electrodes (see Figure 11-19).

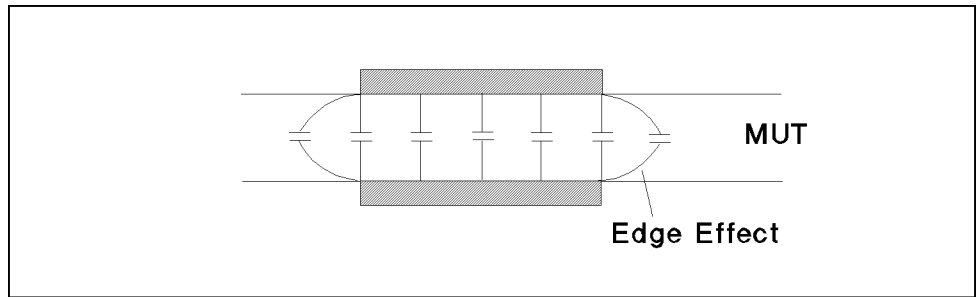

Figure 11-19. Edge Effect

Because measurement result is a summation of the capacitance of a MUT and the stray capacitance caused by the edge effect, the edge effect is generally expressed as follows:

$$C_0(1 + E_{edge}) \quad (11 - 75)$$

Where,

E_{edge} is the compensation coefficient for the edge effect, which is determined by the gap between electrode and relative permittivity of MUT.

Adding the edge effect to C_0 in equation (11-73), the relative permittivity of the MUT can be obtained by using the following equation:

$$\hat{\epsilon}_r = \frac{\dot{Y}_m}{j\omega C_0(1 + E_{edge})} \quad (11 - 76)$$

Permittivity Measurements

The Analyzer uses an approximately value as E_{edge} of 16453A
The analyzer uses the following approximate value of E_{edge} for the 16453A: $E_{edge} = 434t^{0.825}\epsilon_r^{-0.554}$ where, t : [m]

Residual Parameter

In fact the 16453A has residual impedance and stray admittance, which cause an increased error when measuring the admittance of the MUT. To eliminate residual and stray admittance, the OPEN, SHORT, and LOAD fixture compensations are required for any permittivity measurement using the 16453A.

Because the equation to compensate for measurement admittance value is same as the equation for the OPEN-SHORT-LOAD fixture compensation for impedance measurement, see "Fixture Compensation" for more information on OPEN, SHORT, and LOAD fixture compensation.

Permeability Measurements

In general, when current is flowing along an infinity line (as shown in (a) of Figure 11-20), magnetic flux density \mathbf{B} is generated by the current as follows:

$$\mathbf{B} = \frac{\mu \mathbf{I}}{2\pi r} \quad (11 - 77)$$

When current is flowing in a closed loop (as shown in (b) of Figure 11-20), the magnetic flux Φ generated by the current is :

$$\Phi = LI \quad (11 - 78)$$

Where, L is the self-inductance of the closed loop.

Because the magnetic flux is calculated by the surface integral of the magnetic flux density \mathbf{B} (s shown in (c) of Figure 11-20), Φ is also expressed by the following equations:

$$\Phi = \int \mathbf{B} ds \quad (11 - 79)$$

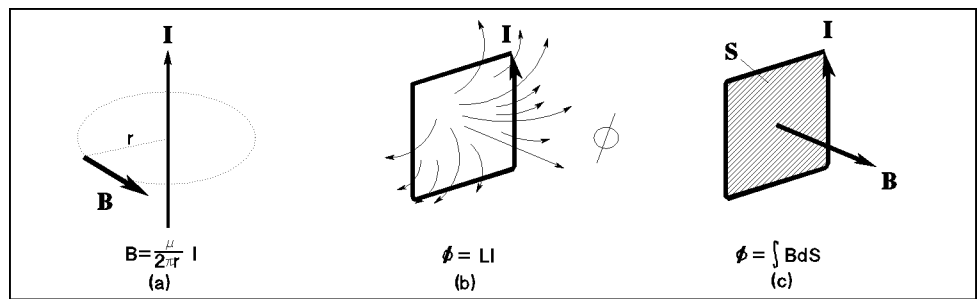

0601022

Figure 11-20.
Basic Relationship of Magnetic Flux Density, Magnetic Flux, and Current

Figure 11-21 shows the schematic fixture structure of the 16454A.

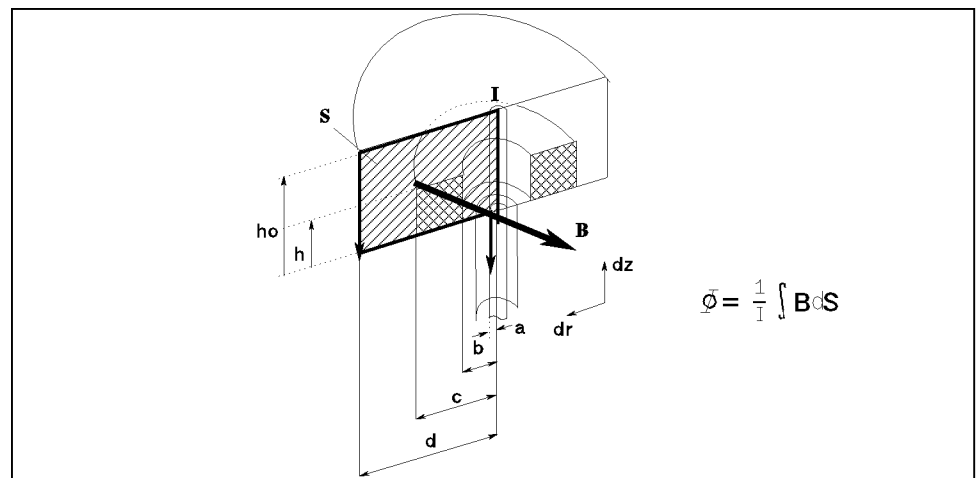

0601023

Figure 11-21. Schematic Fixture Structure of 16454A

Permeability Measurements

The 16454A measures core shape magnetic material as shown in Figure 11-21. Erasing \mathbf{B} and Φ and considering the physical shape and dimensions of the 16454A, the self-inductance of the measurement circuit including MUT is derived as follows:

$$L = \frac{1}{I} \int \mathbf{B} ds$$

$$= \int_a^d \int_0^{h_0} \frac{\mu}{2\pi r} dr dz \quad (11-80)$$

$$= \frac{\mu_0}{2\pi} \left\{ (\mu_r - 1)h \ln \frac{c}{b} + h_0 \ln \frac{d}{a} \right\} \quad (11-81)$$

Modify equation (11-87) to get the relative permeability μ_r of MUT:

$$\mu_r = \frac{2\pi}{\mu_0} \frac{L - L_{ss}}{F} + 1 \quad (11-82)$$

Where,

L_{ss} is the self-inductance of the fixture when it is empty.

$$L_{ss} = \frac{\mu_0}{2\pi} h_0 \ln \frac{b}{a} \quad (11-83)$$

F is the shape function of MUT, which is decided by its dimensions only.

$$F = h \ln \frac{a}{b} \quad (11-84)$$

Complex Permeability

When the magnetic field generated by an ac current is flowing is applied to the magnetic material, the permeability is defined by the complex value shown in equation (11-92).

$$\dot{\mu}_r = \mu'_r - j\mu''_r \quad (11-85)$$

Now, because the inductor has a loss factor, the inductance in equations (11-87) through (1-89) must be modified to a complex impedance, which includes the loss:

$$L \rightarrow \frac{\dot{Z}}{j\omega} \quad (11-86)$$

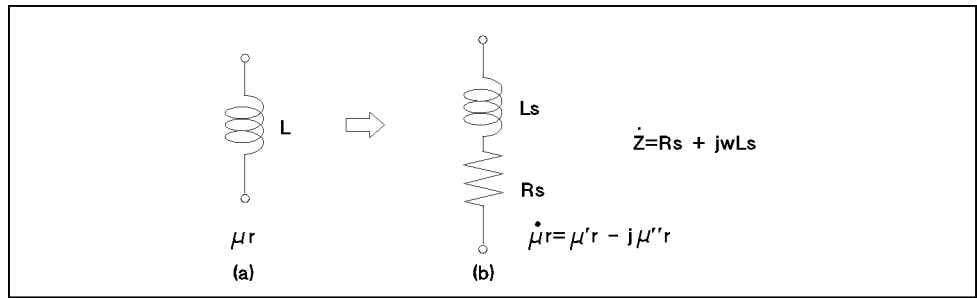

Figure 11-22. Material Has Loss

The complex relative permeability of the MUT can then be determined by the following equation:

$$\dot{\mu}_r = \frac{2\pi}{\mu_0} \frac{j\omega \dot{Z} - L_{ss}}{F} + 1 \quad (11 - 87)$$

The analyzer measures impedance (\dot{Z}) and calculates $\dot{\mu}_r$ using this equation.

Characteristics of the Test Fixture

Residual Parameter

The 16454A has residual impedance. The residual impedance \dot{Z}_{res} is represented by a series impedance as shown in Figure 11-23.

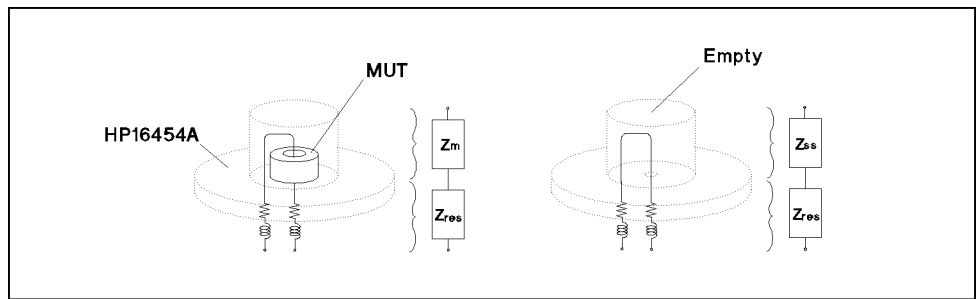

Figure 11-23. Residual Impedance of the 16454A

Assuming that the impedance value of the empty test fixture is known, the residual impedance can be specified by measuring the fixture with no MUT (empty).

$$\dot{Z}_{res} = \dot{Z}_{sm} - \dot{Z}_{ss} \quad (11 - 88)$$

Where,

\dot{Z}_{ss} is the ideal value of the impedance when the fixture is empty.
 \dot{Z}_{sm} is the measurement value of the impedance when the fixture is empty.

Elimination of Residual Impedance Effects in the Test Fixture (SHORT Fixture Compensation)

The SHORT fixture compensation can eliminate the residual impedance effect. When the SHORT (empty) compensation measurement has been performed, the compensated impedance \dot{Z}_{comp} can be expressed by the following equation:

$$\dot{Z}_{comp} = \dot{Z}_m - \dot{Z}_{res} \quad (11 - 89)$$

Assuming that \dot{Z}_{ss} has only an inductance factor ($\dot{Z}_{ss} = j\omega L_{ss}$), and using the compensated impedance value \dot{Z}_{comp} , the permeability of the MUT can be derived from \dot{Z}_m and \dot{Z}_{sm} as follows:

$$\dot{\mu}_r = \frac{2\pi}{\mu_0} \frac{\dot{Z}_m - \dot{Z}_{sm}}{j\omega F} + 1 \quad (11 - 90)$$

Permeability Measurements

Impedance Parameter Value Displayed for Magnetic Material Measurement

When the 4291B measures magnetic materials, the impedance parameter value displayed is calculated from the following impedance value (\dot{Z}):

$$\dot{Z} = j\omega h \frac{\dot{\mu}_m \mu_0}{2\pi} \ln \frac{c}{b}$$

Where,

$\dot{\mu}_m$ is measurement complex permeability value of MUT

b is inner diameter of MUT

c is outer diameter of MUT

Specifications describe the instrument's warranted performance over the temperature range of 0°C to 40°C (except as noted). Supplemental characteristics are intended to provide information that is useful in applying the instrument by giving non-warranted performance parameters. These are denoted as *typical*, *typically*, *nominal* or *approximate*. Warm up time must be greater than or equal to 30 minutes after power on for all specifications. Specifications of the stimulus characteristics and measurement accuracy are defined at the tip of APC-7® connector on the test head connected to the instrument.

Measurement Parameter

Impedance parameters $|Z|, \theta_z, |Y|, \theta_y, R, X, G, B, C_p, C_s, L_p, L_s, R_p, R_s, D, Q, |\Gamma|, \theta_\gamma, \Gamma_x, \Gamma_y$

Stimulus Characteristics

Frequency Characteristics

Operating frequency 1 MHz to 1.8 GHz
Frequency resolution 1 mHz
Frequency reference
Accuracy
 @ 23±5°C < ±10 ppm
Precision frequency reference (Option 1D5)
Accuracy
 @ 0°C to 40°C < ±1 ppm

Source Characteristics

OSC level
Voltage range
 @1 MHz ≤ Frequency ≤ 1 GHz (When terminal is open)
 0.2 mV_{rms} to 1 V_{rms}
 @1 GHz < Frequency ≤ 1.8 GHz (When terminal is open)
 0.2 mV_{rms} to 0.5 V_{rms}
Current range
 @1 MHz ≤ Frequency ≤ 1 GHz (When terminal is shorted)
 4 μA_{rms} to 20 mA_{rms}
 @1 GHz < Frequency ≤ 1.8 GHz (When terminal is shorted)

Permeability Measurements

.....	4 μA_{rms} to 10 mA_{rms}
Power range	
@1 MHz \leq Frequency \leq 1 GHz (When terminating with 50 Ω) -67 dBm to 7 dBm
@1 GHz < Frequency \leq 1.8 GHz (When terminating with 50 Ω) -67 dBm to 1 dBm
OSC level resolution	
AC voltage resolution	
@ 0.22 $\text{V}_{\text{rms}} < V_{\text{OSC}} \leq 1 \text{V}_{\text{rms}}$ 2 mV
@ 70 m $\text{V}_{\text{rms}} < V_{\text{OSC}} \leq 220 \text{mV}_{\text{rms}}$ 0.5 mV
@ 22 m $\text{V}_{\text{rms}} < V_{\text{OSC}} \leq 70 \text{mV}_{\text{rms}}$ 0.2 mV
@ 7 m $\text{V}_{\text{rms}} < V_{\text{OSC}} \leq 22 \text{mV}_{\text{rms}}$ 0.05 mV
@ 2.2 m $\text{V}_{\text{rms}} < V_{\text{OSC}} \leq 7 \text{mV}_{\text{rms}}$ 0.02 mV
@ 0.7 m $\text{V}_{\text{rms}} < V_{\text{OSC}} \leq 2.2 \text{mV}_{\text{rms}}$ 0.005 mV
@ 0.2 m $\text{V}_{\text{rms}} \leq V_{\text{OSC}} \leq 0.7 \text{mV}_{\text{rms}}$ 0.002 mV
AC current resolution	
@ 4.4 $\text{mA}_{\text{rms}} < I_{\text{OSC}} \leq 20 \text{mA}_{\text{rms}}$ 40 μA
@ 1.4 $\text{mA}_{\text{rms}} < I_{\text{OSC}} \leq 4.4 \text{mA}_{\text{rms}}$ 10 μA
@ 0.44 $\text{mA}_{\text{rms}} < I_{\text{OSC}} \leq 1.4 \text{mA}_{\text{rms}}$ 4 μA
@ 140 $\mu\text{A}_{\text{rms}} < I_{\text{OSC}} \leq 440 \mu\text{A}_{\text{rms}}$ 1 μA
@ 44 $\mu\text{A}_{\text{rms}} < I_{\text{OSC}} \leq 140 \mu\text{A}_{\text{rms}}$ 0.4 μA
@ 14 $\mu\text{A}_{\text{rms}} < I_{\text{OSC}} \leq 44 \mu\text{A}_{\text{rms}}$ 0.1 μA
@ 4 $\mu\text{A}_{\text{rms}} \leq I_{\text{OSC}} \leq 14 \mu\text{A}_{\text{rms}}$ 0.04 μA
AC power resolution 0.1 dBm
OSC level accuracy $A + B + \frac{6_{[\text{dB}]} \times f_{[\text{MHz}]}}{1800}$ dB

where,

A depends on temperature conditions as follows:

- @ within referenced to $23 \pm 5^\circ\text{C}$ 2 dB
- @ other environmental temperature conditions 4 dB

B depends on OSC level as follows:

- @ $V_{\text{osc}} \geq 250 \text{mV}_{\text{rms}}$ 0 dB
($I_{\text{osc}} \geq 5 \text{mA}_{\text{rms}}$)
($P_{\text{osc}} \geq -5 \text{dBm}$)
- @ $250 \text{mV}_{\text{rms}} > V_{\text{osc}} \geq 2.5 \text{mV}_{\text{rms}}$ 1 dB
($5 \text{mA}_{\text{rms}} > I_{\text{osc}} \geq 50 \mu\text{A}_{\text{rms}}$)
($-5 \text{dBm} > P_{\text{osc}} \geq -45 \text{dBm}$)
- @ other OSC level 2 dB

Definition of OSC level
■ Voltage level : 2 x voltage level across the 50 Ω which is connected to the output terminal. (this level is approximately equal to the level when a terminal is open)
■ Current level : 2 x current level through the 50 Ω which is connected to the output terminal. (this level is approximately equal to the level when a terminal is shorted)
■ Power level : when terminating with 50 Ω .

OSC level accuracy 1/2 of specification value (typical)
Connector APC7®
Output impedance 50 Ω (Nominal value)
DC bias (Option 001)	
DC voltage level 0 to $\pm 40\text{V}$
DC current level 20 μA to 100 mA and -20 μA to -100mA

Permeability Measurements

DC level resolution 1mV, 20 μ A

DC level accuracy

@23 \pm 5 °C

Voltage 0.1 % + 4 mV + (I_{dc} [mA] \times 5 [Ω]) mV

Current 0.5 % + 30 μ A + (V_{dc} [V]/10 [$k\Omega$]) mA

@ 8 to 18°C and 28 to 38°C

Voltage 0.2 % + 8 mV + (I_{dc} [mA] \times 10 [Ω]) mV

Current 1 % + 60 μ A + (V_{dc} [V]/5 [$k\Omega$]) mA

@ 0 to 8°C and 38 to 40°C

Voltage 0.3 % + 12 mV + (I_{dc} [mA] \times 15 [Ω]) mV

Current 1.5 % + 90 μ A + (V_{dc} [V] \times 3/10 [$k\Omega$]) mA

Level monitor

Monitor parameters OSC level (voltage, current), DC bias (voltage, current)

Monitor accuracy

OSC level Same as OSC level accuracy (typical)

DC bias

.. Twice as bad as specifications of dc level accuracy (typical)

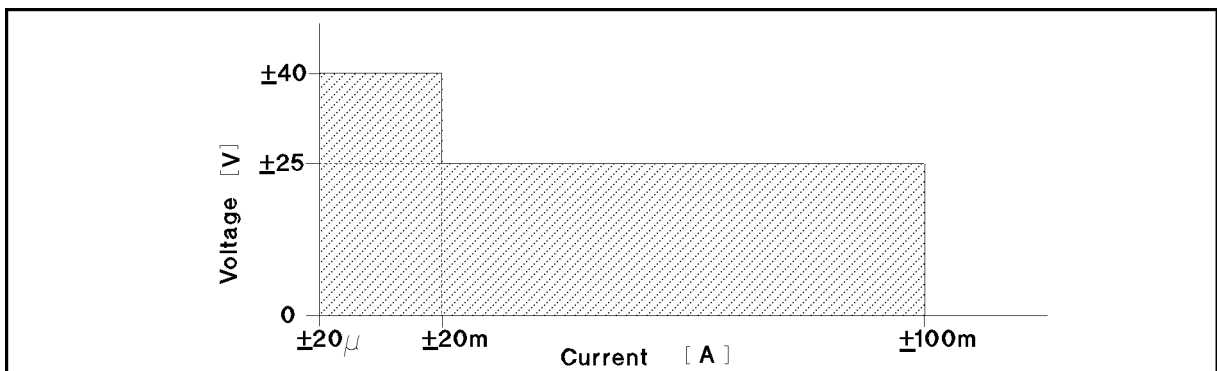

0660009

Figure 12-1. DC Voltage and Current Level Range (Typical)

Sweep Characteristics

Sweep parameter Frequency, OSC level (voltage), DC bias voltage/current

Sweep setup Start Stop, or Center Span

Sweep type

Frequency sweep Linear, Log, Zero-span, List

Other sweep parameters Linear, Log, Zero-span

Sweep mode Continuous, Single, Manual, Number of groups

Sweep direction

AC level, DC bias (voltage and current) .. Up sweep, Down sweep

Other sweep parameters Up sweep

Number of measurement point 2 to 801 points

Averaging Sweep average, Point average

Delay time Point delay time, Sweep delay time

Permeability Measurements

Measurement circuit mode series circuit mode, parallel circuit mode

Calibration/Compensation

Calibration function

. Open/Short/50 Ω calibration , Low loss calibration

Compensation function

. . . Open/Short/Load compensation, Port extension, Electric length

Measurement Accuracy

Conditions of accuracy specifications
<ul style="list-style-type: none"> ■ Open/Short/50 Ω calibration must be done. Calibration ON. ■ Averaging (on point) factor is larger than 32 at which calibration is done if Cal points is set to USER DEF. ■ Measurement points are same as the calibration points. ■ Environment temperature is within ±5°C of temperature at which calibration is done, and within 13°C to 33°C. Beyond this environmental temperature condition, accuracy is twice as bad as specified.

|Z|, |Y| Accuracy ±(E_a + E_b) [%]

The illustrations of |Z| and |Y| accuracy are shown in Figure 12-2 to Figure 12-5.

θ Accuracy ± $\frac{(E_a + E_b)}{100}$ [rad]

L, C, X, B Accuracy ±(E_a + E_b) × $\sqrt{(1 + D_x^2)}$ [%]

R, G Accuracy ±(E_a + E_b) × $\sqrt{(1 + Q_x^2)}$ [%]

D Accuracy (ΔD)

@ $|D_x \tan(\frac{E_a + E_b}{100})| < 1$ ± $\frac{(1 + D_x^2) \tan(\frac{E_a + E_b}{100})}{1 \mp D_x \tan(\frac{E_a + E_b}{100})}$

Especially, @ $D_x \leq 0.1$ ± $\frac{(E_a + E_b)}{100}$

Q Accuracy (ΔQ)

@ $|Q_x \tan(\frac{E_a + E_b}{100})| < 1$ ± $\frac{(1 + Q_x^2) \tan(\frac{E_a + E_b}{100})}{1 \mp Q_x \tan(\frac{E_a + E_b}{100})}$

Especially, @ $\frac{10}{(E_a + E_b)} \geq Q_x \geq 10$ ± $Q_x^2 \frac{(E_a + E_b)}{100}$

where,

D_x : Measured value of D

E_a : depends on measurement frequency as follows:

@ 1 MHz < Frequency ≤ 100 MHz 0.6

@ 100 MHz < Frequency ≤ 500 MHz 0.8

@ 500 MHz < Frequency ≤ 1000 MHz 1.2

@ 1000 MHz < Frequency ≤ 1800 MHz 2.0

E_b = (Z_s/|Z_x| + Y_o|Z_x|) × 100

Q_x : Measured value of Q

Z_x : impedance measurement value [Ω]

Z_s and **Y_o** depend on number of point averaging (N_{av}), OSC level (V_{osc}), impedance measurement value (Z_x) and the test head used as follows:

Permeability Measurements

Table 12-1. Z_s and Y_o when High Impedance Test Head is used

Measurement Conditions			Z_s [Ω]	Y_o [S]
Number of Point Averaging (N_{av})	OSC Signal Level (V_{osc})	Meas. Impedance (Z_x)		
$1 \leq N_{av} \leq 7$	$V_{osc} < 0.02$ V	—	$\frac{0.02}{V_{osc}} \times (0.2 + 0.001 \times f_{[MHz]})$	$\frac{0.02}{V_{osc}} \times (5 \times 10^{-5} + 2 \times 10^{-7} \times f_{[MHz]})$
	0.02 V $\leq V_{osc} < 0.12$ V	—	$0.2 + 0.001 \times f_{[MHz]}$	$5 \times 10^{-5} + 2 \times 10^{-7} \times f_{[MHz]}$
	0.12 V $\leq V_{osc}$	$Z_x \geq 500$ Ω	$0.2 + 0.001 \times f_{[MHz]}$	$5 \times 10^{-6} + 2 \times 10^{-7} \times f_{[MHz]}$
$Z_x < 500$ Ω		$0.2 + 0.001 \times f_{[MHz]}$	$2 \times 10^{-5} + 2 \times 10^{-7} \times f_{[MHz]}$	
$N_{av} \geq 8$	$V_{osc} < 0.02$ V	—	$\frac{0.02}{V_{osc}} \times (0.1 + 5 \times 10^{-4} \times f_{[MHz]})$	$\frac{0.02}{V_{osc}} \times (2 \times 10^{-5} + 1 \times 10^{-7} \times f_{[MHz]})$
	0.02 V $\leq V_{osc} < 0.12$ V	—	$0.1 + 5 \times 10^{-4} \times f_{[MHz]}$	$2 \times 10^{-5} + 1 \times 10^{-7} \times f_{[MHz]}$
	0.12 V $\leq V_{osc}$	$Z_x \geq 500$ Ω	$0.1 + 5 \times 10^{-4} \times f_{[MHz]}$	$2 \times 10^{-6} + 1 \times 10^{-7} \times f_{[MHz]}$
		$Z_x < 500$ Ω	$0.1 + 5 \times 10^{-4} \times f_{[MHz]}$	$7 \times 10^{-6} + 1 \times 10^{-7} \times f_{[MHz]}$

Table 12-2. Z_s and Y_o when Low Impedance Test Head is used

Measurement Conditions			Z_s [Ω]	Y_o [S]
Number of Point Averaging (N_{av})	OSC Signal Level (V_{osc})	Meas. Impedance (Z_x)		
$1 \leq N_{av} \leq 7$	$V_{osc} < 0.02$ V	—	$\frac{0.02}{V_{osc}} \times (0.1 + 0.001 \times f_{[MHz]})$	$\frac{0.02}{V_{osc}} \times (1 \times 10^{-4} + 2 \times 10^{-7} \times f_{[MHz]})$
	0.02 V $\leq V_{osc} < 0.12$ V	—	$0.1 + 0.001 \times f_{[MHz]}$	$1 \times 10^{-4} + 2 \times 10^{-7} \times f_{[MHz]}$
	0.12 V $\leq V_{osc}$	$Z_x \leq 5$ Ω	$0.01 + 0.001 \times f_{[MHz]}$	$1 \times 10^{-4} + 2 \times 10^{-7} \times f_{[MHz]}$
$Z_x > 5$ Ω		$0.05 + 0.001 \times f_{[MHz]}$	$1 \times 10^{-4} + 2 \times 10^{-7} \times f_{[MHz]}$	
$N_{av} \geq 8$	$V_{osc} < 0.02$ V	—	$\frac{0.02}{V_{osc}} \times (0.05 + 5 \times 10^{-4} \times f_{[MHz]})$	$\frac{0.02}{V_{osc}} \times (3 \times 10^{-5} + 1 \times 10^{-7} \times f_{[MHz]})$
	0.02 V $\leq V_{osc} < 0.12$ V	—	$0.05 + 5 \times 10^{-4} \times f_{[MHz]}$	$3 \times 10^{-5} + 1 \times 10^{-7} \times f_{[MHz]}$
	0.12 V $\leq V_{osc}$	$Z_x \leq 5$ Ω	$0.01 + 5 \times 10^{-4} \times f_{[MHz]}$	$3 \times 10^{-5} + 1 \times 10^{-7} \times f_{[MHz]}$
		$Z_x > 5$ Ω	$0.02 + 5 \times 10^{-4} \times f_{[MHz]}$	$3 \times 10^{-5} + 1 \times 10^{-7} \times f_{[MHz]}$

At the following frequency points, instrument spurious characteristics could occasionally cause measurement errors to exceed specified value because of instrument spurious characteristics.

10.71 MHz	17.24 MHz	21.42 MHz	42.84 MHz
514.645 MHz	686.19333 MHz	1029.29 MHz	1327.38666 MHz

See “EMC” under “Others” in “General Characteristics”.

Permeability Measurements

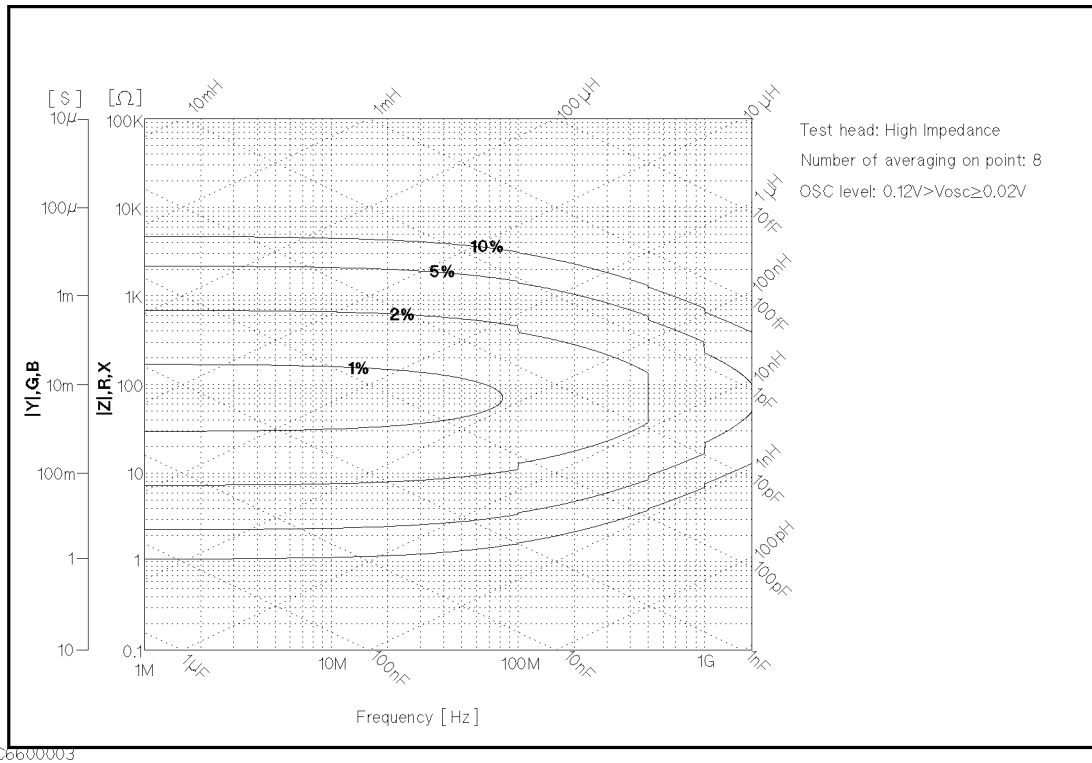

Figure 12-2.
Impedance Measurement Accuracy Using High Impedance Test Head (@ Low OSC Level)

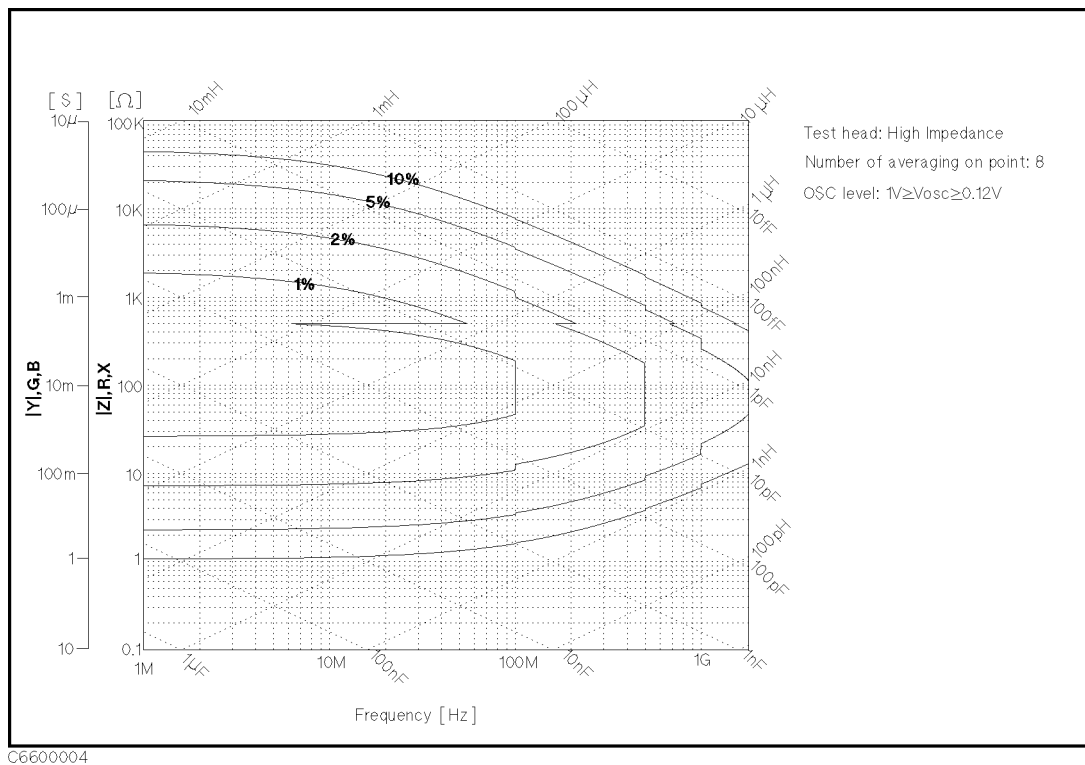
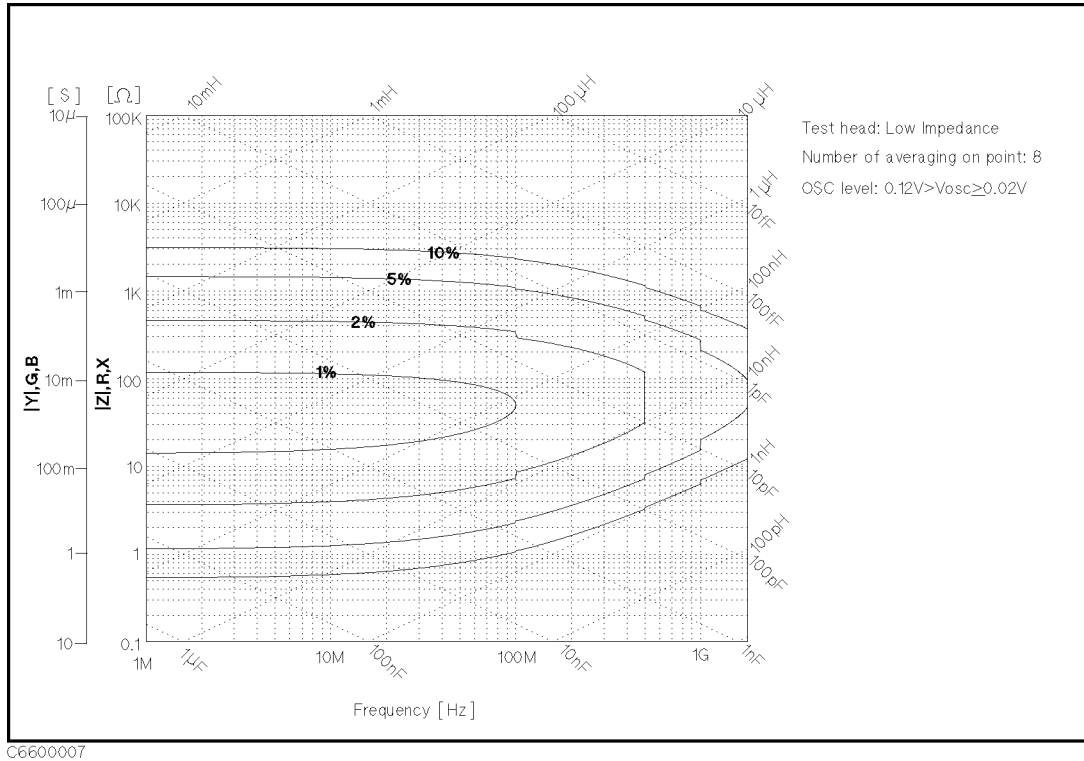

Figure 12-3.
Impedance Measurement Accuracy Using High Impedance Test Head (@ High OSC Level)

Permeability Measurements



C6600007

Figure 12-4.
Impedance Measurement Accuracy Using Low Impedance Test Head (@ Low OSC Level)

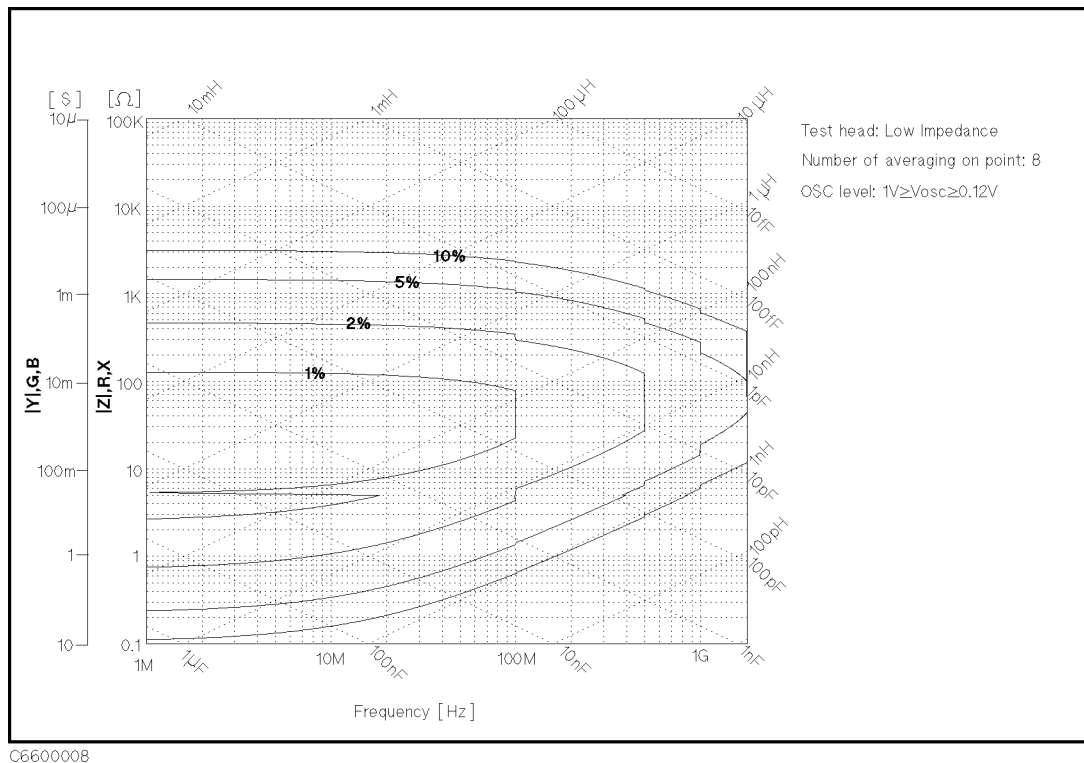

C6600008

Figure 12-5.
Impedance Measurement Accuracy Using Low Impedance Test Head (@ High OSC Level)

Typical measurement accuracy when open/short/50 Ω/low-loss-capacitor calibration is done	
Conditions	
<ul style="list-style-type: none"> ■ Averaging on point factor is larger than 32 at which calibration is done. ■ Cal Points is set to USER DEF. ■ Environment temperature is within ±5 °C of temperature at which calibration is done, and within 13 °C to 33 °C. Beyond this environmental temperature condition, accuracy is twice as bad as specified. 	
 Z , Y Accuracy	$\pm(E_a + E_b)$ [%]
θ Accuracy	$\pm \frac{E_c}{100}$ [rad]
L, C, X, B Accuracy	$\pm \sqrt{(E_a + E_b)^2 + (E_c D_x)^2}$ [%]
R, G Accuracy	$\pm \sqrt{(E_a + E_b)^2 + (E_c Q_x)^2}$ [%]
D Accuracy	
@ $ D_x \tan(E_c/100) < 1$	$\pm \frac{(1 + D_x^2) \tan(E_c/100)}{1 \mp D_x \tan(E_c/100)}$
Especially, $D_x \leq 0.1$	$\pm \frac{E_c}{100}$
Q Accuracy	
@ $ Q_x \tan(E_c/100) < 1$	$\pm \frac{(1 + Q_x^2) \tan(E_c/100)}{1 \mp Q_x \tan(E_c/100)}$
Especially, $\frac{10}{E_c} \geq Q_x \geq 10$	$\pm Q_x^2 \frac{E_c}{100}$
Where,	
D_x : Actual D value of DUT	
E_a, E_b : are as same as E _a and E _b of the measurement accuracy when OPEN/SHORT/50 Ω calibration is done.	
E_c = $0.06 + 0.14 \times \frac{F}{1800}$ (Typical)	
F : measurement frequency [MHz]	
Q_x : Actual Q value of DUT	

Permeability Measurements

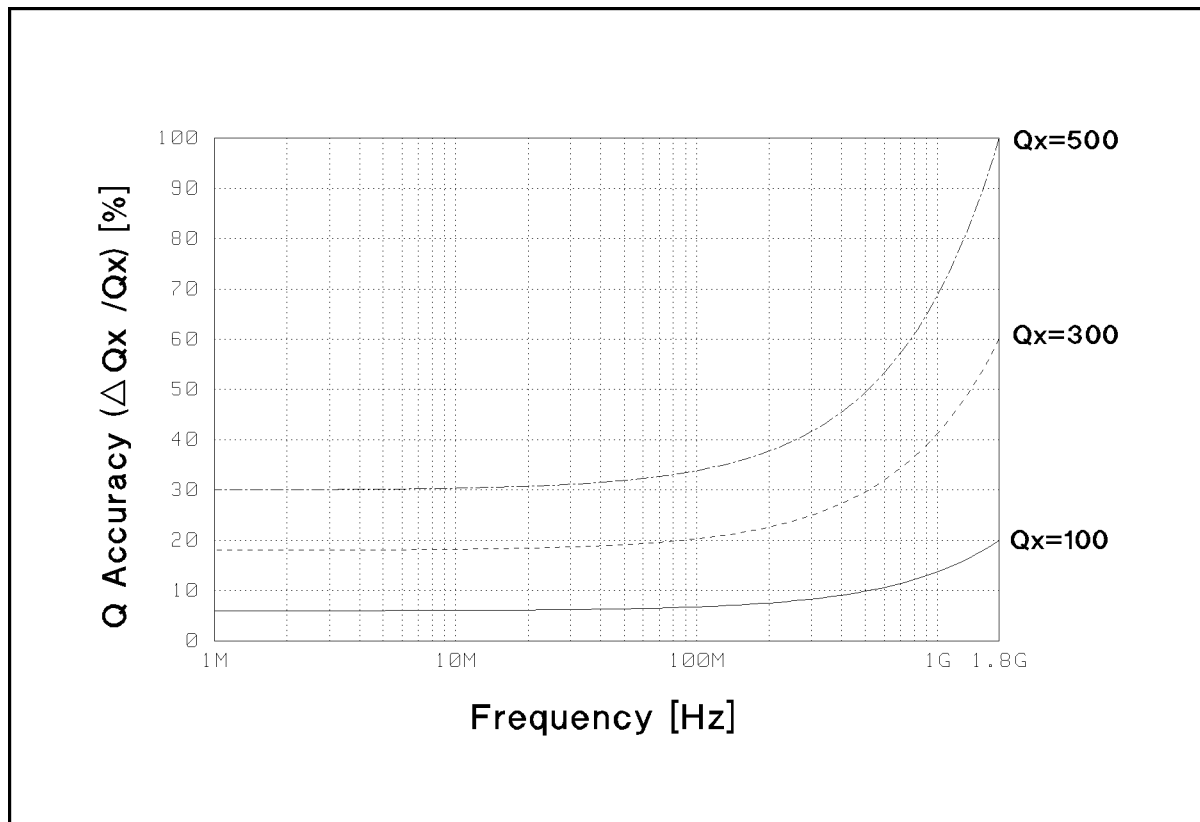

C6600043

Figure 12-6.

Typical Q Measurement Accuracy (when open/short/50 Ω /low-loss-capacitor calibration are done)

Specification for Option 013 and 014 High Temperature Test Heads

Frequency Characteristics

Operating frequency 1 MHz to 1.8 GHz

Source Characteristics

OSC level

Voltage Range

@1 MHz ≤ Frequency < 1 GHz 0.2 mV_{rms} to 500 mV_{rms}

@1 GHz ≤ Frequency ≤ 1.8 GHz 0.2 mV_{rms} 250 mV_{rms}

OSC level resolution

AC voltage resolution

@ 110 mV_{rms} < V_{osc} ≤ 500 mV_{rms} 2 mV

@ 11 mV_{rms} < V_{osc} ≤ 110 mV_{rms} 0.2 mV

@ 1.1 mV_{rms} < V_{osc} ≤ 11 mV_{rms} 20 μV

@ 0.2 mV_{rms} ≤ V_{osc} ≤ 1.1 mV_{rms} 2 μV

AC current resolution

@ 2.75 mA_{rms} < I_{osc} ≤ 12.5 mA_{rms} 50 μA

@ 0.275 mA_{rms} < I_{osc} ≤ 2.75 mA_{rms} 5 μA

@ 27.5 μA_{rms} < I_{osc} ≤ 275 μA_{rms} 0.5 μA

@ 5 μA ≤ I_{osc} ≤ 27.5 μA 0.05 μA

AC power resolution

@ -66.1 dBm ≤ P_{osc} ≤ 1.9 dBm 0.2 dBm max

OSC level accuracy

@ 1 MHz ≤ Frequency ≤ 1GHz, V_{osc} ≤ 0.25 V_{rms} (I_{osc} ≤ 6.3 mA, P_{osc} ≤ -4.1 dBm)

..... $A + B + \frac{8_{[dB]} \times frequency_{[MHz]}}{1800}$ dB

where,

A depends on temperature conditions as follows:

within referenced to 23±5°C 4 dB

@ 0°C to 18°C, 28°C to 40°C 6 dB

B depends on OSC level as follows:

@ 0.5 V_{rms} ≥ V_{osc} ≥ 120 mV_{rms} 0 dB

(12.5 mA_{rms} ≥ I_{osc} ≥ 3mA_{rms})

(1.9 dBm ≥ P_{osc} ≥ -10 dBm)

@ 120 mV_{rms} > V_{osc} ≥ 1.2 mV_{rms} 1 dB

(3 mA_{rms} > I_{osc} ≥ 30 μA_{rms})

(-10 dBm > P_{osc} ≥ -50 dBm)

@ 1.2 mV_{rms} > V_{osc} ≥ 0.2 mV_{rms} 2 dB

(30 μA_{rms} > I_{osc} ≥ 5 μA_{rms})

(-50 dBm > P_{osc} ≥ -66.1 dBm)

Output impedance 40 Ω (Nominal value)

Level Monitor

Monitor accuracy

OSC level Same as OSC level accuracy (typical)

DC bias

.. Twice as bad as specifications of dc level accuracy (typical)

Option 013 and 014 High Temperature Test Heads

Basic Measurement Accuracy

Conditions of accuracy specifications
<ul style="list-style-type: none"> ■ OPEN/SHORT/50 Ω calibration must be done. Calibration ON. ■ Averaging (on point) factor must be larger than 32 at which calibration is done. ■ Measurement points are same as the calibration points. ■ Environment temperature is within ±5°C of temperature at which calibration is done, and within 13°C to 33°C. Beyond this environmental temperature condition, and within 0°C to 40°C, accuracy is twice as bad as specified. ■ Bending cable should be smooth and the bending angle is less than 30°. ■ Cable position should be kept in the same dposition after calibration measurement. ■ OSC level must be same as level at which calibration is done. ■ OSC level is less than or equal to 0.25 V, or OSC level is greater than 0.25 V and frequency range is within 1 MHz to 1 GHz.

$$|Z| \text{ Accuracy} \dots\dots\dots \pm(E_a + E_b) [\%]$$

$$\theta \text{ Accuracy} \dots\dots\dots \pm \frac{(E_a + E_b)}{100} [\text{rad}]$$

Where,

E_a : depends on measurement frequency as follows:

@ 1 MHz ≤ frequency ≤ 100 MHz 0.6 [%]

@ 100 MHz < frequency ≤ 500 MHz 0.8 [%]

@ 500 MHz < frequency ≤ 1 GHz 1.5 [%]

@ 1 GHz < frequency ≤ 1.8 GHz 3.0 [%]

E_b = $(Z_s/Z_x + Y_0 Z_x) \times 100$ [%]

Z_s and **Y₀** depend on number of point averaging (**N_{av}**) and OSC level (**V_{osc}**) as follows:

Z_x : Impedance measurement value [Ω]

Option 013 and 014 High Temperature Test Heads

Table 12-3. Z_s and Y_o when High Impedance Test Head is used

Measurement Conditions		Z_s [Ω]	Y_o [S]
Number of Point Averaging (N_{av})	OSC Signal Level (V_{osc}) ¹		
$1 \leq N_{av} \leq 7$	$V_{osc} < 0.02$	$\frac{0.02}{V_{osc}} \times (0.2 + 0.001 \times f_{[MHz]})$	$\frac{0.02}{V_{osc}} \times (5 \times 10^{-5} + 2 \times 10^{-7} \times f_{[MHz]})$
	$0.02 \text{ V} \leq V_{osc} < 0.12$	$0.2 + 0.001 \times f_{[MHz]}$	$5 \times 10^{-5} + 2 \times 10^{-7} \times f_{[MHz]}$
	$0.12 \text{ V} \leq V_{osc}$	$0.2 + 0.001 \times f_{[MHz]}$	$3 \times 10^{-5} + 2 \times 10^{-7} \times f_{[MHz]}$
$8 < N_{av}$	$V_{osc} < 0.02$	$\frac{0.02}{V_{osc}} \times (0.1 + 0.001 \times f_{[MHz]})$	$\frac{0.02}{V_{osc}} \times (2 \times 10^{-5} + 2 \times 10^{-7} \times f_{[MHz]})$
	$0.02 \text{ V} \leq V_{osc} < 0.12$	$0.1 + 0.001 \times f_{[MHz]}$	$2 \times 10^{-5} + 2 \times 10^{-7} \times f_{[MHz]}$
	$0.12 \text{ V} \leq V_{osc}$	$0.1 + 0.001 \times f_{[MHz]}$	$1 \times 10^{-5} + 2 \times 10^{-7} \times f_{[MHz]}$

¹ $V_{osc} = 0.12 \text{ V} \equiv I_{osc} = 3 \text{ mA} \equiv P_{osc} = -10 \text{ dBm}$, $V_{osc} = 0.02 \text{ V} \equiv I_{osc} = 0.5 \text{ mA} \equiv P_{osc} = -26 \text{ dBm}$

Table 12-4. Z_s and Y_o when Low Impedance Test Head is used

Measurement Conditions		Z_s [Ω]	Y_o [S]
Number of Point Averaging (N_{av})	OSC Signal Level (V_{osc}) ¹		
$1 \leq N_{av} \leq 7$	$V_{osc} < 0.02$	$\frac{0.02}{V_{osc}} \times (0.1 + 0.001 \times f_{[MHz]})$	$\frac{0.02}{V_{osc}} \times (1 \times 10^{-4} + 2 \times 10^{-7} \times f_{[MHz]})$
	$0.02 \text{ V} \leq V_{osc} < 0.12$	$0.1 + 0.001 \times f_{[MHz]}$	$1 \times 10^{-4} + 2 \times 10^{-7} \times f_{[MHz]}$
	$0.12 \text{ V} \leq V_{osc}$	$0.05 + 0.001 \times f_{[MHz]}$	$1 \times 10^{-4} + 2 \times 10^{-7} \times f_{[MHz]}$
$8 < N_{av}$	$V_{osc} < 0.02$	$\frac{0.02}{V_{osc}} \times (0.05 + 0.001 \times f_{[MHz]})$	$\frac{0.02}{V_{osc}} \times (3 \times 10^{-5} + 2 \times 10^{-7} \times f_{[MHz]})$
	$0.02 \text{ V} \leq V_{osc} < 0.12$	$0.05 + 0.001 \times f_{[MHz]}$	$3 \times 10^{-5} + 2 \times 10^{-7} \times f_{[MHz]}$
	$0.12 \text{ V} \leq V_{osc}$	$0.03 + 0.001 \times f_{[MHz]}$	$3 \times 10^{-5} + 2 \times 10^{-7} \times f_{[MHz]}$

¹ $V_{osc} = 0.12 \text{ V} \equiv I_{osc} = 3 \text{ mA} \equiv P_{osc} = -10 \text{ dBm}$, $V_{osc} = 0.02 \text{ V} \equiv I_{osc} = 0.5 \text{ mA} \equiv P_{osc} = -26 \text{ dBm}$

At the following frequency points, instrument spurious characteristics could occasionally cause measurement errors to exceed specified value because of instrument spurious characteristics.

10.71 MHz	17.24 MHz	21.42 MHz	42.84 MHz
514.645 MHz	686.1933 MHz	1029.29 MHz	1327.3866 MHz

See "EMC" under "Others" in "General Characteristics".

The excessive vibration and shock could occasionally cause measurement errors to exceed specified value.

Option 013 and 014 High Temperature Test Heads

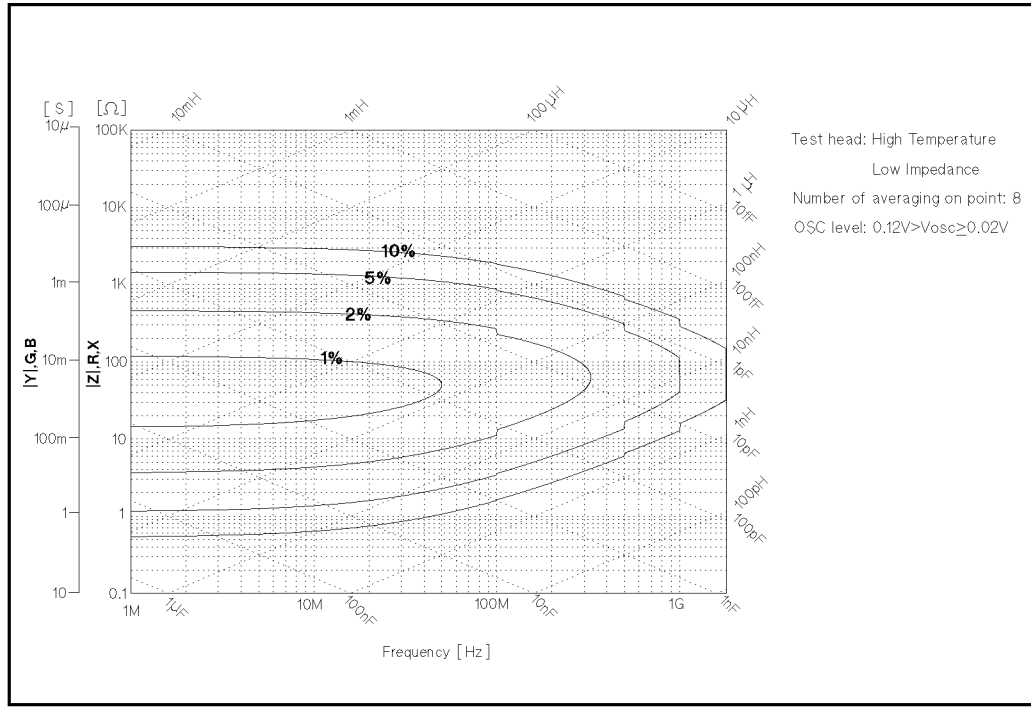

C6600048

Figure 12-9.
Impedance Measurement Accuracy Using High Temperature Low Impedance Test Head
(@ Low OSC Level)

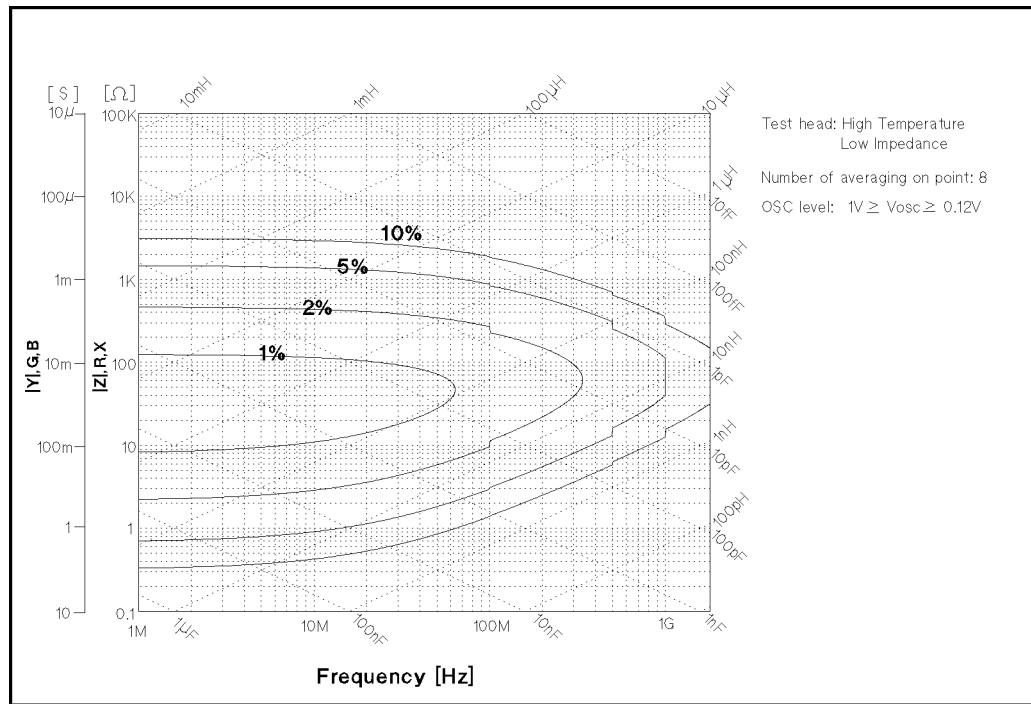

C6600038

Figure 12-10.
Impedance Measurement Accuracy Using High Temperature Low Impedance Test Head
(@ High OSC Level)

Option 013 and 014 High Temperature Test Heads

Typical Effects of Temperature Drift on Measurement Accuracy

When environment temperature is without $\pm 5^{\circ}\text{C}$ of temperature at which calibration is done, add the following measurement error.

Conditions of Typical Effects of Temperature Drift
<ul style="list-style-type: none"> ■ Environment temperature of a test head is within -55°C to 0°C or 40°C to 200°C. ■ Environment temperature of the mainframe is within $\pm 5^{\circ}\text{C}$ of temperature at which calibration is done, and within 0°C to 40°C. ■ Other conditions are as same as the conditions of the basic measurement accuracy of option 013/014.

|Z| Accuracy $\pm(E_{a2} + E_{b2})$ [%]
 θ Accuracy $\pm \frac{(E_{a2} + E_{b2})}{100}$ [rad]

where,

$E_{a2} = (\Delta A_1 \Delta T + \Delta A_2) \times 10^8$
 $E_{b2} = (Z_{s2} / Z_x + Y_{o2} Z_x) \times 100$

ΔA_1 is the effect of temperature drift on the impedance measurement value as follows:

..... $(50 + 300 \times f)$ [ppm/ $^{\circ}\text{C}$] (typical)

ΔA_2 is the hysteresis of the effect of temperature drift on the impedance measurement value as follows:

..... $\frac{\Delta A_1 \Delta T}{3}$ [ppm] (typical)

f : Measurement Frequency [GHz]

ΔT : Difference of temperature between measurement condition and calibration measurement condition. [$^{\circ}\text{C}$]

$Y_{o2} = (\Delta Y_{o1} \Delta T + \Delta Y_{o2}) \times 10^{-6}$ [S]

$Z_{s2} = (\Delta Z_{s1} \Delta T + \Delta Z_{s2}) \times 10^{-3}$ [Ω]

Z_x : Impedance measurement value [Ω]

ΔY_{o1} is the temperature coefficient for OPEN residual as follows:

@ High Temperature High Impedance Test Head is used

..... $(0.2 + 8 \times f^2)$ [$\mu\text{S}/^{\circ}\text{C}$] (typical)

@ High Temperature Low Impedance Test Head is used

..... $(1 + 30 \times f)$ [$\mu\text{S}/^{\circ}\text{C}$] (typical)

ΔY_{o2} is the hysteresis of the OPEN residual as follows:

..... $\frac{\Delta Y_{o1} \Delta T}{3}$ [$\mu\text{S}/^{\circ}\text{C}$] (typical)

ΔZ_{s1} is the temperature coefficient for SHORT residual as follows:

@ High Temperature High Impedance Test Head is used

..... $(4 + 50 \times f)$ [$\text{m}\Omega/^{\circ}\text{C}$] (typical)

@ High Temperature Low Impedance Test Head is used

..... $(1 + 10 \times f^2)$ [$\text{m}\Omega/^{\circ}\text{C}$] (typical)

ΔZ_{s2} is the hysteresis of the SHORT residual as follows:

..... $\frac{\Delta Z_{s1} \Delta T}{3}$ [$\text{m}\Omega/^{\circ}\text{C}$] (typical)

Option 013 and 014 High Temperature Test Heads

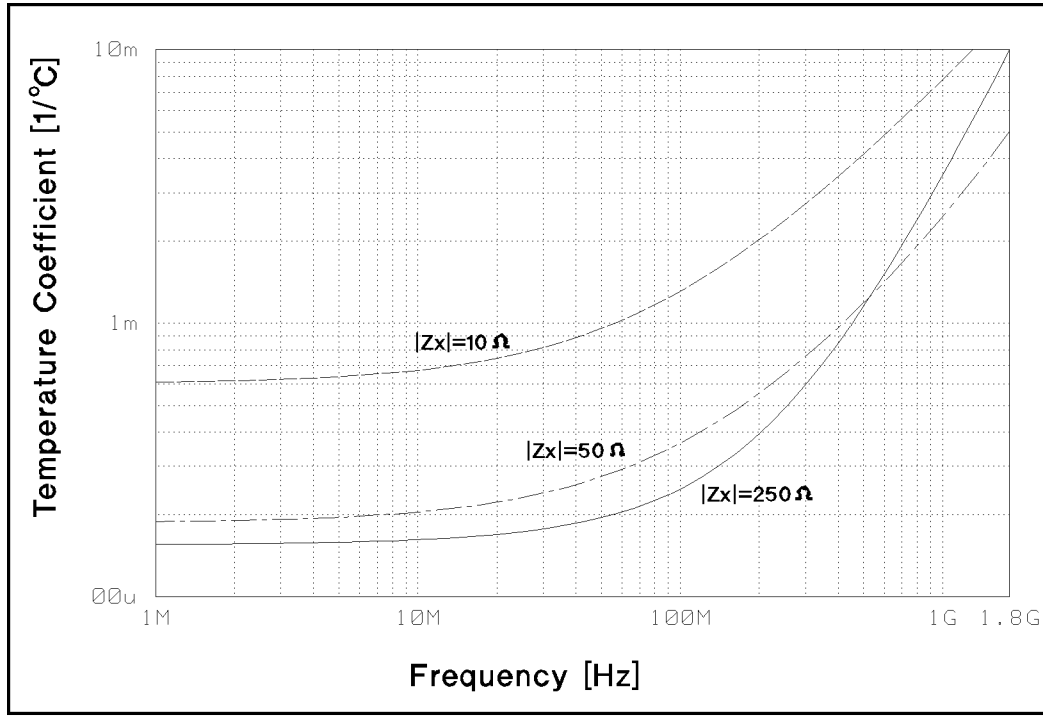

Figure 12-11.
Typical Frequency Characteristics of Temperature Coefficient Using High Temperature High Impedance Test Head

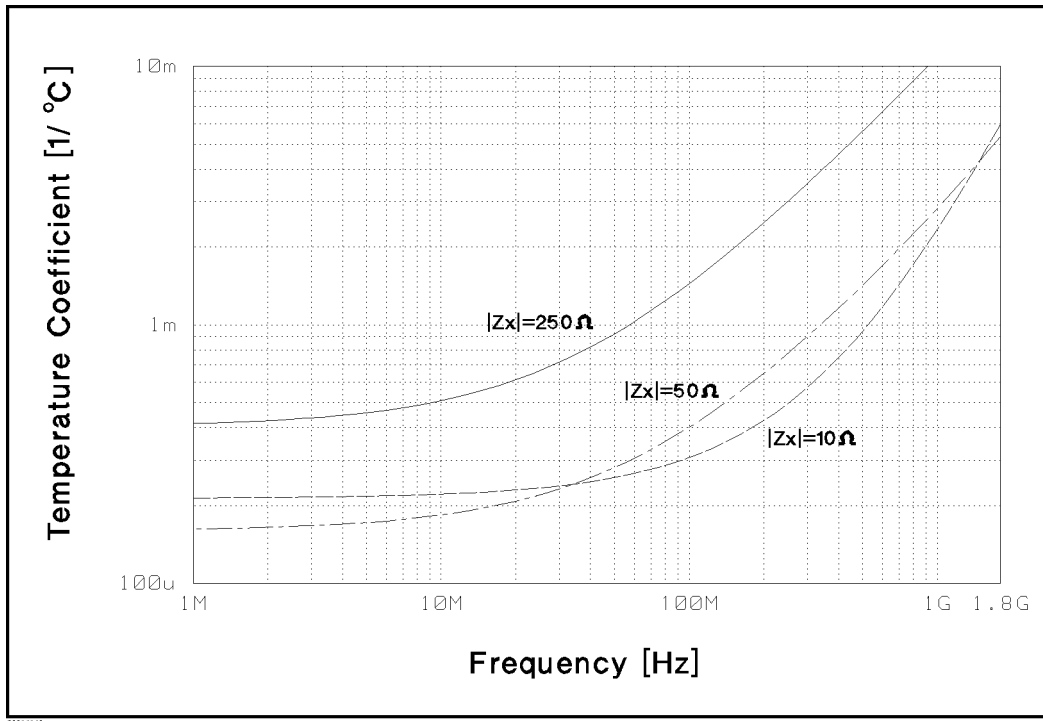

Figure 12-12.
Typical Frequency Characteristics of Temperature Coefficient Using High Temperature Low Impedance Test Head

Option 013 and 014 High Temperature Test Heads

Operation Conditions of the Test Head

The cable at least 15 cm from the test station must be in the same temperature of the main frame.

.....-55°C to +200°C

Dimensions of High Temperature Test Head

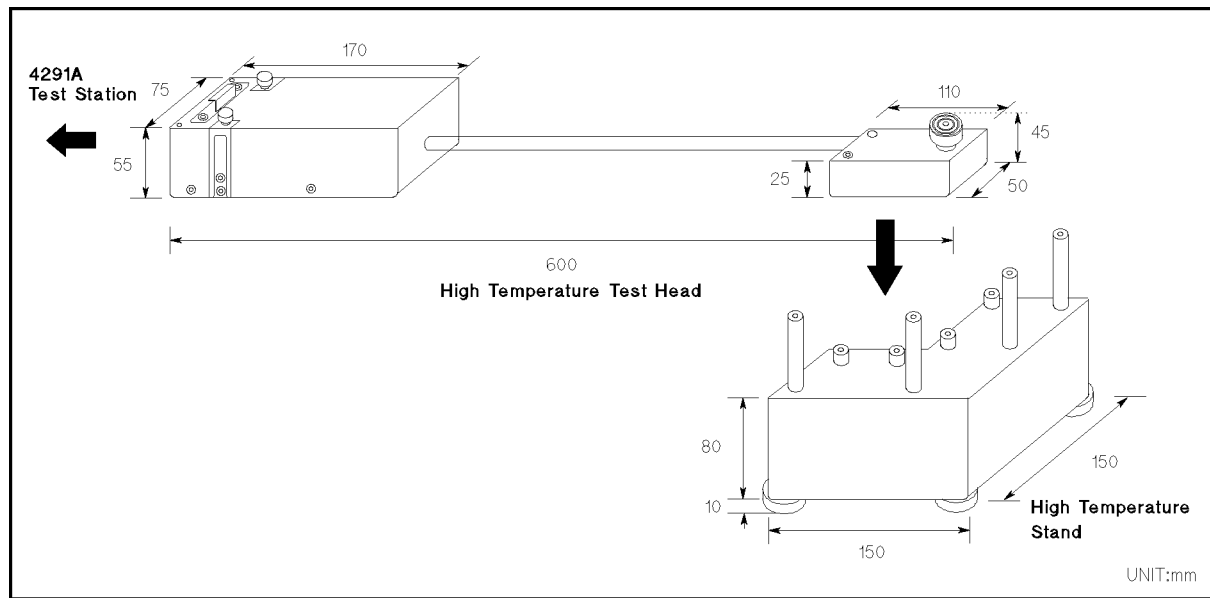

Figure 12-13. Dimensions of High Temperature Test Head

Display

LCD	
type/size	Color TFT, 8.4 inch
Resolution	640 × 480
Effective Display Area	160 mm × 115mm (600 × 430 dots)
Number of display channels	2
Format	single, dual split or overwrite, graphic, and tabular
Number of traces	
For measurement	1 trace/channel
For memory	16 traces/channel (maximum)
Data math functions	gain × data – offset gain × memory – offset gain × (data – memory) – offset gain × (data + memory) – offset gain × (data/memory) – offset gain × (data×memory) – offset
Marker	
Number of markers	
Main marker	1 for each channel
Sub-marker	7 for each channel
ΔMarker	1 for each channel

Data Storage

Type	floppy disk drive, Volatile memory disk
Capacity	
floppy disk	720 kB/1.44 MB
Volatile memory disk, can be backed up by flash memory (maximum)	.448 kB
Disk format	LIF, DOS

GPIB

Interface	IEEE 488.1-1987, IEC625,
Interface function	SH1, AH1, T6, TE0, L4, LE0, SR1, RL1, PPO, DC1, DT1, C1, C2, C3, C4, C11, E2
Numeric Data Transfer formats	ASCII 32 and 64 bit IEEE 754 Floating point format, DOS PC format (32 bit IEEE with byte order reversed)
Protocol	IEEE 488.2-1987

Printer parallel port

Interface IEEE 1284 Centronics standard compliant
Printer control language HP PCL3 Printer Control Language
Connector D-sub (25-pin)

General Characteristics

Input and Output Characteristics

External reference input

Frequency 10 MHz \pm 100 Hz (typically)
Level > -6 dBm (typically)
Input impedance 50 Ω (nominal)
Connector BNC female

Internal Reference Output

Frequency 10 MHz (nominal)
Level 2 dBm (typically)
Output Impedance 50 Ω (nominal)
Connector BNC female

External trigger input

Level TTL Level
Pulse width (Tp) > 2 μ s (typically)
Polarity positive/negative selective
Connector BNC female

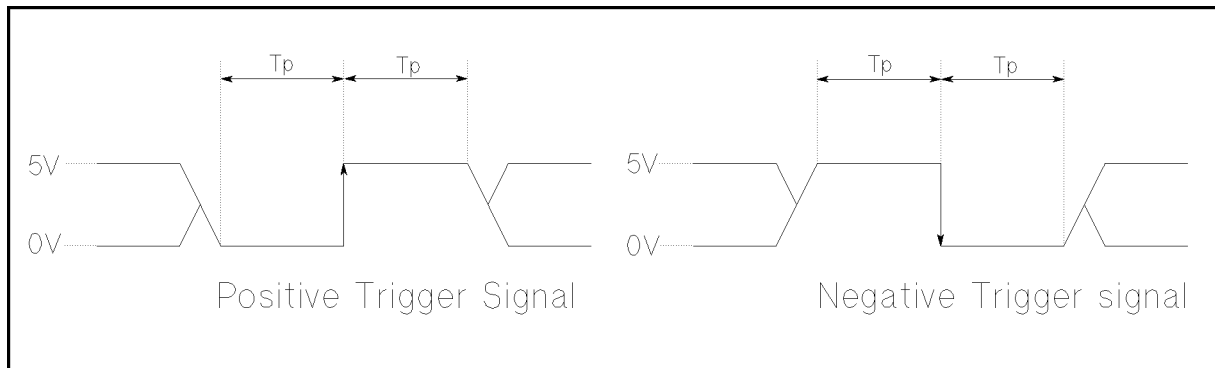

Figure 12-14. Trigger Signal

External monitor output

Connector D-sub (15-pin HD)
Display resolution 640 \times 480 VGA

Option 013 and 014 High Temperature Test Heads

Operation Conditions

Temperature

Disk drive non-operating condition 0°C to 40°C
Disk drive operating condition 10°C to 40°C

Humidity

@wet bulb temperature <29°C, without condensation
Disk drive non-operating condition 15 % to 95 % RH
Disk drive operating condition 15 % to 80 % RH

Altitude 0 to 2,000 meters

Warm up time 30 minutes

Non-operation conditions

Temperature -20°C to 60°C

Humidity

@wet bulb temperature <45°C, without condensation .15 % to 95 % RH

Altitude 0 to 4,572 meters

Others

EMC

Complies with CISPR 11 (1990) / EN 55011 (1991) : Group 1, Class A

Complies with IEC 1000-3-2 (1995) / EN 61000-3-2 (1995)

Complies with IEC 1000-3-3 (1994) / EN 61000-3-3 (1995)

Complies with IEC 1000-4-2 (1995) / EN 50082-1 (1992) : 4 kV CD, 8 kV AD

Complies with IEC 1000-4-3 (1995) / EN 50082-1 (1992) : 3 V/m, 27-1000 MHz

Complies with IEC 1000-4-4 (1995) / EN 50082-1 (1992) : 0.5 kV Signal Lines, 1 kV Main

Note: When tested at 3 V/m according to IEC 1000-4-3(1995), the measurement accuracy will be within specifications over the full immunity test frequency range of 27 to 1000 MHz except when the analyzer frequency is identical to the transmitted interference signal test frequency.

This ISM device complies with Canadian ICES-001. Cet appareil ISM est conforme à la norme NMB-001 du Canada.

Safety

Complies with IEC 1010-1(1990), Amendment1(1992) and Amendment2(1995).

Complies with CSA-C22.2 No.1010.1-92.

Power requirements

90V to 132V, or 198V to 264V (automatically switched), 47 to 63 Hz, 300VA max

Weight

Mainframe 21.5 kg (SPC)

Test Station 3.7 kg

Dimensions

Mainframe 425 (W) × 235 (H) × 553 (D) mm

Test Station 275 (W) × 95 (H) × 205 (D) mm

Option 013 and 014 High Temperature Test Heads

External program Run/Cont input

Connector BNC female
Level TTL
Keyboard connector mini-DIN
I/O port 4 bit in/ 8 bit out port, TTL Level
I/O port pin assignments

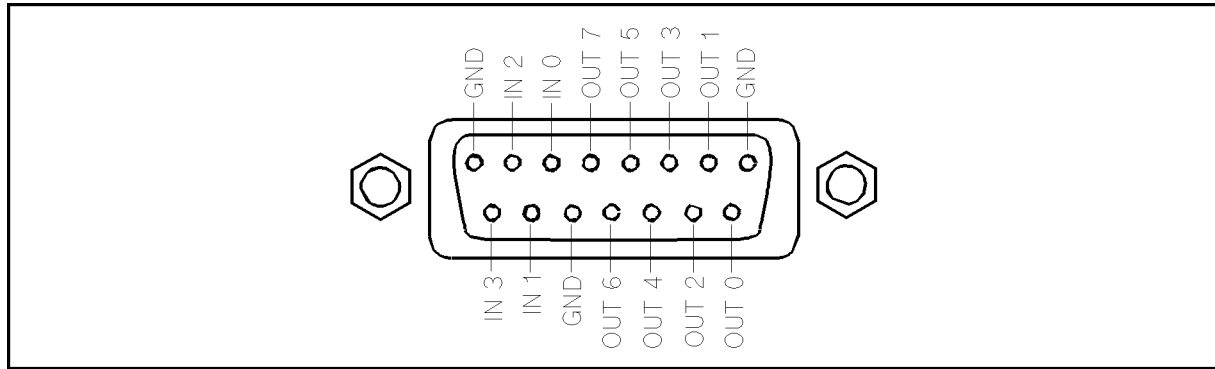

C660001f

Figure 12-15. I/O Port Pin Assignment

Specifications for Option 1D5 High Stability Frequency Reference

Reference Oven Output

Frequency 10 MHz (nominal)
Level 0 dBm (typically)
Output Impedance 50 Ω (nominal)
Connector BNC female

Supplemental Characteristics for Option 002 Material Measurement

Measurement Frequency Range

- @ Using with 16453A 1 MHz to 1.0 GHz (Typical)
- @ Using with 16454A 1 MHz to 1.0 GHz (Typical)

Measurement Parameter

Permittivity parameters

..... $|\epsilon_r|, \epsilon_r', \epsilon_r'', \tan\delta$

Permeability parameters

..... $|\mu_r|, \mu_r', \mu_r'', \tan\delta$

Typical Measurement Accuracy

Conditions of accuracy characteristics
<ul style="list-style-type: none"> ■ Use the High Z Test Head for permittivity measurement ■ Use the Low Z Test Head for permeability measurement ■ OPEN/SHORT/50 Ω calibration must be done. Calibration ON. ■ Averaging (on point) factor is larger than 32 at which calibration is done if Cal points is set to USER DEF. ■ Measurement points are same as the calibration points if Cal point is set to USER DEF. ■ Environment temperature is within ±5°C of temperature at which calibration is done, and within 13°C to 33°C. Beyond this environmental temperature condition, accuracy is twice as bad as specified.

$$\epsilon_r' \text{ Accuracy } \left(\frac{\Delta\epsilon_{rm}'}{\epsilon_{rm}'} \right)$$

@tanδ < 0.1

$$\dots\dots 5 + \left(10 + \frac{0.04}{f} \right) \frac{t}{\epsilon_{rm}'} + 0.25 \frac{\epsilon_{rm}'}{t} + \frac{100}{\left| 1 - \left(\frac{13}{f\sqrt{\epsilon_{rm}'}} \right)^2 \right|} \text{ [%] (Typical)}$$

Loss Tangent Accuracy of ϵ_r (Δtanδ)

@tanδ < 0.1 $E_a + E_b$ (Typical)

Where,

@ frequency ≤ 1 GHz

$$\mathbf{E}_a = 0.002 + \frac{0.0004}{f} \frac{t}{\epsilon_{rm}'} + 0.004f + \frac{0.1}{\left| 1 - \left(\frac{13}{f\sqrt{\epsilon_{rm}'}} \right)^2 \right|}$$

(Typical)

@ frequency > 1 GHz

$$\mathbf{E}_a = 0.002 + \frac{0.0004}{f} \frac{t}{\epsilon_{rm}'} + 0.004f + \frac{1.1}{\left| 1 - \left(\frac{13}{f\sqrt{\epsilon_{rm}'}} \right)^2 \right|}$$

(Typical)

$$\mathbf{E}_b = \left(\frac{\Delta\epsilon_{rm}'}{\epsilon_{rm}'} \frac{1}{100} + \epsilon_{rm}' \frac{0.002}{t} \right) \tan \delta \text{ (Typical)}$$

Option 002 Material Measurement

- f** is measurement frequency [GHz]
- t** is thickness of MUT [mm]
- ϵ_{rm}' is measured value of ϵ_r'
- tan δ** is measured value of dielectric loss tangent

μ_r' Accuracy $\left(\frac{\Delta\mu_{rm}'}{\mu_{rm}'}\right)$

@tan $\delta < 0.1$ $4 + \frac{25}{F\mu_{rm}'} + F\mu_{rm}'\left(1 + \frac{15}{F\mu_{rm}'}\right)^2 f^2$ [%] (Typical)

Loss Tangent Accuracy of μ_r ($\Delta\tan\delta$)

@tan $\delta < 0.1$ $E_a + E_b$ (Typical)

Where,

$E_a = 0.002 + \frac{0.001}{F\mu_{rm}'f} + 0.004f$ (Typical)

$E_b = \frac{\Delta\mu_{rm}' \tan \delta}{\mu_{rm}' 100}$ (Typical)

- f** is measurement frequency [GHz]
- $F = h \ln \frac{c}{b}$ [mm]
- h** is the height of MUT [mm]
- b** is the inner diameter of MUT
- c** is the outer diameter of MUT
- tan δ** is the measured value of loss tangent
- μ_{rm}' is the measured value of permeability

At the following frequency points, instrument spurious characteristics could occasionally cause measurement errors to exceed specified value because of instrument spurious characteristics.			
10.71 MHz	17.24 MHz	21.42 MHz	42.84 MHz
514.645 MHz	686.19333 MHz	1029.29 MHz	1327.38666 MHz

See "EMC" under "Others" in "General Characteristics".

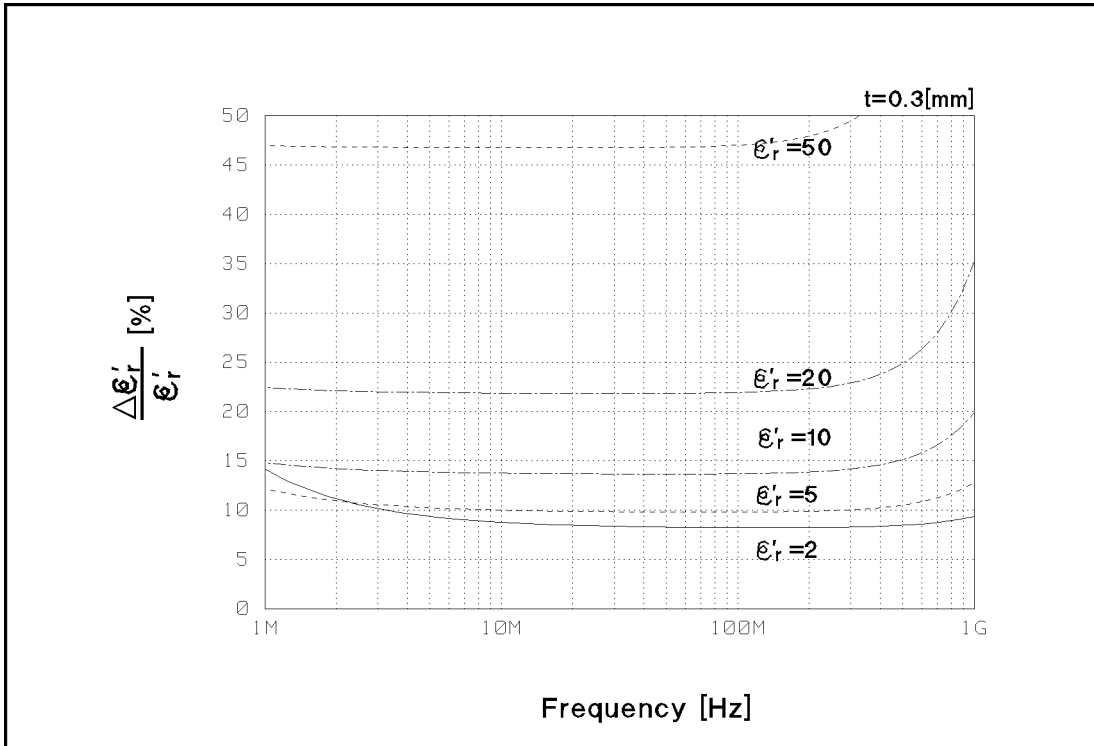

CE001209

Figure 12-16. Typical Permittivity Measurement Accuracy (@thickness = 0.3 mm)

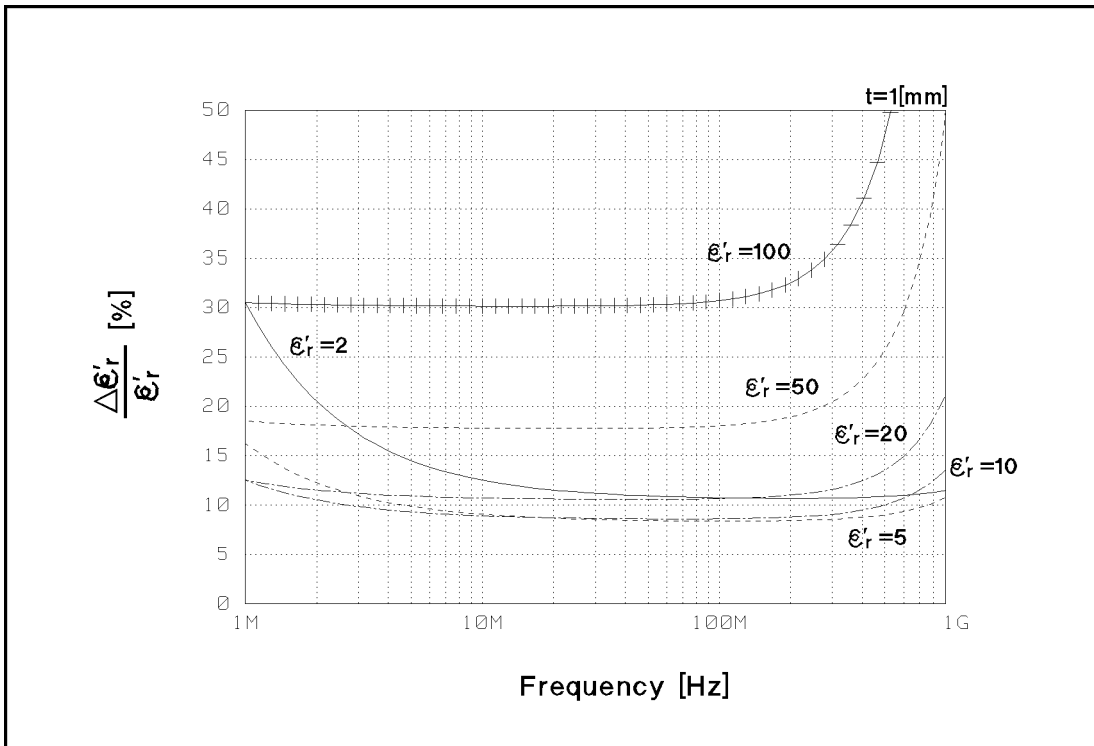

CE001210

Figure 12-17. Typical Permittivity Measurement Accuracy (@thickness = 1 mm)

Option 002 Material Measurement

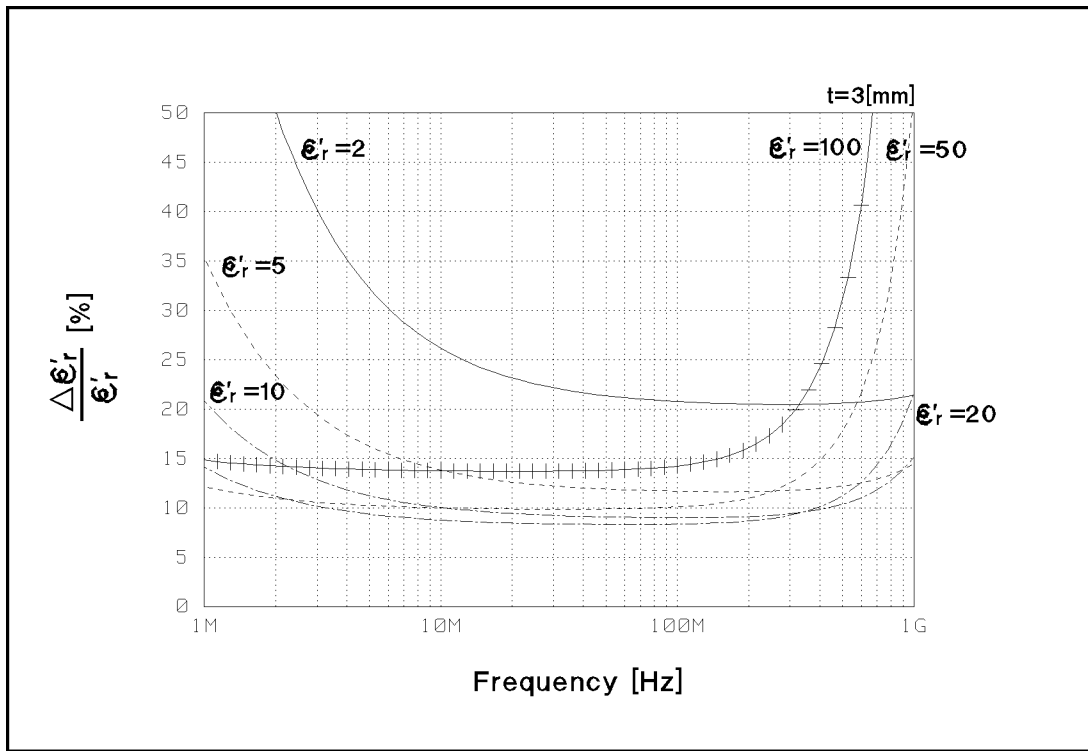

CE001211

Figure 12-18. Typical Permittivity Measurement Accuracy (@thickness = 3 mm)

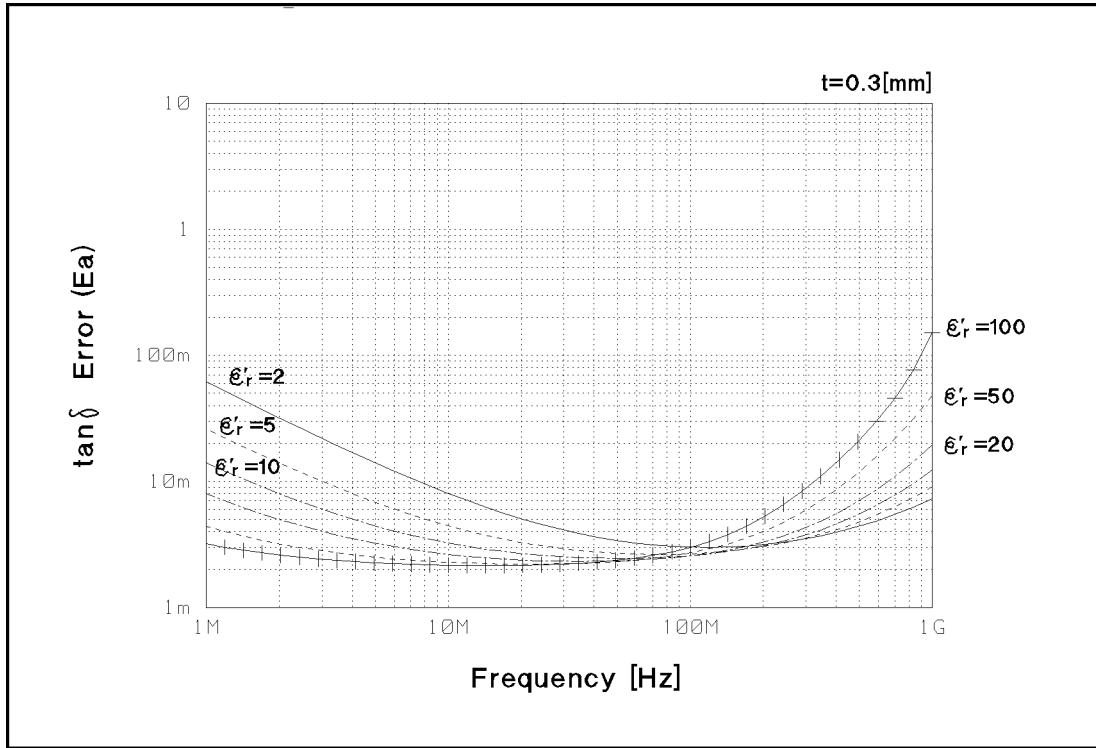

Figure 12-19.
Typical Dielectric Loss Tangent ($\tan \delta$) Measurement Accuracy (@thickness = 0.3 mm)

Note



This graph shows only frequency dependence of E_a to simplify it. The typical accuracy of $\tan \delta$ is defined as $E_a + E_b$; refer to “Supplemental Characteristics for Option 002 Material Measurement”.

Option 002 Material Measurement

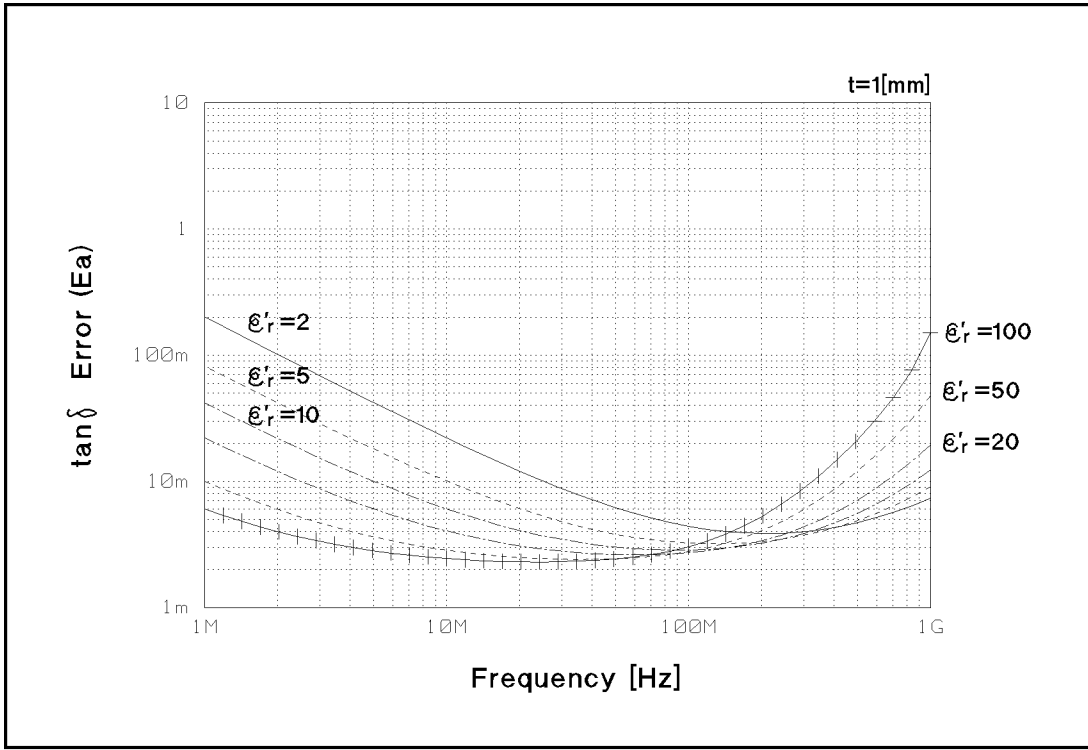

Figure 12-20. Typical Dielectric Loss Tangent ($\tan\delta$) Measurement Accuracy (@thickness = 1 mm)

Note



This graph shows only frequency dependence of E_a to simplify it. The typical accuracy of $\tan\delta$ is defined as $E_a + E_b$; refer to “Supplemental Characteristics for Option 002 Material Measurement”.

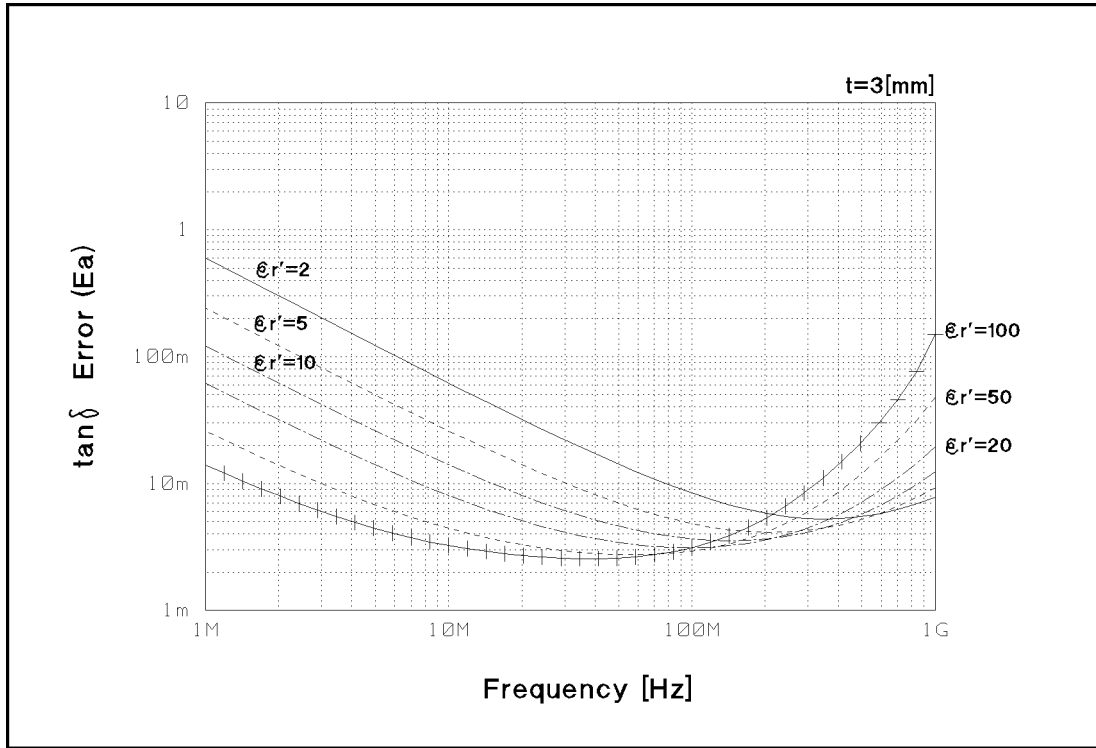

Figure 12-21. Typical Dielectric Loss Tangent ($\tan\delta$) Measurement Accuracy (@thickness = 3 mm)

Note



This graph shows only frequency dependence of E_a to simplify it. The typical accuracy of $\tan\delta$ is defined as $E_a + E_b$; refer to “Supplemental Characteristics for Option 002 Material Measurement”.

Option 002 Material Measurement

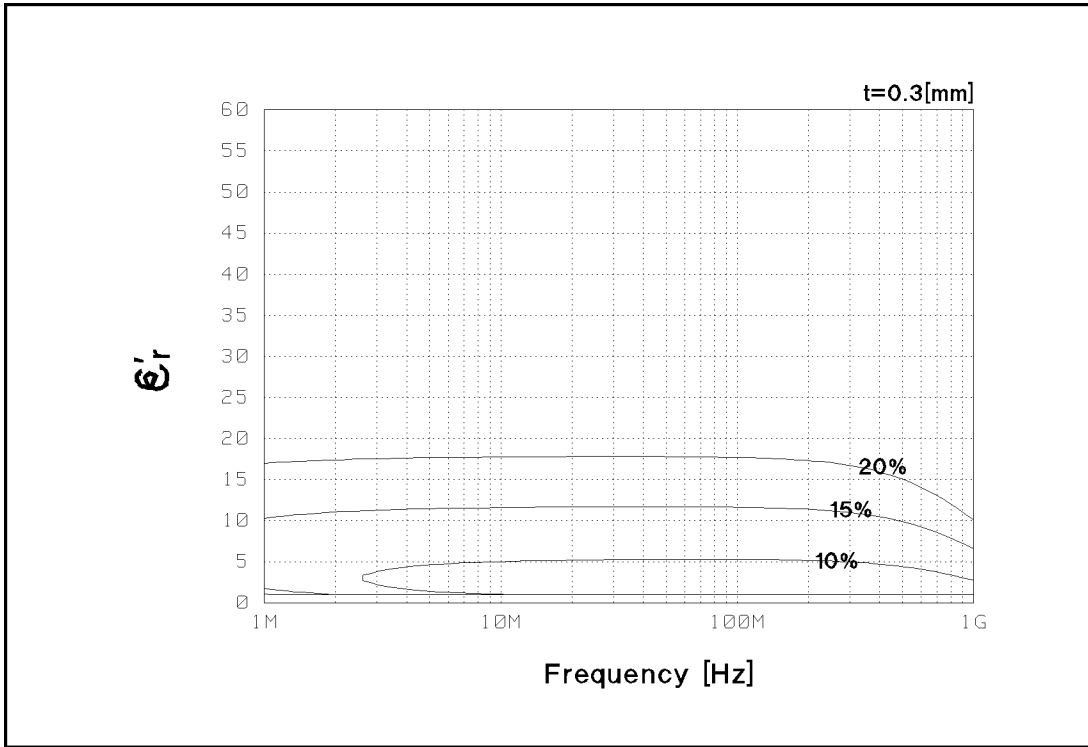

CE001216

Figure 12-22.
Typical Permittivity Measurement Accuracy (ϵ_r v.s. Frequency, @thickness = 0.3 mm)

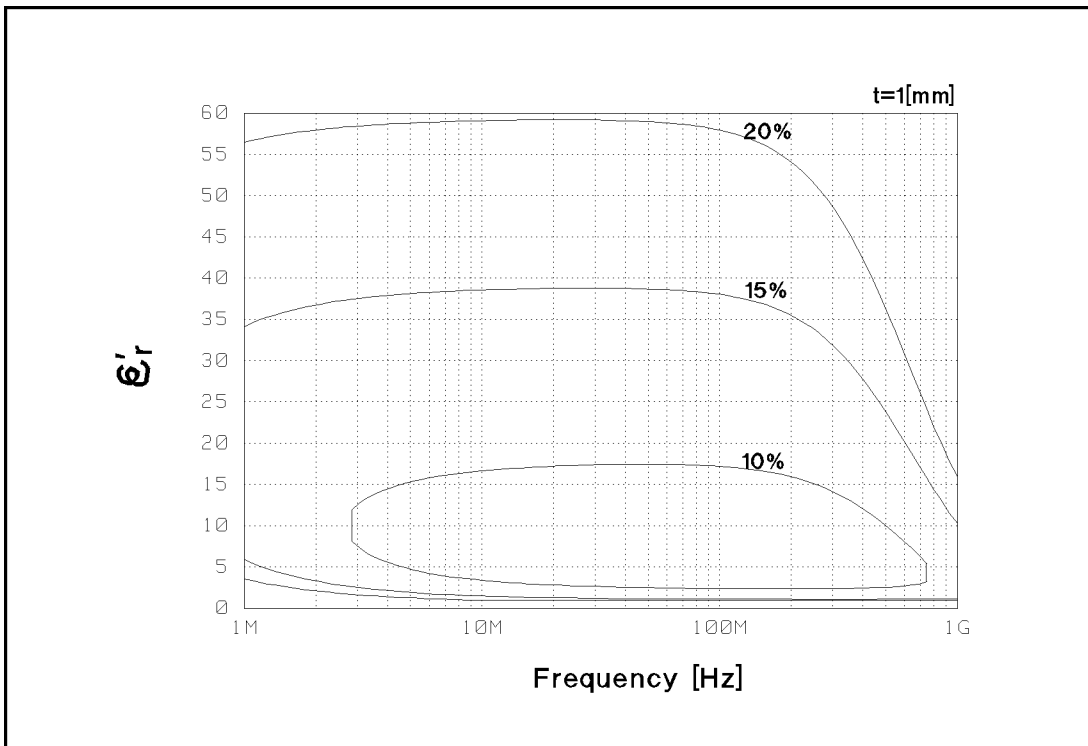

CE001216

Figure 12-23.
Typical Permittivity Measurement Accuracy (ϵ_r v.s. Frequency, @thickness = 1 mm)

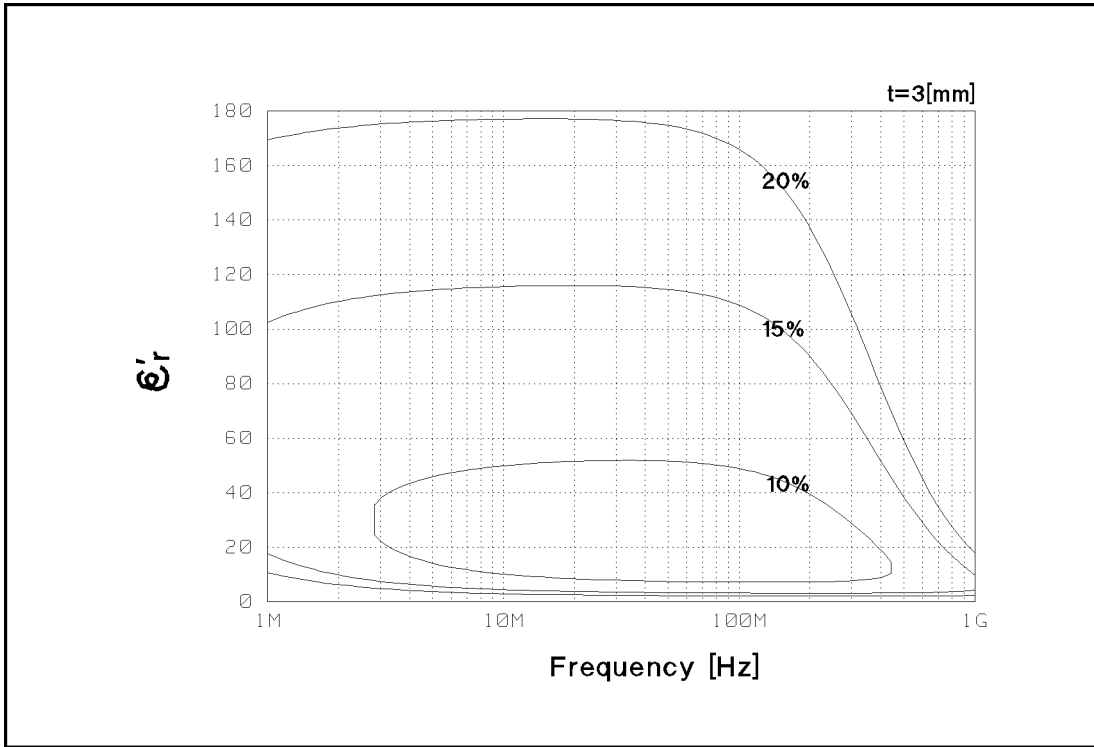

CE001217

Figure 12-24.
Typical Permittivity Measurement Accuracy (ϵ_r v.s. Frequency, @thickness = 3 mm)

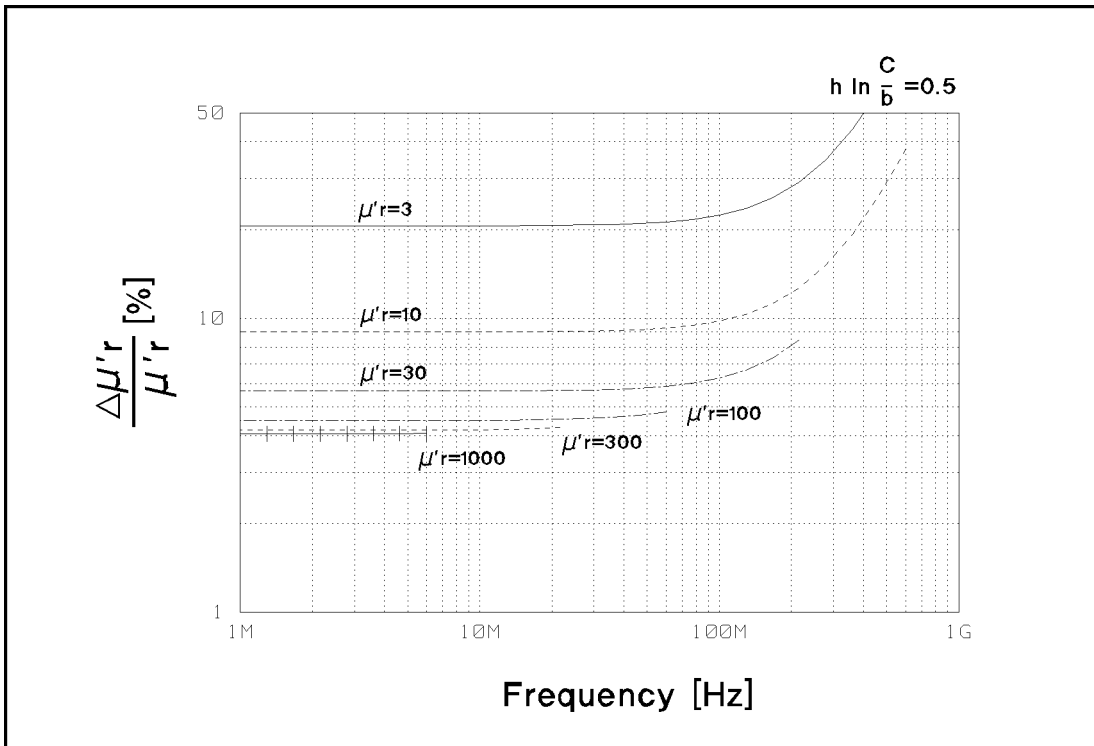

CE001218

Figure 12-25. Typical Permeability Measurement Accuracy (@ $F^* = 0.5$)

Option 002 Material Measurement

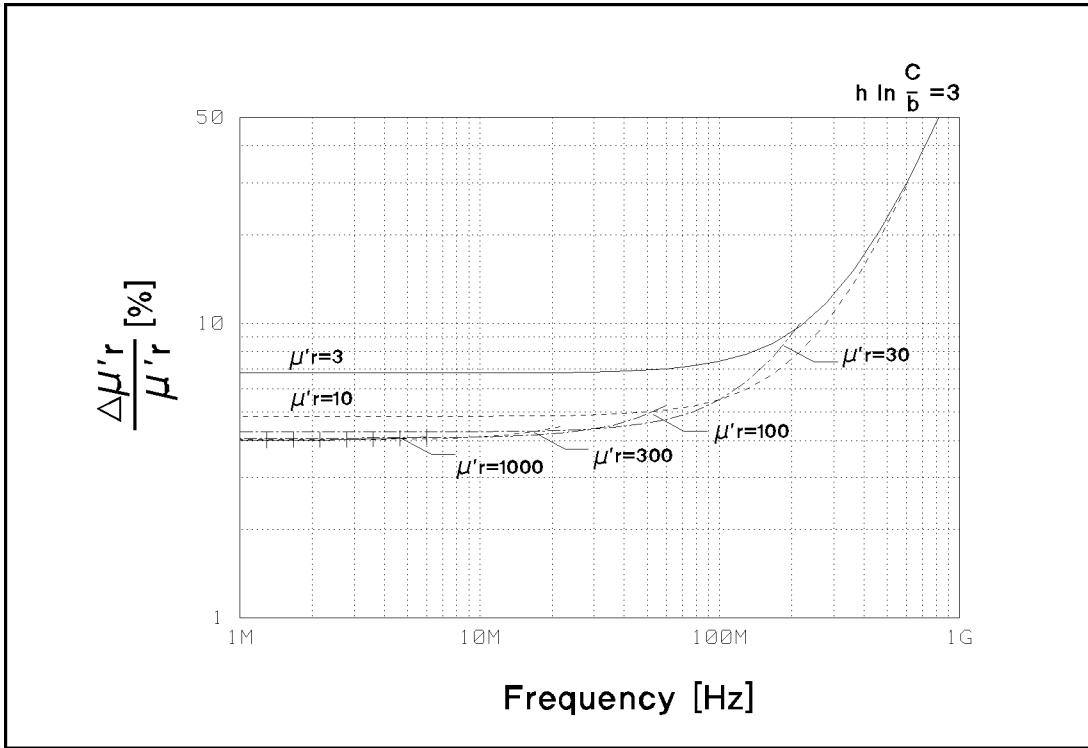

CE001219

Figure 12-26. Typical Permeability Measurement Accuracy (@ $F^* = 3$)

* $F = h \ln \frac{C}{b}$

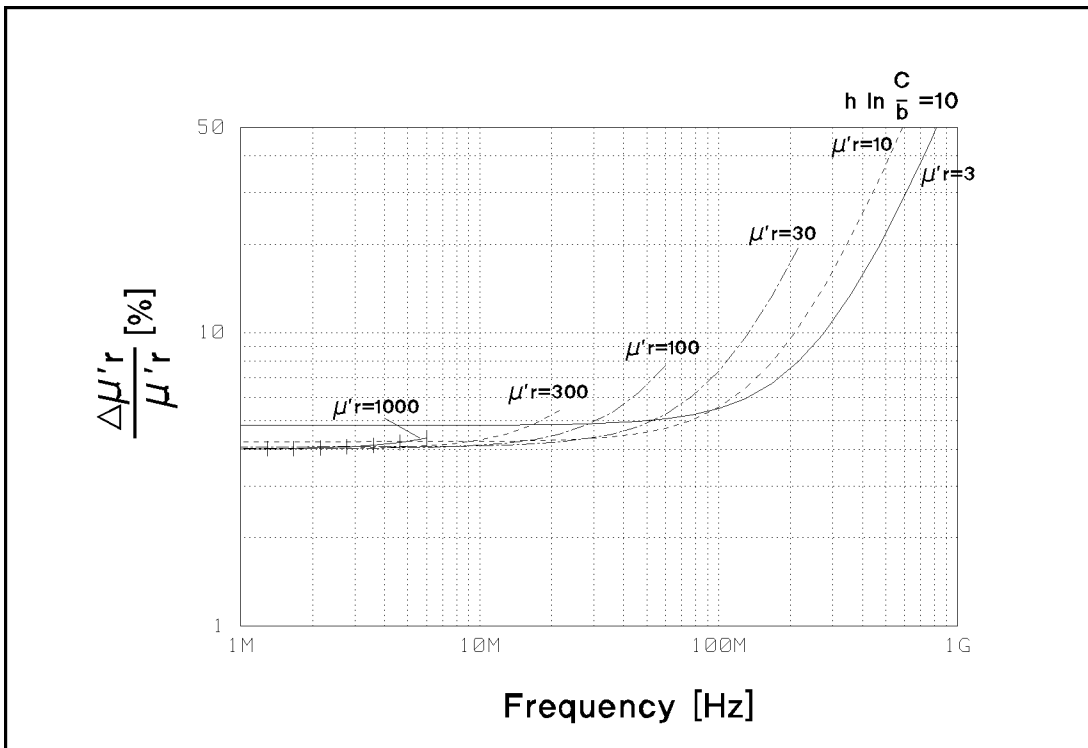

CE001220

Figure 12-27. Typical Permeability Measurement Accuracy (@ $F^* = 10$)

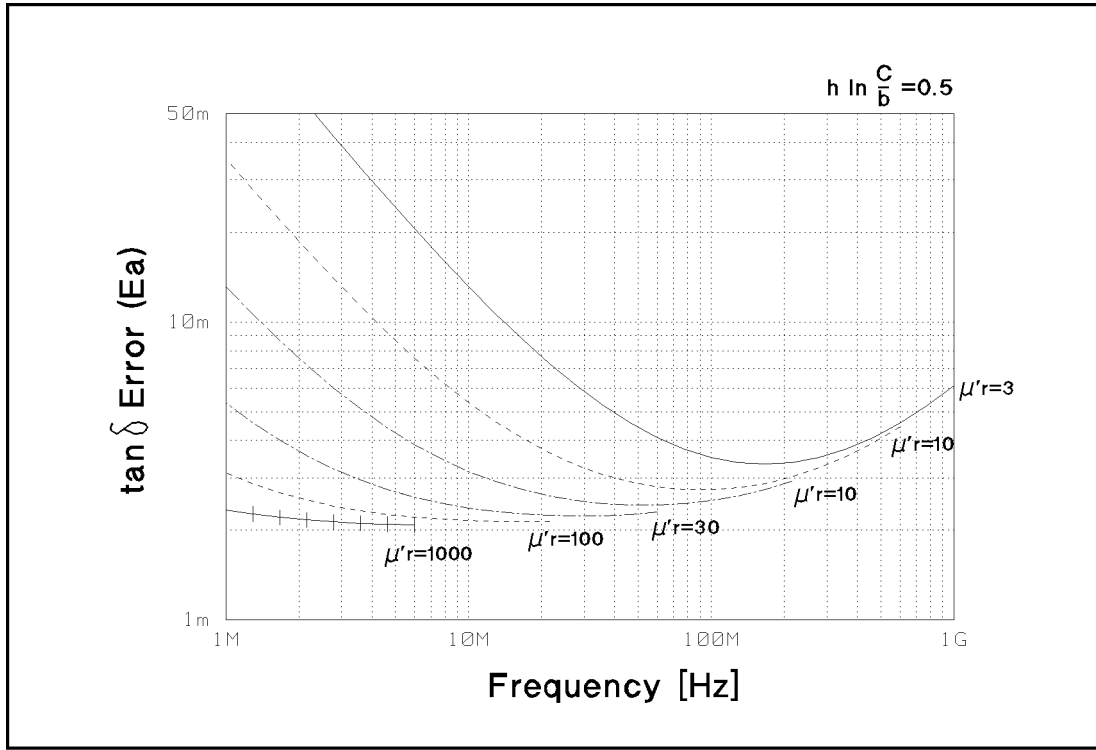

Figure 12-28. Typical Permeability Loss Tangent ($\tan\delta$) Measurement Accuracy (@ $F^* = 0.5$)
 * $F = h \ln \frac{c}{b}$

Note



This graph shows only frequency dependence of E_a to simplify it. The typical accuracy of $\tan\delta$ is defined as $E_a + E_b$; refer to “Supplemental Characteristics for Option 002 Material Measurement”.

Option 002 Material Measurement

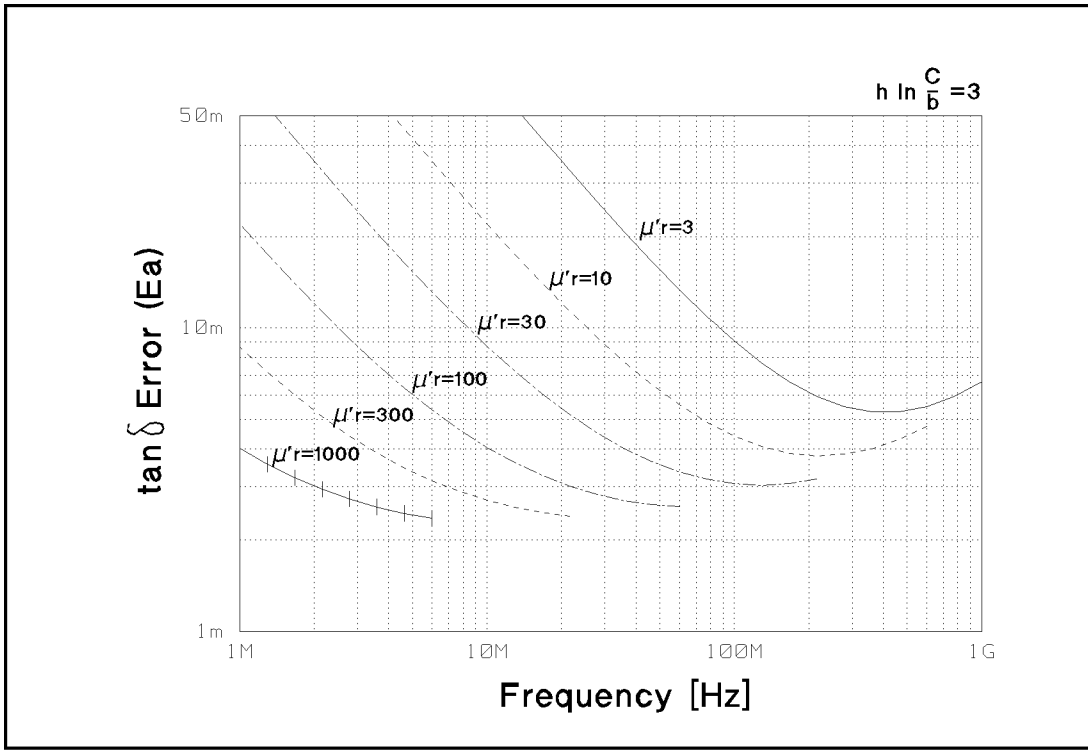

Figure 12-29. Typical Permeability Loss Tangent ($\tan \delta$) Measurement Accuracy (@ $F^* = 3$)

Note



This graph shows only frequency dependence of E_a to simplify it. The typical accuracy of $\tan \delta$ is defined as $E_a + E_b$; refer to “Supplemental Characteristics for Option 002 Material Measurement”.

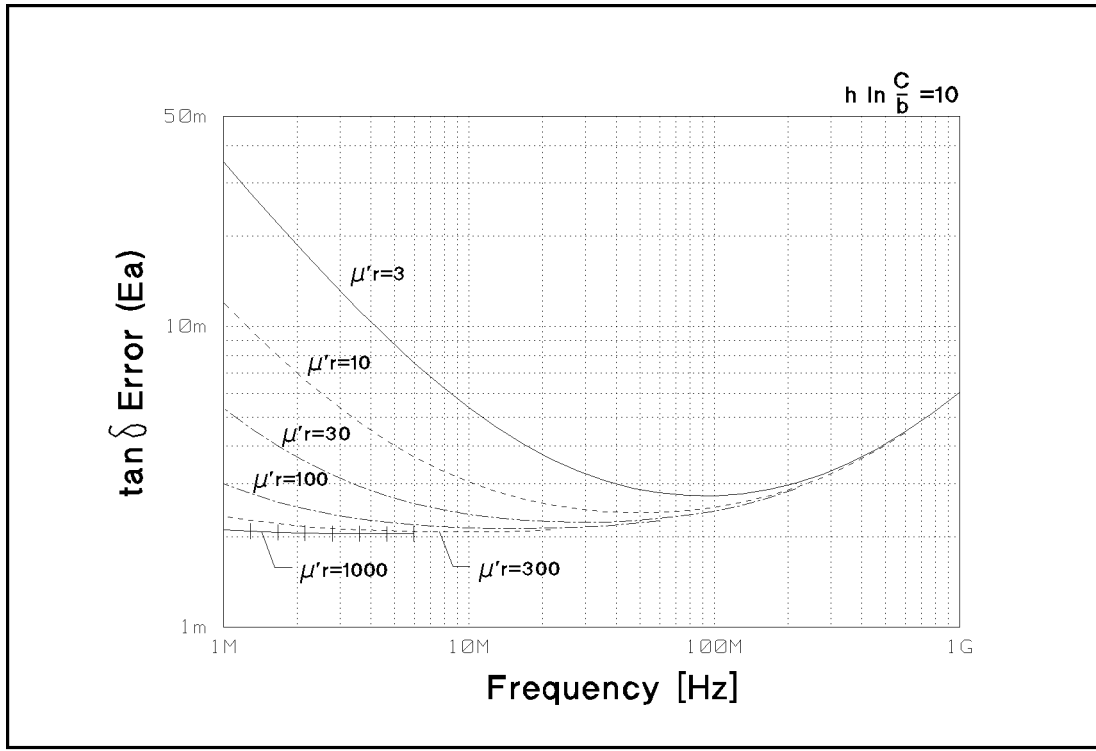

Figure 12-30. Typical Permeability loss Tangent ($\tan \delta$) Measurement Accuracy (@ $F^* = 10$)

* $F = h \ln \frac{C}{b}$

Note



This graph shows only frequency dependence of E_a to simplify it. The typical accuracy of $\tan \delta$ is defined as $E_a + E_b$; refer to “Supplemental Characteristics for Option 002 Material Measurement”.

Option 002 Material Measurement

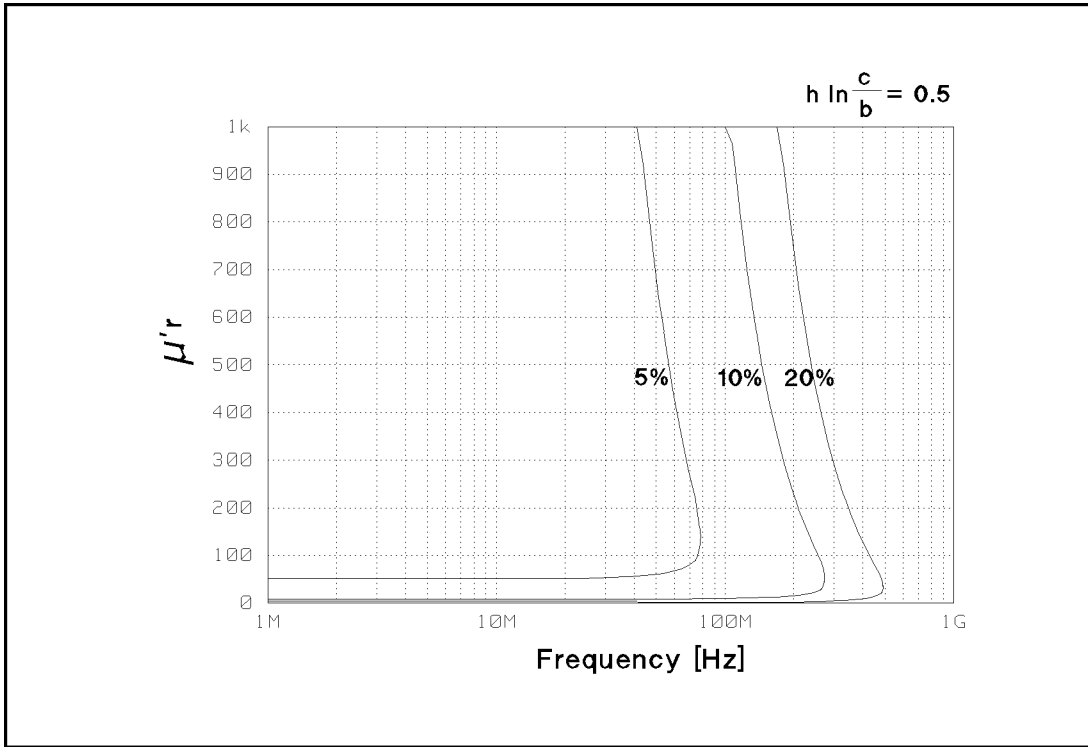

CE001224

Figure 12-31. Typical Permeability Measurement Accuracy (μ_r v.s. Frequency, @ $F^* = 0.5$)

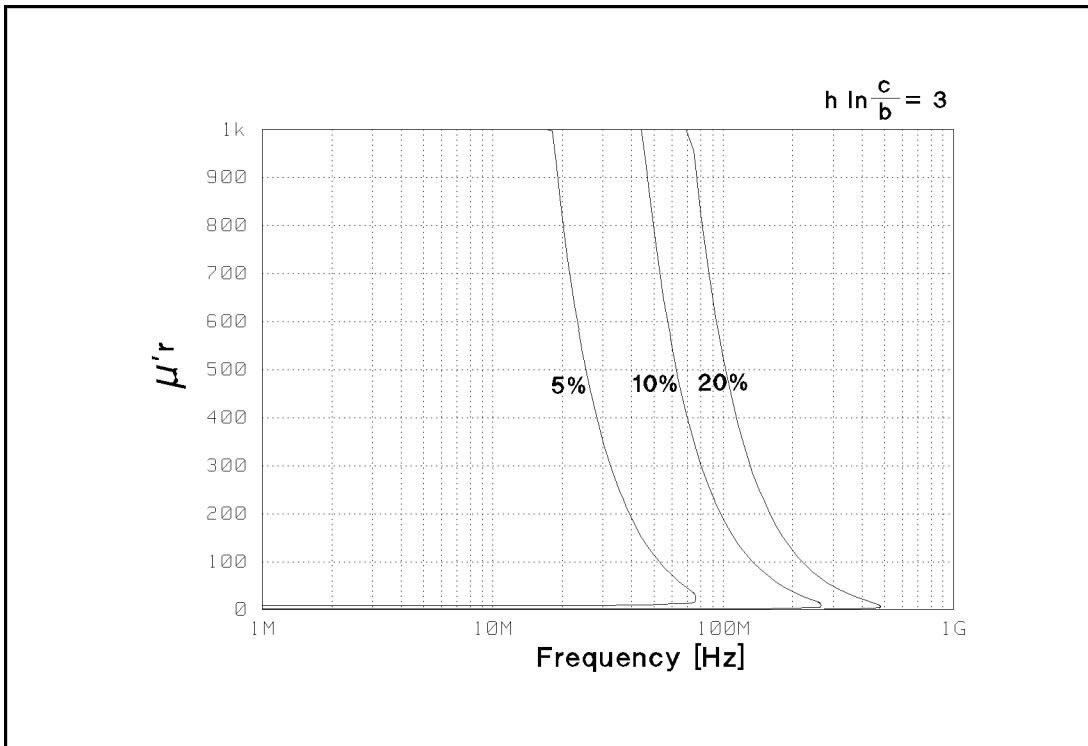

CE001225

Figure 12-32. Typical Permeability Measurement Accuracy (μ_r v.s. Frequency, @ $F^* = 3$)

* $F^* = h \ln \frac{c}{b}$

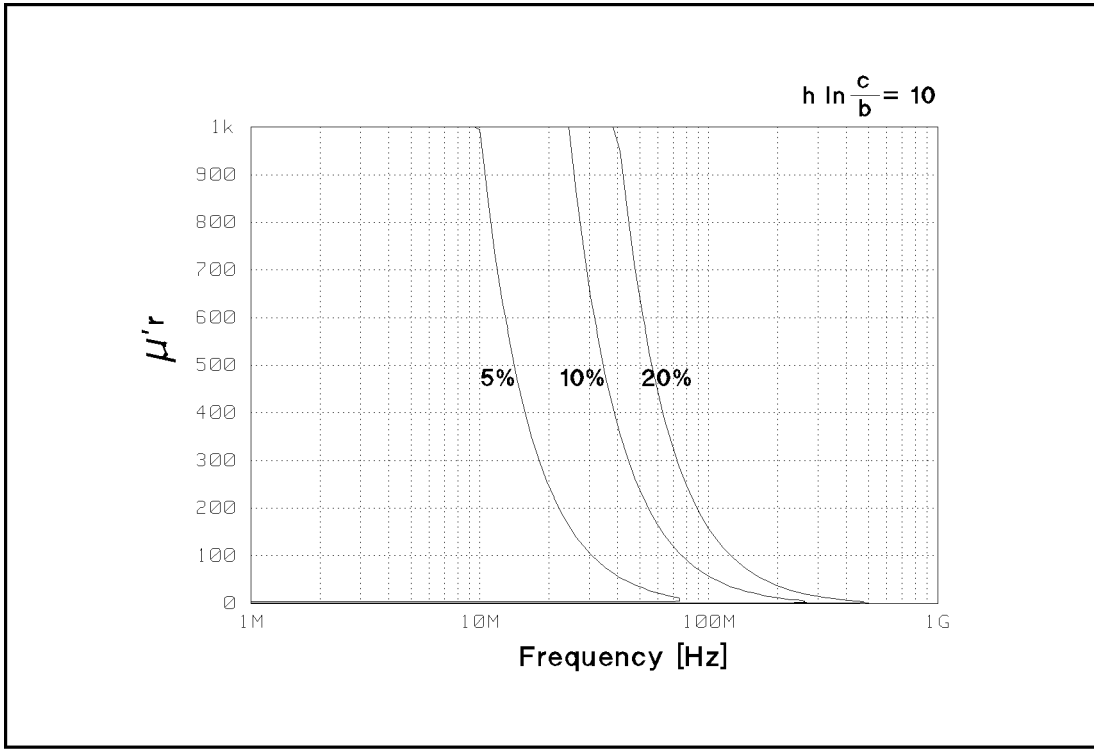

Figure 12-33. Typical Permeability Measurement Accuracy (μ_r v.s. Frequency, @ $F^* = 10$)
 * $F = h \ln \frac{c}{b}$

Option 002 Material Measurement

Applicable MUT (Material Under Test) Size

.....See Table 12-5 and Table 12-6

Maximum DC Bias Voltage / Current

@Using with 16453A ± 40 V

@Using with 16454A ± 500 mA

Operating Temperature

@Using with 16453A or 16454A -55°C to +200°C

Operating Humidity

@ wet bulb temperature <40°C

@Using with 16453A or 16454A up to 95% RH

**Table 12-5.
Applicable Dielectric Material Size Using with
16453A**

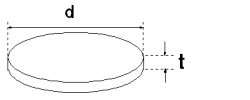
	t	≤ 3 mm
	d	≥ φ 15 mm

**Table 12-6.
Applicable Magnetic Material Size Using with 16454A**

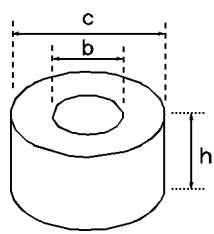
	Fixture	Small		Large	
	Holder	A	B	C	D
	c	≤ φ 8 mm	≤ φ 6 mm	≤ φ 20 mm	≤ φ 20 mm
	b	≥ φ 3.1 mm	≥ φ 3.1 mm	≥ φ 6 mm	≥ φ 5 mm
h	≤ 3 mm	≤ 3 mm	≤ 10 mm	≤ 10 mm	

Option 002 Material Measurement Accuracy with Option 013 and 014 High Temperature Test Head (Typical)

Dielectric Material Measurement Accuracy with High Temperature Test Head (Typical)

Conditions of Dielectric Material Measurement Accuracy with High Temperature Test Head
<ul style="list-style-type: none"> ■ Environment temperature is within $\pm 5^{\circ}\text{C}$ of temperature at which calibration is done, and within 0°C to 40°C. ■ High Temperature High Impedance Test Head must be used. ■ Bending cable should be smooth and the bending angle is less than 30°. ■ Cable position should be kept in the same position after calibration measurement. ■ OPEN/SHORT/$50\ \Omega$ calibration must be done. Calibration ON. ■ Measurement points are same as the calibration points. ■ Averaging (on point) factor must be larger than 32 at which calibration is done. ■ OSC level must be same as level at which calibration is done. ■ OSC level is less than or equal to $0.25\ V_{\text{rms}}$, or greater than $0.25\ V_{\text{rms}}$ and frequency range is within 1 MHz to 1 GHz. ■ Environment temperature of the main frame is within $\pm 5^{\circ}\text{C}$ of temperature at which calibration is done, and within 0°C to 40°C.

ϵ_r' Accuracy ($\frac{\Delta\epsilon_r'}{\epsilon_r'}$) Same as accuracy at which a normal test head is used

Loss Tangent Accuracy of ϵ_r ($\Delta\tan\delta$) Same as accuracy at which a normal test head is used

At the following frequency points, instrument spurious characteristics could occasionally cause measurement errors to exceed specified value because of instrument spurious characteristics.			
10.71 MHz	17.24 MHz	21.42 MHz	42.84 MHz
514.645 MHz	686.19333 MHz	1029.29 MHz	1327.38666 MHz

See "EMC" under "Others" in "General Characteristics".

The excessive vibration and shock could occasionally cause measurement errors to exceed specified value.

Material Measurement Accuracy with High Temperature Test Head

Typical Effects of Temperature Drift on Dielectric Material Measurement Accuracy

When environment temperature is without $\pm 5^\circ\text{C}$ of temperature at which calibration is done, add the following measurement error.

$$\epsilon_r' \text{ Accuracy } \left(\frac{\Delta\epsilon_{rm}'}{\epsilon_{rm}'} \right) \dots\dots\dots E_\epsilon + E_{a3} + E_{b3} \text{ [%]}$$

$$\text{Loss Tangent Accuracy of } \epsilon_r (\Delta\tan\delta) \dots\dots\dots E_{\tan\delta_\epsilon} + \frac{(E_{a3} + E_{b3})}{100}$$

Where,

E_ε is ϵ_r' accuracy when a normal test head is used.

E_{tanδ_ε} is loss tangent accuracy when a normal test head is used.

E_{a3} is the effect of temperature drift on the accuracy as follows:

$$E_{a3} = T_c \Delta T$$

E_{b3} is the hysteresis of the effect of temperature drift on the accuracy as follows:

$$E_{b3} = \frac{T_c \Delta T}{3}$$

where,

T_c is temperature coefficient as follows:

$$T_c = K_1 + K_2 + K_3$$

$$K_1 = 1 \times 10^{-6} \times (50 + 300f)$$

$$K_2 = 3 \times 10^{-6} \times (4 + 50f) \left(\frac{\epsilon_{rm}'}{t} \frac{1}{|1 - (f/f_0)^2|} + 10 \right) f$$

$$K_3 = 5 \times 10^{-3} \times (0.2 + 8f^2) \frac{1}{\left(\frac{\epsilon_{rm}'}{t} \frac{1}{|1 - (f/f_0)^2|} + 10 \right) f}$$

f : Measurement Frequency [GHz]

$$f_0 = \frac{13}{\sqrt{\epsilon_{rm}'}} \text{ [GHz]}$$

t : Thickness of MUT [mm]

ϵ_{rm}' : measured value of ϵ_r'

The illustrations of temperature coefficient T_c are shown in Figure 12-34 to Figure 12-36.

ΔT is difference of temperature between measurement condition and calibration measurement condition as follows:

Material Measurement Accuracy with High Temperature Test Head

$$\Delta T = |T_{\text{meas}} - T_{\text{cal}}|$$

T_{meas} : Temperature of Test Head at measurement condition

T_{cal} : Temperature of Test Head at calibration measurement condition

Material Measurement Accuracy with High Temperature Test Head

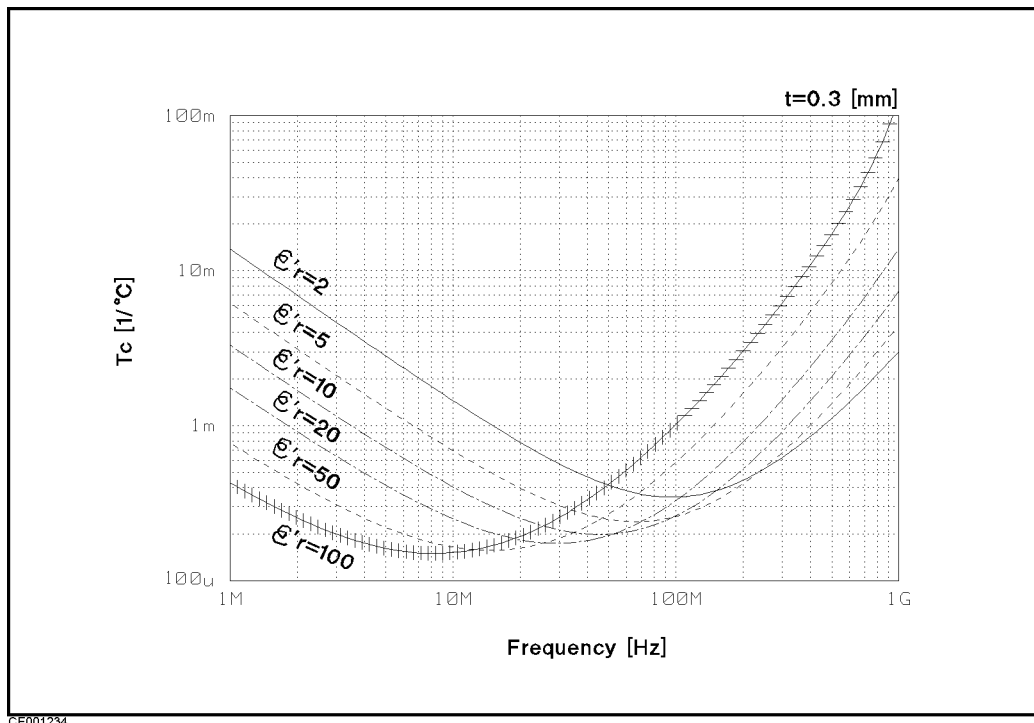

CE001234

Figure 12-34.
Typical Frequency Characteristics of Temperature Coefficient of ϵ_r ' and Loss Tangent Accuracy
(Thickness = 0.3 mm)

Material Measurement Accuracy with High Temperature Test Head

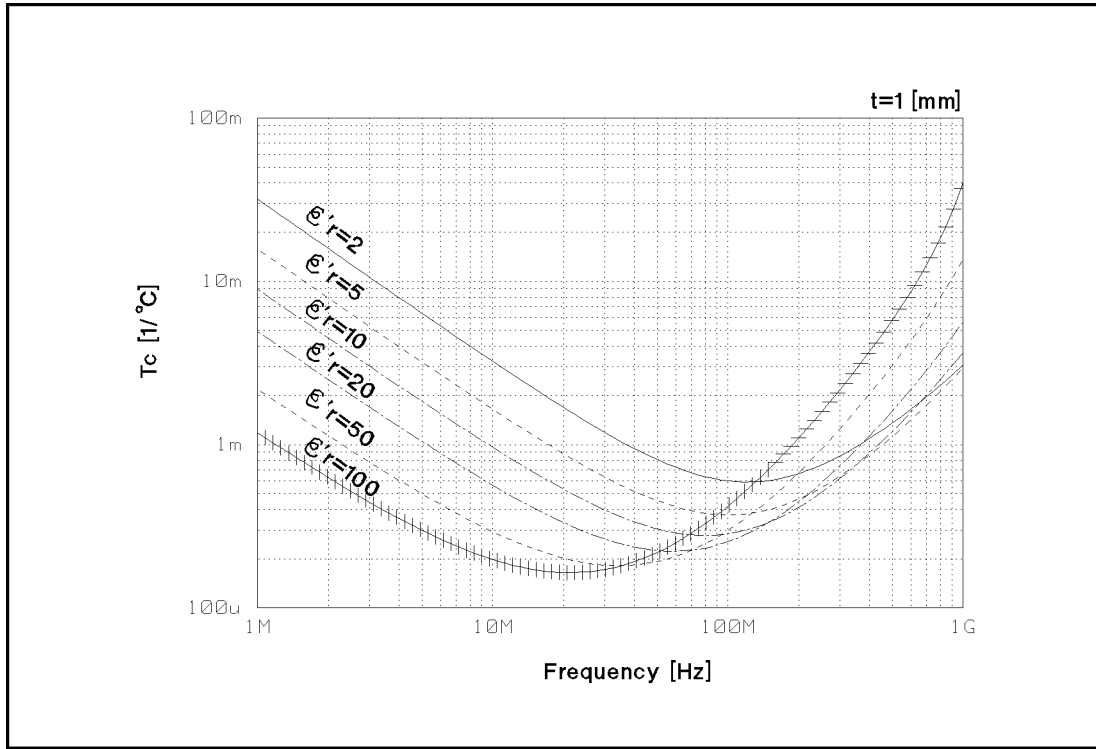

Figure 12-35.
Typical Frequency Characteristics of Temperature Coefficient of ϵ_r ' and Loss Tangent Accuracy
(Thickness = 1 mm)

Material Measurement Accuracy with High Temperature Test Head

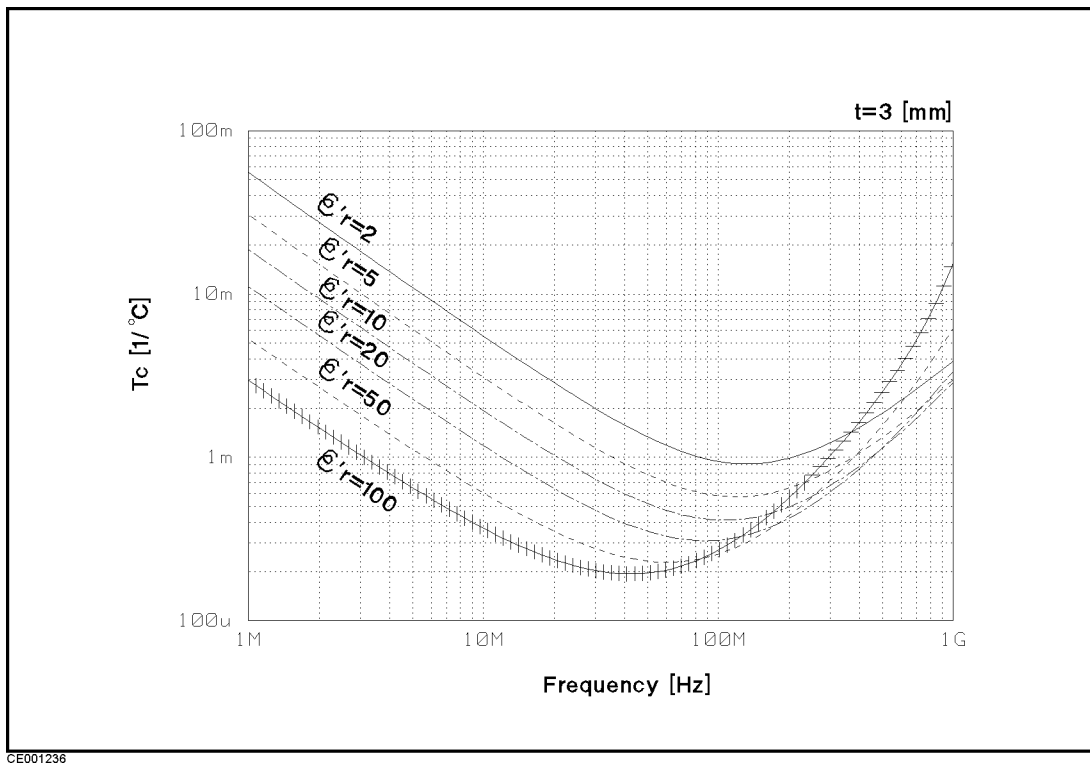

Figure 12-36.
Typical Frequency Characteristics of Temperature Coefficient of ϵ_r' and Loss Tangent Accuracy
(Thickness = 3 mm)

Material Measurement Accuracy with High Temperature Test Head

Magnetic Material Measurement Accuracy with High Temperature Test Head (Typical)

Conditions of Dielectric Material Measurement Accuracy with High Temperature Test Head
<ul style="list-style-type: none"> ■ Environment temperature is within $\pm 5^{\circ}\text{C}$ of temperature at which calibration is done, and within 0°C to 40°C. ■ High Temperature Low Impedance Test Head must be used. ■ Bending cable should be smooth and the bending angle is less than 30°. ■ Cable position should be kept in the same position after calibration measurement. ■ OPEN/SHORT/$50\ \Omega$ calibration must be done. Calibration ON. ■ Measurement points are same as the calibration points. ■ Averaging (on point) factor must be larger than 32 at which calibration is done. ■ OSC level must be same as level at which calibration is done. ■ OSC level is less than or equal to $0.25\ V_{\text{rms}}$, or greater than $0.25\ V_{\text{rms}}$ and frequency range is within 1 MHz to 1 GHz. ■ Environment temperature of the main frame is within $\pm 5^{\circ}\text{C}$ of temperature at which calibration is done, and within 0°C to 40°C.

μ_r' Accuracy ($\frac{\Delta\mu_{rm}'}{\mu_{rm}'}$) . Same as accuracy at which a normal test head is used

Loss Tangent Accuracy of μ_r ($\Delta\tan\delta$) Same as accuracy at which a normal test head is used

At the following frequency points, instrument spurious characteristics could occasionally cause measurement errors to exceed specified value because of instrument spurious characteristics.			
10.71 MHz	17.24 MHz	21.42 MHz	42.84 MHz
514.645 MHz	686.19333 MHz	1029.29 MHz	1327.38666 MHz

See "EMC" under "Others" in "General Characteristics".

The excessive vibration and shock could occasionally cause measurement errors to exceed specified value.

Material Measurement Accuracy with High Temperature Test Head

Typical Effects of Temperature Drift on Magnetic Material Measurement Accuracy

When environment temperature is without $\pm 5^\circ\text{C}$ of temperature at which calibration is done, add the following measurement error.

$$\mu_r' \text{ Accuracy } \left(\frac{\Delta \mu_{rm}'}{\mu_{rm}'} \right) \dots\dots\dots E_\mu + E_{a3} + E_{b3}$$

$$\text{Loss Tangent Accuracy of } \dot{\mu}_r (\Delta \tan \delta) \dots\dots\dots E_{\tan \delta \mu} + \frac{(E_{a3} + E_{b3})}{100}$$

Where,

E_μ is μ_r' accuracy at which a normal test head is used.

E_{tanδμ} is loss tangent accuracy at which a normal test head is used.

E_{a3} is the effect of temperature drift on the accuracy as follows:

$$E_{a3} = T_c \Delta T$$

E_{b3} is the hysteresis of the effect of temperature drift on the accuracy as follows:

$$E_{b3} = \frac{T_c \Delta T}{3}$$

where,

T_c is temperature coefficient as follows:

$$T_c = K_1 + K_2 + K_3$$

$$K_1 = 1 \times 10^{-6} \times (50 + 300f)$$

$$K_2 = 1 \times 10^{-2} \times (1 + 10f^2) \frac{|1 - 0.01\{F(\mu_{rm}' - 1) + 10\}f^2|}{\{F(\mu_{rm}' - 1) + 20\}f}$$

$$K_3 = 2 \times 10^{-6} \times (1 + 30f) \frac{\{F(\mu_{rm}' - 1) + 20\}f}{|1 - 0.01\{F(\mu_{rm}' - 1) + 10\}f^2|}$$

f : Measurement Frequency [GHz]

$$F = h \ln \frac{c}{b} \text{ [mm]}$$

h is the height of MUT [mm]

b is the inner diameter of MUT

c is the outer diameter of MUT

μ_{rm}' is the measured value of permeability

The illustrations of temperature coefficient **T_c** are shown in Figure 12-37 to Figure 12-39.

Material Measurement Accuracy with High Temperature Test Head

ΔT is difference of temperature between measurement condition and calibration measurement condition as follows:

$$\Delta T = |T_{\text{meas}} - T_{\text{cal}}|$$

T_{meas} : Temperature of Test Head at measurement condition

T_{cal} : Temperature of Test Head at calibration measurement condition

Material Measurement Accuracy with High Temperature Test Head

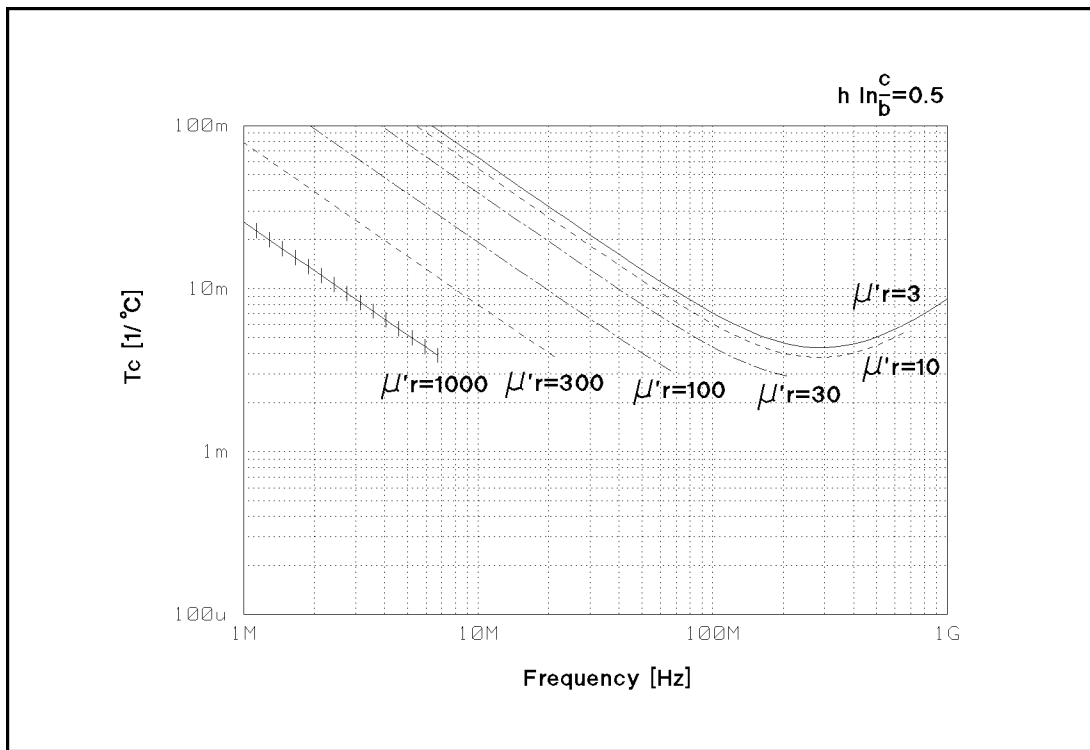

CE001237

Figure 12-37.

Typical Frequency Characteristics of Temperature Coefficient of μ'_r and Loss Tangent Accuracy ($F^* = 0.5$)

Material Measurement Accuracy with High Temperature Test Head

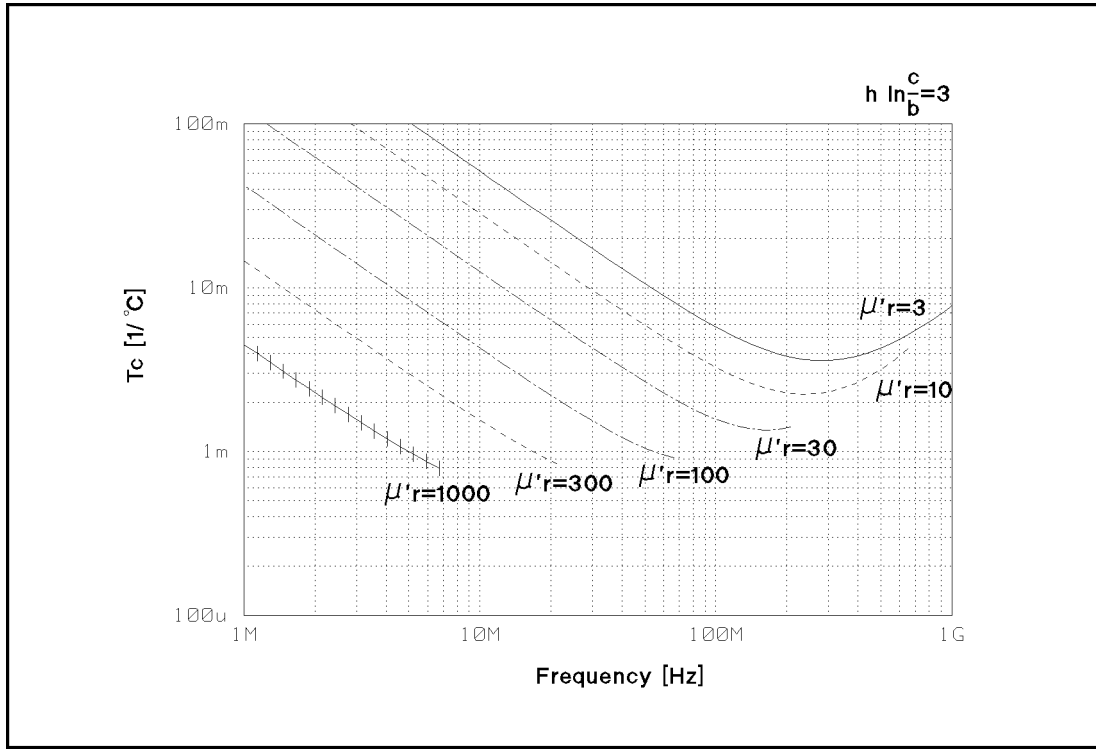

CE001238

Figure 12-38.

Typical Frequency Characteristics of Temperature Coefficient of μ'_r and Loss Tangent Accuracy
($F^* = 3$)

* $F^* = h \ln \frac{c}{b}$

Material Measurement Accuracy with High Temperature Test Head

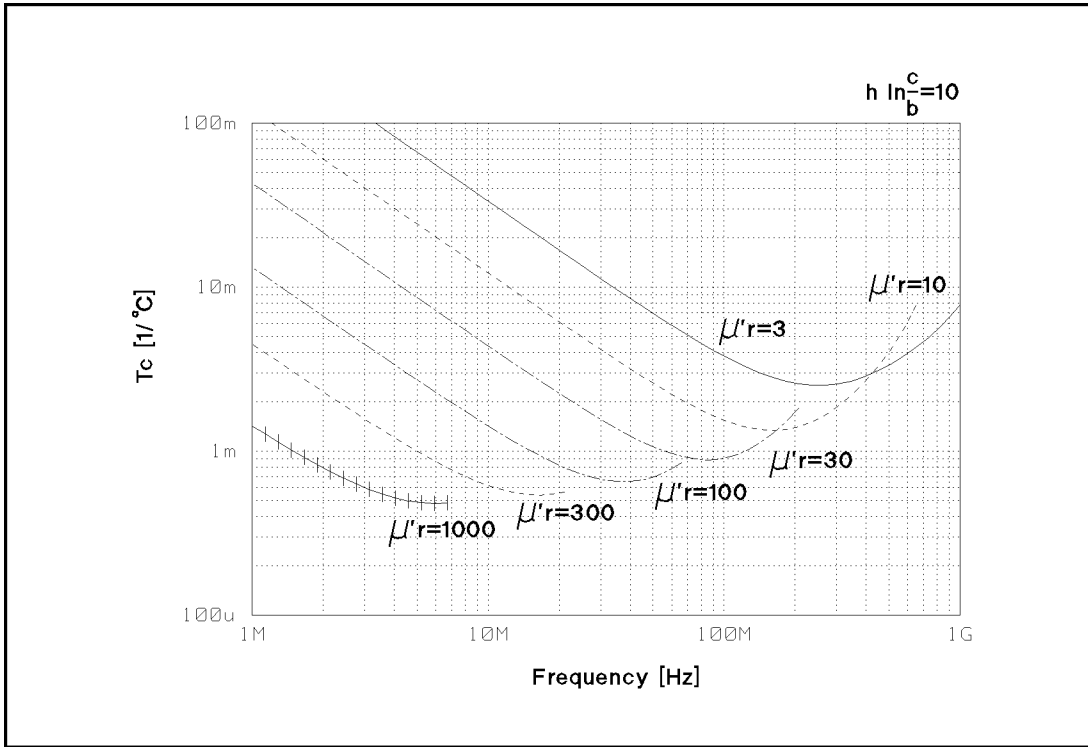

CE001239

Figure 12-39.

Typical Frequency Characteristics of Temperature Coefficient of μ'_r and Loss Tangent Accuracy ($F^* = 10$)

* $F = h \ln \frac{c}{b}$

Furnished Accessories

Accessory	Agilent part number
Operating Manual	04291-90020
Quick Start Guide	04291-90021
Programming Manual	04291-90027
Service Manual ¹	04291-90111
Program Disk Set	04291-18000
Power Cable ²	
50 Ω Termination	04291-65006
0 Ω Termination	04191-85300
0 S Termination	04191-85302
Low-Loss Capacitor	04291-60042
Calibration Kit Carrying Case	04291-60041
APC-7 End Cap	16190-25011
Fixture Stand ³	04291-60121
Pad ³	04291-09001
Temperature Coefficient Measurement Program Disk ³	04291-18001
BNC Adapter ⁴	1250-1859
mini-DIN Keyboard	C3757-60401
HP Instrument BASIC Users Handbook	E2083-90005
Handle Kit ⁵	5062-3991
Rack Mount Kit ⁶	5062-3979
Rack Mount and Handle Kit ⁷	5062-3985

1 Option 0BW only

2 The power cable depends on where the instrument is used, see Quick Start Guide

3 Option 013 and 014 only

4 Option 1D5 only

5 Option 1CN only

6 Option 1CM only

7 Option 1CP only

Manual Changes

Introduction

This appendix contains the information required to adapt this manual to earlier versions or configurations of the analyzer than the current printing date of this manual. The information in this manual applies directly to the 4291B RF Impedance/Material Analyzer serial number prefix listed on the title page of this manual.

Manual Changes

To adapt this manual to your 4291B, see Table A-1 and Table A-2, and make all the manual changes listed opposite your instrument's serial number and firmware version.

Instruments manufactured after the printing of this manual may be different from those documented in this manual. Later instrument versions will be documented in a manual changes supplement that will accompany the manual shipped with that instrument. If your instrument's serial number is not listed on the title page of this manual or in Table A-1, it may be documented in a *yellow MANUAL CHANGES* supplement.

In additions to change information, the supplement may contain information for correcting errors (Errata) in the manual. To keep this manual as current and accurate as possible, Agilent Technologies recommends that you periodically request the latest *MANUAL CHANGES* supplement.

For information concerning serial number prefixes not listed on the title page or in the *MANUAL CHANGE* supplement, contact the nearest Agilent Technologies office.

Turn on the line switch or execute the *IDN? command by GPIB to confirm the firmware version. See the *Programming Manual* manual for information on the *IDN? command.

Table A-1. Manual Changes by Serial Number

Serial Prefix or Number	Make Manual Changes

Table A-2. Manual Changes by Firmware Version

Version	Make Manual Changes

Serial Number

Agilent Technologies uses a two-part, ten-character serial number that is stamped on the serial number plate (see Figure A-1) attached to the rear panel. The first five characters are the serial prefix and the last five digits are the suffix.

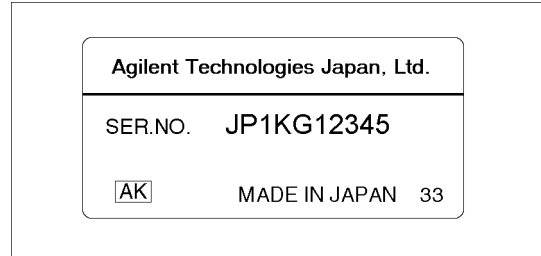

Figure A-1. Serial Number Plate

Input Range and Default Setting

When the **(Preset)** key is pressed or the analyzer is turned ON, the analyzer is set to a known state. There are subtle differences between the preset state and the power-up state.

Some power-up states are recalled from non-volatile memory (battery backup memory). If power to the non-volatile memory is lost, the analyzer will have certain parameters set to factory settings. Factory Setting lists the factory settings. The operating time of the battery backup memory is approximately 72 hours. The battery is automatically recharged while the instrument is ON. The recharge time (time required to fully recharge the battery) is approximately 10 minutes.

When line power is cycled the analyzer performs a self-test routine. Upon successful completion of the self-test routine, the instrument state is set to the following preset conditions. The same conditions are true following a “PRES” or “*RST” command via GPIB.

Function	Range	Preset Value	Power ON default	Factory Setting
Measurement Mode	Active channel, Dual channel	Active channel	Active channel	
Measurement Parameter				
Ch1:Impedance meas.	$ Z , \theta_z, R, X, Y , \theta_y, G, B, \Gamma , \theta_\gamma, \Gamma_x, \Gamma_y, C_p, C_s, L_p, L_s, R_p, R_s, D, Q$	$ Z $	$ Z $	
Ch2:Impedance meas.	$ Z , \theta_z, R, X, Y , \theta_y, G, B, \Gamma , \theta_\gamma, \Gamma_x, \Gamma_y, C_p, C_s, L_p, L_s, R_p, R_s, D, Q$	θ_z	θ_z	
Ch1: ε meas.	$ \varepsilon , \tan \delta, \varepsilon', \varepsilon'', Z , \theta_z, R, X, Y , \theta_y, G, B, \Gamma , \theta_\gamma, \Gamma_x, \Gamma_y, C_p, C_s, L_p, L_s, R_p, R_s, D, Q$	ε'	ε'	
Ch2: ε meas.	$ \varepsilon , \tan \delta, \varepsilon', \varepsilon'', Z , \theta_z, R, X, Y , \theta_y, G, B, \Gamma , \theta_\gamma, \Gamma_x, \Gamma_y, C_p, C_s, L_p, L_s, R_p, R_s, D, Q$	ε''	ε''	
Ch1: μ meas.	$ \mu , \tan \delta, \mu', \mu'', Z , \theta_z, R, X, Y , \theta_y, G, B, \Gamma , \theta_\gamma, \Gamma_x, \Gamma_y, C_p, C_s, L_p, L_s, R_p, R_s, D, Q$	μ'^1	μ'^1	
Ch2: μ meas.	$ \mu , \tan \delta, \mu', \mu'', Z , \theta_z, R, X, Y , \theta_y, G, B, \Gamma , \theta_\gamma, \Gamma_x, \Gamma_y, C_p, C_s, L_p, L_s, R_p, R_s, D, Q$	μ''^1	μ''^1	
Test Fixture	16191A, 16192A, 16193A, User, None, 16193A, 16194A	None or No effect (when either the 16193A or 16194A is selected)	None	
User Fixture Definition				
Label		No effect	No effect	(empty)
Extension	- 10 meter to 10 meter	No effect	No effect	0
Thickness	0 to 3 mm	No effect	UNDEFINED	
Outer diameter		No effect	UNDEFINED	
Inner diameter		No effect	UNDEFINED	

1 After setting material size

Function	Range	Preset Value	Power ON default	Factory Setting
Format	Linear, Log, Polar, Smith, Admittance, Complex	Linear	Linear	
Expanded Phase	ON/OFF	OFF	OFF	
Phase Unit	Degree, Radian	Degree	Degree	
X-axis Lin/Log	Linear, Logarithm	Linear	Linear	
Y-axis Lin/Log	Linear, Logarithm	Linear	Linear	

Display

Function	Range	Preset Value	Power ON default	Factory Setting
Dual Chan	ON/OFF	ON	ON	
Split Display	ON/OFF	OFF	OFF	
Define Trace	Data, Memory, Data and Memory	Data	Data	
Select memory trace	1 to 16 (Total NOP of memory traces \leq 801 \times 3)	1	1	
Data math	Data, Data-Mem, Data + Mem, Data/Mem	Data	Data	
Gain	-1×10^6 to 1×10^6	1	1	
Offset	-100×10^6 to 100×10^6	0	0	
AUX offset	-100×10^6 to 100×10^6	0	0	
Equivalent Circuit	Circuit A, B, C, D, E, F	A	A	
Equivalent Parameter R_1	-1×10^{18} to 1×10^{18}	0	0	
Equivalent Parameter L_1	-1×10^{18} to 1×10^{18}	0	0	
Equivalent Parameter C_0	-1×10^{18} to 1×10^{18}	0	0	
Equivalent Parameter C_1	-1×10^{18} to 1×10^{18}	0	0	
Disp EQV param	ON/OFF	OFF	OFF	
Title		null string	null string	
Text	Max 20 Labels	null string	null string	
X position	0 to 609	+ 10		
Y position	0 to 421	+ 30		
Graphic/Memory trace Selection	Graphic, Memory trace	No effect	No effect	Graphics
Frequency Blank	ON	OFF	OFF	
Display Allocation	All instrument, Half/Half, All BASIC, BASIC status	All Instrument	All Instrument	
Intensity	0 to 100 %	No effect	83 %	
Background Intensity	0 to 100 %	No effect	0	
Backlight	ON/OFF	ON	ON	ON
User trace	ON/OFF	OFF	OFF	
User trace headline	Maximum 12 characters	USER TRACE (1-4)	USER TRACE (1-4)	
User trace footnote	Maximum 34 characters	(null string)	(null string)	

Scale Ref

Scale Ref

Function	Range	Preset Value	Power ON default	Factory Setting
Scale Coupling	Coupling, Uncoupling	Coupling	Coupling	
Reference Position	0 to 10	5	5	
Scale top value (linear scale)				
Z , R, R _p , R _s , X	-1×10 ⁹ to 1×10 ⁹	1 MΩ	1 MΩ	
Y , G, B	-1×10 ⁹ to 1×10 ⁹	1 S	1 S	
Γ , Γ _x	-1×10 ⁹ to 1×10 ⁹	1	1	
Γ _y	-1×10 ⁹ to 1×10 ⁹	1	1	
C _p , C _s	-1×10 ⁹ to 1×10 ⁹	1 mF	1 mF	
L _p , L _s	-1×10 ⁹ to 1×10 ⁹	10 H	10 H	
θ	-1×10 ⁹ to 1×10 ⁹	180°	180°	
D	-1×10 ⁹ to 1×10 ⁹	1	1	
Q	-1×10 ⁹ to 1×10 ⁹	1 k	1 k	
Scale bottom value (linear scale)				
Z , R, R _p , R _s , X	-500×10 ⁶ to 500×10 ⁶	0 Ω	0 Ω	
Y , G, B	-500×10 ⁶ to 500×10 ⁶	0 S	0 S	
Γ , Γ _x , Γ _y	-500×10 ⁶ to 500×10 ⁶	-1	-1	
C _p , C _s	-500×10 ⁶ to 500×10 ⁶	0 F	0 F	
L _p , L _s	-500×10 ⁶ to 500×10 ⁶	0 H	0 H	
θ	-500×10 ⁶ to 500×10 ⁶	-180°	-180°	
D	-500×10 ⁶ to 500×10 ⁶	0	0	
Q	-500×10 ⁶ to 500×10 ⁶	0	0	
Scale/Div				
Z , R, R _p , R _s , X	1×10 ⁻¹⁵ to 100×10 ⁶	100 kΩ	100 kΩ	
Y , G, B	1×10 ⁻¹⁵ to 100×10 ⁶	100 ms	100 ms	
Γ , Γ _x , Γ _y	1×10 ⁻¹⁵ to 100×10 ⁶	0.2	0.2	
C _p , C _s	1×10 ⁻¹⁵ to 100×10 ⁶	100 μF	100 μF	
L _p , L _s	1×10 ⁻¹⁵ to 100×10 ⁶	1 H	1 H	
θ	1×10 ⁻¹⁵ to 100×10 ⁶	36°	36°	
D	1×10 ⁻¹⁵ to 100×10 ⁶	0.1	0.1	
Q	1×10 ⁻¹⁵ to 100×10 ⁶	100	100	

Function	Range	Preset Value	Power ON default	Factory Setting
Reference value				
Z , R, R _p , R _s , X	-500×10 ⁶ to 500×10 ⁶	500 kΩ	500 kΩ	
Y , G, B	-500×10 ⁶ to 500×10 ⁶	500 ms	500 ms	
Γ , Γ _x , Γ _y	-500×10 ⁶ to 500×10 ⁶	0	0	
C _p , C _s	-500×10 ⁶ to 500×10 ⁶	500 μF	500 μF	
L _p , L _s	-500×10 ⁶ to 500×10 ⁶	5 H	5 H	
θ	-500×10 ⁶ to 500×10 ⁶	0°	0°	
D	-500×10 ⁶ to 500×10 ⁶	0.5	0.5	
Q	-500×10 ⁶ to 500×10 ⁶	500	500	
Scale top value (logarithm scale)				
Z , R, R _p , R _s , X	-1×10 ⁹ to 1×10 ⁹	1 MΩ	1 MΩ	
Y , G, B	-1×10 ⁹ to 1×10 ⁹	1 S	1 S	
Γ , Γ _x , Γ _y	-1×10 ⁹ to 1×10 ⁹	1	1	
C _p , C _s	-1×10 ⁹ to 1×10 ⁹	1 mF	1 mF	
L _p , L _s	-1×10 ⁹ to 1×10 ⁹	10 H	10 H	
θ	-1×10 ⁹ to 1×10 ⁹	200°	200°	
D	-1×10 ⁹ to 1×10 ⁹	1	1	
Q	-1×10 ⁹ to 1×10 ⁹	1 k	1 k	
Scale bottom value (logarithm scale)				
Z , R, R _p , R _s , X	-500×10 ⁶ to 500×10 ⁶	1 Ω	1 Ω	
Y , G, B	-500×10 ⁶ to 500×10 ⁶	1 μs	1 μs	
Γ , Γ _x , Γ _y	-500×10 ⁶ to 500×10 ⁶	1×10 ⁶	1×10 ⁶	
C _p , C _s	-500×10 ⁶ to 500×10 ⁶	1 nF	1 nF	
L _p , L _s	-500×10 ⁶ to 500×10 ⁶	10 pH	10 pH	
θ	-500×10 ⁶ to 500×10 ⁶	10 μ°	10 μ°	
D	-500×10 ⁶ to 500×10 ⁶	1 μ	1 μ	
Q	-500×10 ⁶ to 500×10 ⁶	1	1	
Reference X Value	-500×10 ⁶ to 500×10 ⁶	0	0	
Reference Y Value	-500×10 ⁶ to 500×10 ⁶	0	0	
Scale for	Data, Memory 1 to 16	Data	Data	
Data & Memory Scale	Couple/Uncouple	Couple	Couple	
X-axis unit	Maximum 4 characters	U	U	
Y-axis unit	Maximum 4 characters	U	U	
X-axis left value	-8×10 ⁹ to 8×10 ⁹	1×10 ⁶	1×10 ⁶	
X-axis right value	-8×10 ⁹ to 8×10 ⁹	1.8×10 ⁹	1.8×10 ⁹	
Y-axis top value	-1×10 ¹² to 1×10 ¹²	100	100	
Y-axis bottom value	-1×10 ¹² to 1×10 ¹²	0	0	
X/Y-axis couple	ON,OFF	ON	ON	

Bw/Avg Cal

Bw/Avg

Function	Range	Preset Value	Power ON default	Factory Setting
Sweep Averaging	ON/OFF	OFF	OFF	
Sweep Averaging Factor	1 to 999	16	16	
Point Averaging	ON/OFF	OFF	OFF	
Point Averaging Factor	1 to 999	1	1	

Cal

Function	Range	Preset Value	Power ON default	Factory Setting
Fixture Compen - OPEN	ON/OFF	OFF	OFF	
Fixture Compen - SHORT	ON/OFF	OFF	OFF	
Fixture Compen - LOAD	ON/OFF	OFF	OFF	
Cal Kit	7 mm, User kit	7 mm	7 mm	
Standard Value - OPEN G	-1×10^6 to 1×10^6	0	0	
Standard Value - OPEN C	-1×10^{-9} to 1×10^{-9}	82 fF	82 fF	
Standard Value - SHORT R	-1×10^6 to 1×10^6	0	0	
Standard Value - SHORT L	-1×10^6 to 1×10^6	0	0	
Standard Value - LOAD R	-1×10^6 to 1×10^6	50 Ω	50 Ω	
Standard Value - LOAD X	-1×10^6 to 1×10^6	0	0	
Compen Kit				
Compen Std. Value - OPEN G	-1×10^6 to 1×10^6	No effect ¹	No effect ¹	0
Compen Std Value - OPEN C	-1×10^{-9} to 1×10^{-9}	No effect ¹	No effect ¹	0
Compen Std. Value - SHORT R	-1×10^6 to 1×10^6	No effect ¹	No effect ¹	0
Compen Std. Value - SHORT L	-1×10^6 to 1×10^6	No effect ¹	No effect ¹	0
Compen Std. Value - LOAD R	-1×10^6 to 1×10^6	No effect ¹	No effect ¹	50 Ω
Compen Std Value - LOAD X	-1×10^6 to 1×10^6	No effect ¹	No effect ¹	0
Compen standard Label		No effect ¹	No effect ¹	user
Port extension	ON/OFF	OFF	OFF	
Port Extension value	-10 to 10	0 s	0 s	

1 When SAVE COMPEN KIT is executed.

Cal (ϵ)

Function	Range	Preset Value	Power ON default	Factory Setting
Material size - Thickness	1 μ m to 4.8 mm	invalid	invalid	
LOAD ϵ_r'	-1×10^6 to 1×10^6	not effect	not effect	2.1
LOAD ϵ_r''	-1×10^6 to 1×10^6	not effect	not effect	0
LOAD Thickness	0 to 1×10^6 m	not effect	not effect	800×10^{-6} m

Cal (μ)

Function	Range	Preset Value	Power ON default	Factory Setting
Material size for 16454A small				
Inner diameter	3.04 mm to 9 mm	invalid	invalid	
Outer Diameter	3.04 mm to 9 mm	invalid	invalid	
Height	0.01 mm to 3.65 mm	invalid	invalid	
Material size for 16454A large				
Inner diameter	3 mm to 21 mm	invalid	invalid	
Outer Diameter	3 mm to 21 mm	invalid	invalid	
Height	0.01 mm to 11.6 mm	invalid	invalid	

Sweep Source Trigger

Sweep

Function	Range	Preset Value	Power ON default	Factory Setting
Delay time	0 to 3600 s	0 ms	0 ms	
Trigger delay time	0 to 3600 s	0 ms	0 ms	
Number of points	2 to 801	201	201	
Coupled channel	ON/OFF	ON	ON	
Sweep source	Freq., OSC level, DC-V, DC-I	Frequency	Frequency	
Sweep type	Linear, Log, List	Linear	Linear	
List table		(empty)	(empty)	
List segment	0 to 15	0	0	
Sweep direction	UP/DOWN	UP	UP	

Source

Function	Range	Preset Value	Power ON default	Factory Setting
Osc level	0.2 mV to 1 V	0.5 V	0.5 V	
Osc level unit	Voltage, dBm, Ampere	Volt	Volt	
CW Frequency	1 MHz to 1.8 GHz	500 MHz	500 MHz	
DC BIAS	ON/OFF	OFF	OFF	
Voltage	-40 V to +40 V	0 V	0 V	
Current	-100 mA to 100 mA	0 A	0 A	
Voltage limit	1 V to 40 V	1 V	1 V	
Current limit	2 mA to 100 mA	2 mA	2 mA	
DC BIAS source	I-constant/V-constant	V-constant	V-constant	

Trigger

Function	Range	Preset Value	Power ON default	Factory Setting
Sweep	Hold, Single, Number of group, Continuous	Continuous	Continuous	
Number of Groups	1 to 999	-	-	
Trigger	Free run, External, GPIB, Manual	Free run	Free run	
Trigger event	ON SWEEP/ON POINT	On Sweep	On Sweep	
Trigger polarity	Positive, Negative	Positive	Positive	

Start, Stop, Center, Span

Function	Range	Preset Value	Power ON default	Factory Setting
Start				
Frequency	1 MHz to 1.8 GHz	1 MHz	1 MHz	
Osc level	200 μ V to 1 V	200 μ V	200 μ V	
DC-V	-40 V to 40 V	0 V	0 V	
DC-I	-100 mA to 100 mA	0 A	0 A	
Stop				
Frequency	1 MHz to 1.8 GHz	1.8 GHz	1.8 GHz	
Osc level	200 μ V to 1 V	1 V	1 V	
DC-V	-40 V to 40 V	0 V	0 V	
DC-I	-100 mA to 100 mA	0 A	0 A	
Center				
Frequency	1 MHz to 1.8 GHz	900.5 MHz	900.5 MHz	
Osc level	200 μ V to 1 V	500.1 mV	500.1 mV	
DC-V	-40 V to 40 V	0 V	0 V	
DC-I	-100 mA to 100 mA	0 A	0 A	
Span				
Frequency	0 to 1.799 GHz	1.799 GHz	1.799 GHz	
Osc level	0 to 999.8 mV	999.8 mV	999.8 mV	
DC-V	0 to 80 V	0 V	0 V	
DC-I	0 to 200 mA	0 A	0 A	

Marker

Function	Range	Preset Value	Power ON default	Factory Setting
Trace using markers	Data, Memory 1 to 16, User trace 1 to 4	Data	Data	
Marker coupling	Coupling/Uncoupling	Coupling	Coupling	
Marker cont/discont	Continuous/Discontinuous	Continuous	Continuous	
Δ marker mode	ON/OFF	OFF	OFF	
Fixed Δ marker stimulus value	START to STOP	0	0	
Fixed Δ marker value	-1 \times 10 ⁹ to 1 \times 10 ⁹	0	0	
Fixed Δ marker AUX value	-1 \times 10 ⁹ to 1 \times 10 ⁹	0	0	

Marker → Search Utility

Marker →

Function	Range	Preset Value	Power ON default	Factory Setting
Zooming aperture	0 to 100 %	10 % of span	10 % of span	
Cross channel	ON/OFF	OFF	OFF	

Search

Function	Range	Preset Value	Power ON default	Factory Setting
Width	ON/OFF	OFF	OFF	
Width value	Fixed, MKRVAL/ $(\sqrt{2})$, MKRVAL* $(\sqrt{2})$, MKRVAL/2	Fixed	Fixed	
Fixed width value	-100×10^6 to 100×10^6	-3	-3	
Threshold	ON/OFF	OFF	OFF	
Threshold value	-100×10^6 to 100×10^6	-100	-100	
Peak polarity	Positive, Negative	Positive	Positive	
Peak definition Δx				
Frequency	0 to 8×10^9	10 MHz	10 MHz	
OSC level	0 to 8	8	8	
DC-V	0 to 80	80	80	
DC-I	0 to 0.8	0.8	0.8	
Peak definition Δy	0 to 100×10^6	1	1	
Search tracking	ON/OFF	OFF	OFF	
Partial search	ON/OFF	OFF	OFF	
Target value	-100×10^7 to 100×10^7	-3	-3	

Utility

Function	Range	Preset Value	Power ON default	Factory Setting
Marker list	ON/OFF	OFF	OFF	
Statistics	ON/OFF	OFF	OFF	
Marker sweep parameter unit	Stimulus, Time, $1/2\pi f$	Stimulus	Stimulus	
Smith/polar marker	Real-imaginary, Lin magnitude-phase, Log magnitude-phase, R+jX, G+jB	Real-imaginary	Real-imaginary	

System

Function	Range	Preset Value	Power ON default	Factory Setting
Logging	ON/OFF	No effect	No effect	
Memory partition	64kRAM-448kBASIC, 128kRAM-334kBASIC, 256kRAM-256kBASIC, 334kRAM-128kBASIC, 448kRAM-64kBASIC	No effect	No effect	128kRAM- 334kBASIC
Clock time	0:00:00 to 23:59:59	No effect	No effect	0:00:00
Clock date	3/1/1900 to 12/31/2099	No effect	No effect	
Date mode	MonDayYear/DayMonYear	MonDayYear	MonDayYear	
Beep done	ON/OFF	ON	ON	
Beep warning	ON/OFF	OFF	OFF	
Limit line	ON/OFF	OFF	OFF	
Limit test	ON/OFF	OFF	OFF	
Limit beep	OFF, Path, Fail	OFF	OFF	
Limit segment	1 to 18			
Upper limit	-1×10^9 to 1×10^9	0	0	
Lower limit	-1×10^9 to 1×10^9	0	0	
Delta limit	-1×10^9 to 1×10^9	0	0	
Middle value	-1×10^9 to 1×10^9	0	0	
Stimulus offset				
Frequency	-1.8 GHz to 1.8 GHz	0	0	
OSC level	-1 to 1 V	0	0	
DC-V	-40 to 40 V	0	0	
DC-I	-100×10^{-3} to 100×10^{-3} A	0	0	
Limit line amplitude offset	-1×10^9 to 1×10^9	0	0	

Local

Function	Range	Preset Value	Power ON default	Factory Setting
GPIB controller mode	System controller/addressable	No effect	No effect	addressable
Address: 4291	0 to 30	No effect	No effect	17
Address: controller	0 to 30	No effect	No effect	21

Copy

Function	Range	Preset Value	Power ON default	Factory Setting
Print mode	Standard/Color	Standard	Standard	
Copy time	ON/OFF	OFF	OFF	
Print color	Fixed/Variable	Fixed	Fixed	
Print softkey	ON/OFF	OFF	OFF	OFF
Print resolution	75 to 600	75	75	75
Print margin (Left)	0 to 5	1.0	1.0	1.0
Print margin (Top)	0 to 5	1.0	1.0	1.0
Formfeed	ON/OFF	ON	ON	ON
Orientation	Portrait,Landscape	Portrait	Portrait	Portrait
Limit table display mode	Upper&Lower/Middle&Delt	Upper&Lower	Upper&Lower	
List table display mode	Start&Stop/Center&Span	Start&Stop	Start&Stop	

Save

Function	Range	Preset Value	Power ON default	Factory Setting
Save data definition	Raw, Cal, Data, Memory, Data trace, Memory trace	Data trace, Memory trace	Data trace, Memory trace	
Store device	Disk/Memory	No effect	No effect	Disk
Initialize disk format	LIF/DOS	No effect	No effect	LIF

Option 013, 014 Temperature Coefficient Measurement



Introduction

Agilent Technologies provides a high temperature test head and a high temperature fixture to achieve an efficient and highly reliable method for evaluating temperature characteristics.

The other features are as follows:

- *High Temperature Test Head* that can be used within the range of $-55\text{ }^{\circ}\text{C}$ to $200\text{ }^{\circ}\text{C}$, maintaining high accuracy.
- *High Temperature Test Fixture* that simplify DUT connection.

Espec Temperature Chamber SU-241 is designed to integrated easily with 4291B.

- *GPIB* as standard
- *Measuring Port* eliminating the needs to create additional measurement cables access hole.

Warning



The high temperature test head, 16194A, 16453A, and 16454A has the capability for $-55\text{ }^{\circ}\text{C}$ to $200\text{ }^{\circ}\text{C}$ temperature measurement in environmental testing. Use globes to prevent scalding when handling heated parts.

Setup and Installation Guide

This section provides the information necessary to set up your analyzer and temperature chamber.

Required Equipment

To perform all the steps in this quick start, the following equipment is required:

- 4291B RF Impedance/Material Analyzer
- mini-DIN Keyboard
- Test Head
 - High Temperature High-impedance Test Head (option 013), or
 - High Temperature Low-impedance Test Head (option 014)
- Fixture Stand (Agilent PN 04291-60121, included with option 013 or 014)
- Pad (Agilent PN 04291-09001, included with option 013 or 014)
- Calibration Kit (included with 4291B)
- Test Fixture
 - 16194A High Temperature SMD Fixture, or
 - 16453A Dielectric Material Test Fixture, or
 - 16454A Magnetic Material Test Fixture
- Chamber (Espec Chamber SU-241)
- Blank Diskette (2HD is recommended, Agilent PN 9164-0299)

Equipment Setup

Figure C-1 shows the equipment setup.

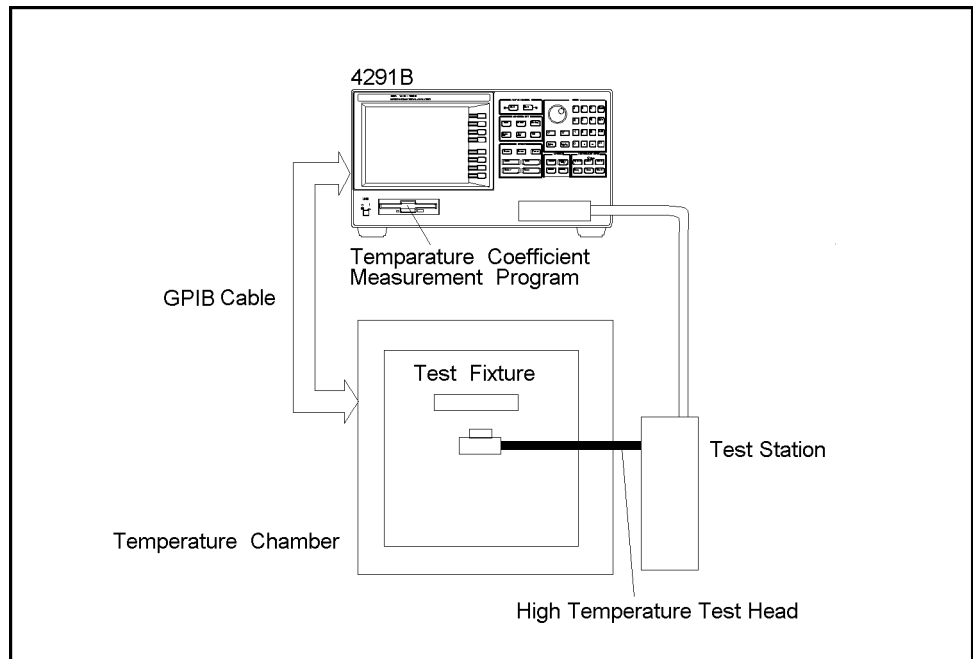
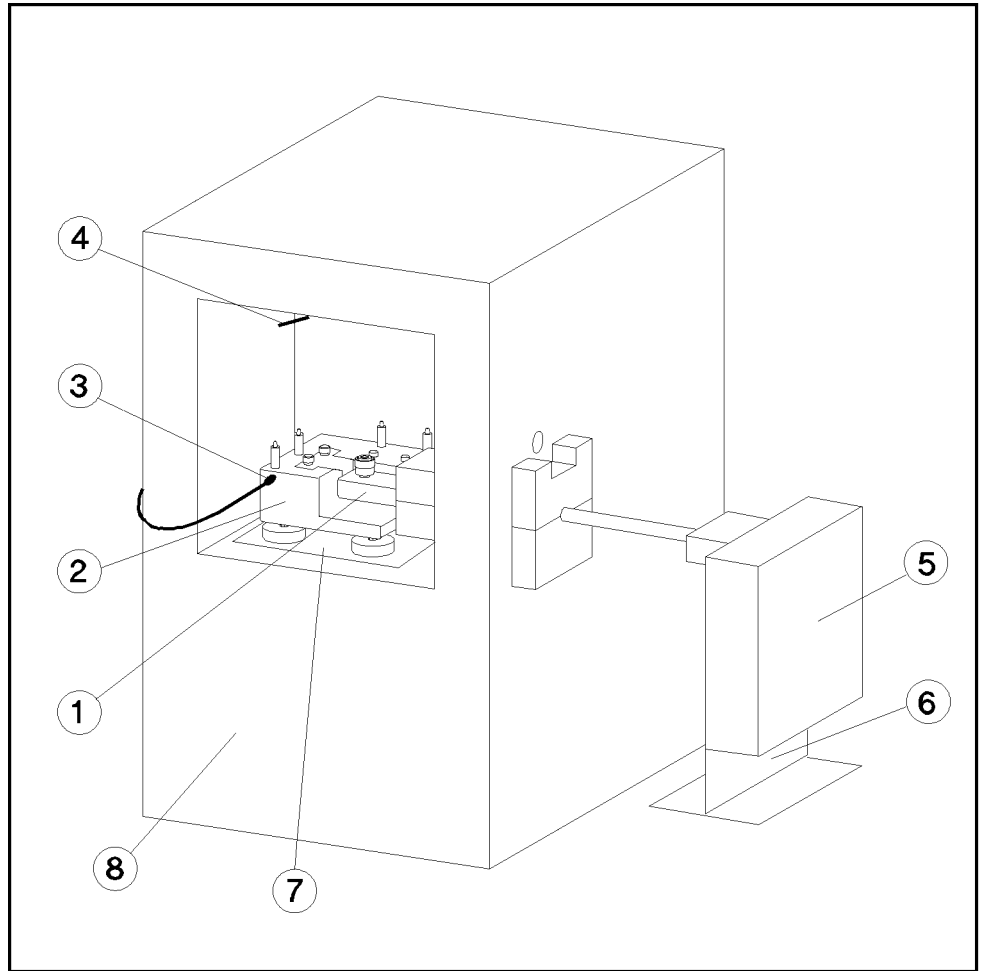

Figure C-1. Equipment Setup

Temperature Coefficient Measurement

Figure C-2 shows the test head and test stand setup.



C6201011

Figure C-2. Test Head and Test Stand Setup

- ① High Temperature Test Head
- ② Fixture Stand
- ③ Specimen Temperature Sensor
- ④ Chamber Temperature Sensor
- ⑤ Test Station
- ⑥ Test Station Stand
- ⑦ Pad
- ⑧ Temperature Chamber

Quick Start

Calibration

When the temperature/humidity becomes the reference values, perform calibration at the high temperature test head APC-7[®] connector. This calibration procedure is the same as the one for the impedance/dielectric/magnetic measurements. The USER DEFINED calibration is required when the high temperature test head is connected. The analyzer is set to the USER DEFINED calibration automatically.

Setting the Test Fixture

The test fixture should be set on the test head after calibration. The setup for the 16194A is shown in Figure C-3.

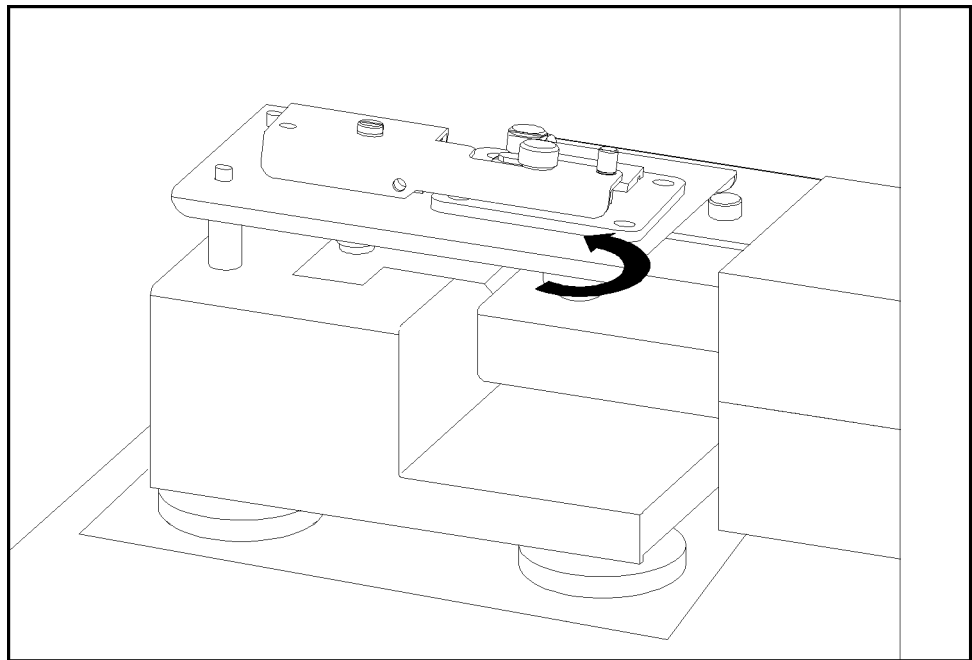

Figure C-3. 16194A Connection

Select your test fixture model number using the **(Meas)** hardkey.

Fixture Compensation

How to perform fixture compensation for the 16194A is shown below. For a basic measurement, the Open and Short compensations are required. However, if you use both the 16194A and the High Temperature Test Head for High Impedance, or the measurement frequency is above 500 MHz, the Load compensation is also required. The procedures for the 16453A and 16454A are shown in the applicable *Fixture Compensation* section in each quick start.

Short Compensation

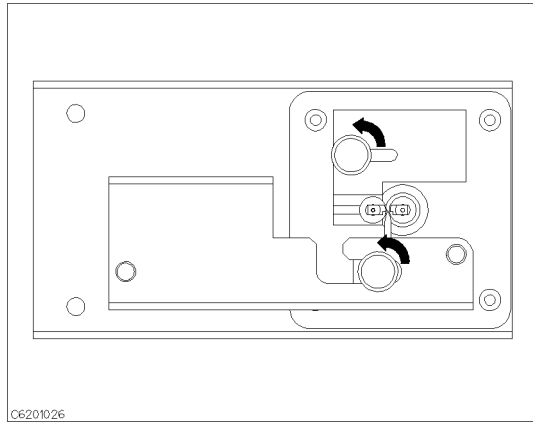

1. Loosen the two knobs.

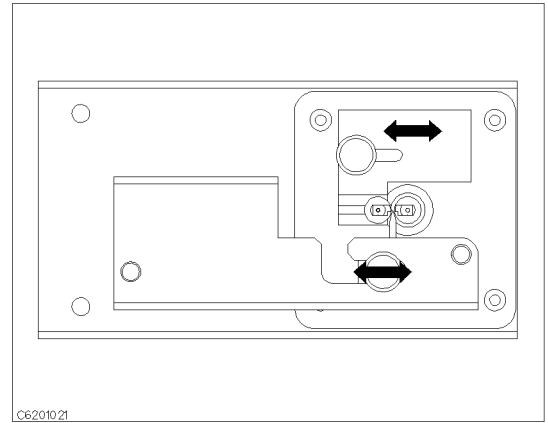

2. Adjust the stage and the pressure arm to fit your shorting device.

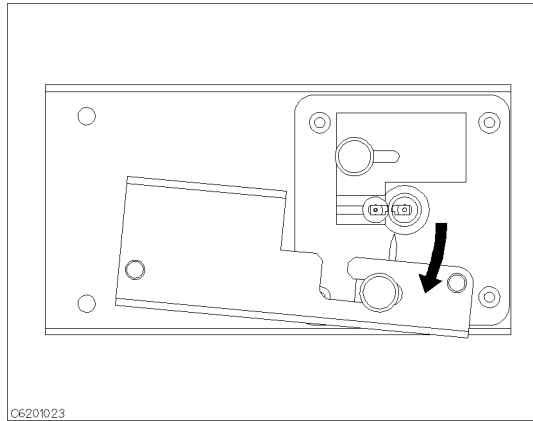

3. Move the pressure arm to the outside.

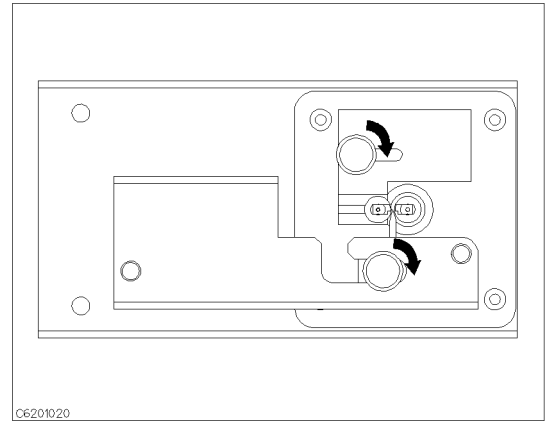

4. Tighten the two knobs.

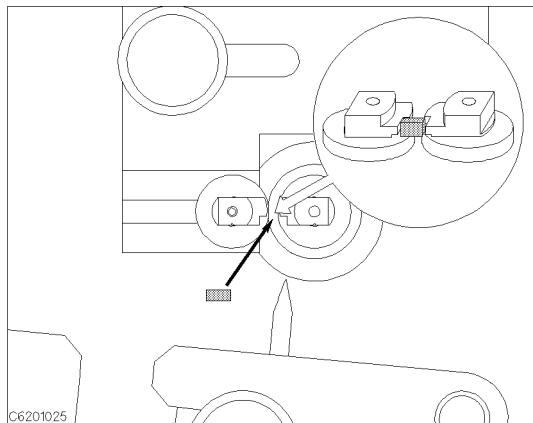

5. Place the shorting device so that it contacts both electrodes.

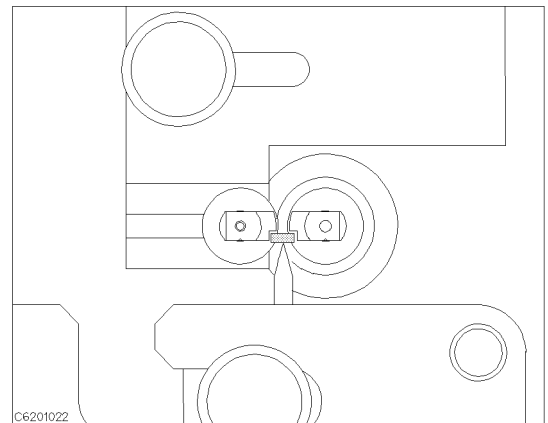

6. Release the pressure arm so that the shorting device is held by the pressure arm.

Temperature Coefficient Measurement

Note



When it is difficult to connect the device to the test fixture that is in the chamber, remove the test fixture from the test fixture stand. Then connect the device outside the chamber and set the fixture on the test fixture stand again.

When the test fixture is ready for the SHORT compensation sequence, press the following front panel keys:

1. Press **[Cal]** **FIXTURE COMPEN** **COMPEN MENU**.
2. Press **SHORT**.

After the SHORT compensation sequence is done, the **SHORT** softkey label is underlined.

Open Compensation

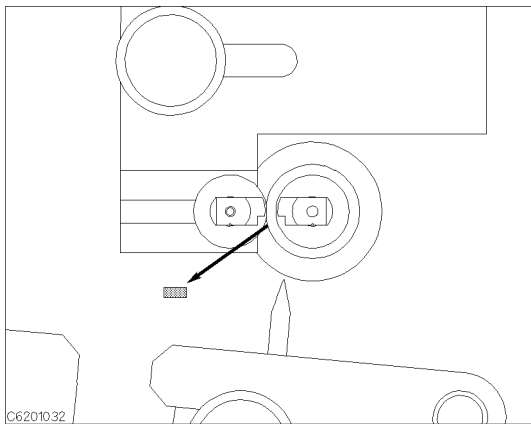

1. Remove the shorting device.

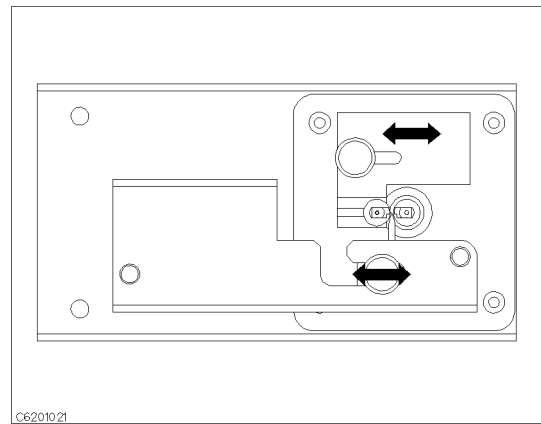

2. Adjust the stage and the pressure arm to fit your DUT.

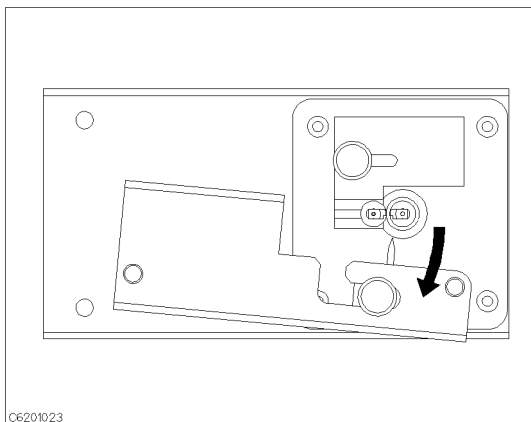

3. Move the pressure arm to the outside.

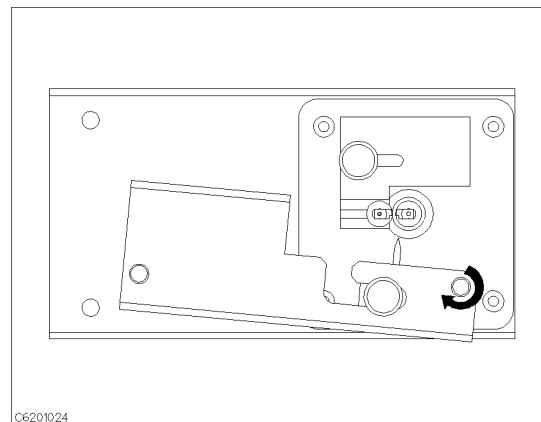

4. Turn the latch knob and insert it into the hole so that the pressure is locked.

When the test fixture is ready for the Open compensation sequence, perform the following procedure:

Temperature Coefficient Measurement

1. Press **OPEN**.

After the OPEN compensation sequence is done, the **OPEN** softkey label is underlined.

2. Press **DONE: COMPEN** if you do not intend to perform the Load compensation.

If you use both the 16194A and High Temperature Test Head for High Impedance, or the measurement frequency is above 500 MHz, the Load compensation is required.

Load Compensation

Connect the Load to the 16194A just as you connected the shorting device in the Short compensation. The Load device is included with 16194A.

When the test fixture is ready for the Load compensation sequence, perform the following procedure:

1. Press **LOAD**.

After the Load compensation sequence is done, the **LOAD** softkey label is underlined.

2. Press **DONE: COMPEN**.

Note



When your DUT is leaded type, the compensation procedure is as follows:

1. Perform the Short Compensation using the biggest shorting device (Agilent P/N 16191-29004).
2. Perform the Load Compensation using the furnished load device.
3. Replace the pressure arm pin for SMD with one for a leaded component.

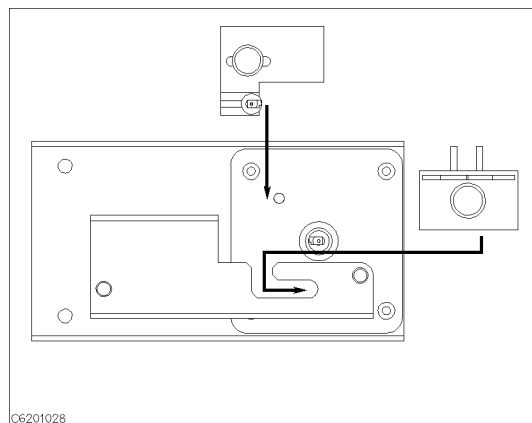

4. Adjust the stage to fit your DUT.
5. Perform the Open Compensation.

Temperature Coefficient Measurement

If you use both the 16194A and High Temperature Test Head for Low Impedance, and the measurement frequency is below 500 MHz, the Load compensation is not required.

Saving Status File

After performing calibration/fixture compensation at your required settings, save the settings with the calibration/fixture compensation data to the status file. In this example, setup A is saved using the name "ZTF".

1. Insert the data diskette (DOS formatted) into the floppy disk drive slot.
2. Press **Save** **STATE**.
3. Enter the file name "ZTF" and press **Return**.
4. The message of "SAVING "ZTF.STA" TO DISK" is displayed. The analyzer saves a status file with a ".STA" extension.

Error Messages

This section lists the error messages that are displayed on the analyzer display or transmitted by the instrument over GPIB. Each error message is accompanied by an explanation, and suggestions are provided to help in solving the problem. Where applicable, references are provided to the related chapter of the appropriate manual. The messages are listed in alphabetical order.

In the explanation of many error commands, section numbers of the IEEE standard 488.2 are included. Refer to them for further information about an error with these IEEE section numbers.

222 **1st LO OSC TEST FAILED**

An “internal test 9: A4A1 1ST LO OSC” fails. The 1st LO OSC (first local oscillator) on the A4A1 1st LO does not work properly. See the *Service Manual* for troubleshooting.

223 **2nd LO OSC TEST FAILED**

An “internal test 10: A3A2 2ND LO” fails. The 2nd LO OSC (second local oscillator) on the A3A2 2nd LO does not work properly. See the *Service Manual* for troubleshooting.

225 **3rd LO OSC TEST FAILED**

An “internal test 12: A6 3RD LO OSC” fails. The 3rd LO OSC (third local oscillator) on the A6 receiver IF does not work properly. See the *Service Manual* for troubleshooting.

224 **A3 DIVIDER OUTPUT FREQUENCY OUT OF SPEC**

An “internal test 11: A3A1 DIVIDER” fails. The output frequency of the divider circuit on the A3A1 ALC is out of its limits. See the *Service Manual* for troubleshooting.

243 **A6 GAIN TEST FAILED**

An “external test 23: A6 GAIN” fails. See the *Service Manual* for troubleshooting.

244 **A6 VI NORMALIZER TEST FAILED**

An “external test 24: A6 VI NORMALIZER” fails. See the *Service Manual* for troubleshooting.

Temperature Coefficient Measurement

- 6 **ADDITIONAL STANDARDS NEEDED**
- Error-correction coefficients cannot be computed until all the necessary standards have been measured. Execute all `OPEN`, `SHORT`, `LOAD` calibration (`SENSe:CORRection1:COLLect[:ACQuire]{STAN1|STAN2|STAN3}`) before press `DONE: CAL` (`SENSe:CORRection1:COLLect:SAVE`).
- 132 **BACKUP DATA LOST**
- Data checksum error on the battery backup memory has occurred. The battery is recharged for approximately 10 minutes after power was turned ON.
- 160 **Block data error**
- This error, as well as errors –161 and –168, are generated when analyzing the syntax of a block data element. This particular error message is used if the analyzer cannot detect a more specific error.
- 168 **Block data not allowed**
- A legal block data element was encountered but was not allowed by the analyzer at this point in parsing.
- 240 **CABLE ISOL'N TEST FAILED**
- An “external test 27: ” fails. See the *Service Manual* for troubleshooting.
- 10 **CALIBRATION ABORTED**
- The calibration in progress was terminated due to a change of the stimulus parameter or calibration measurement points. For example,
- Changing `CAL POINT [FIXED]` between `CAL POINT [USER]` (`SENSe:CORRection1:COLLect:FP0ints {FIXed|USER}`).
- 7 **CALIBRATION REQUIRED**
- No valid calibration coefficients were found when you attempted to perform fixture compensation. See *Users Guide* for information on how to perform calibration.
- 31 **CAN'T CALCULATE EQUIVALENT PARAMETERS**
- Data is not match to the equivalent circuit and cannot calculate the parameters.
- 120 **CAN'T CHANGE IN LIST SWEEP**
- When list sweep is selected, the following parameters are not allowed to be changed:
- Stimulus center, span, start, stop
 - Number of Point
 - OSC level

Temperature Coefficient Measurement

Modify the list table to change these parameters in the list sweep.

93 **CAN'T CHANGE WHILE DUAL CHAN OFF**

The cross channel (CALCulate:EVALuate:EFFect:ON 1) cannot be turned on when dual channel is off. Turn on the dual channel before the cross channel is turned on.

74 **CAN'T CHANGE- ANOTHER CONTROLLER ON BUS**

The analyzer cannot assume the mode of system controller until the system controller is removed from the bus or relinquishes the bus.

16 **CAN'T CHANGE-HIGH TEMP TEST HEAD CONNECTED**

You cannot execute `CAL POINTS [FIXED]` (`SENSe:CORRection1:COLLect:FP0ints FIXed`) or `COMP POINT [FIXED]` (`SENSe:CORRection2:COLLect:FP0ints FIXed`) when the high temperature test head is connected.

108 **CAN'T SAVE GRAPHICS WHEN COPY IN PROGRESS**

If you attempt to save graphics when a print is in progress, this error message is displayed. Wait until print is complete, then save graphics again.

-281 **Cannot create program**

An attempt to create a program was unsuccessful. A reason for the failure might include not enough memory.

-140 **Character data error**

This error, as well as errors –141 through –148, are generated when analyzing the syntax of a character data element. This particular error message is used if the analyzer cannot detect a more specific error.

-148 **Character data not allowed**

A legal character data element was encountered where prohibited by the analyzer.

-144 **Character data too long**

The character data element contains more than twelve characters (see IEEE 488.2, 7.7.1.4).

-100 **Command error**

This is a generic syntax error that the analyzer cannot detect more specific errors. This code indicates only that a command error, as defined in IEEE 488.2, 11.5.1.1.4, has occurred.

Temperature Coefficient Measurement

- 110 **Command header error**
- An error was detected in the header. This error message is used when the analyzer cannot detect the more specific errors described for errors –111 through –119.
- 67 **COMMAND IGNORED - SEGMENT NOT DONE YET**
- (GPIB only)* The GPIB command the analyzer received is ignored, because the segment is editing. Send `CALCulate:LIMit:SEGMent:SAVE` (limit segment done) or `SENSe:LIST:SEGMent:SAVE` (segment done) to terminate editing segment.
- 13 **COMPENSATION ABORTED**
- The compensation in progress was terminated due to a change of the stimulus parameter or calibration measurement points. For example,
- Changing `COMP POINT [FIXED]` between `COMP POINT [USER]` (`SENSe:CORRection2:COLLect:FP0ints {FIXed|USER}`) before pressing `DONE: COMPEN` (`SENSe:CORRection2:COLLect:SAVE`).
- 11 **COMPENSATION REQUIRED**
- No valid fixture compensation coefficients were found when you attempted to turn fixture compensation ON (`OPEN ON off –SENSe:CORRection2:OPEN ON`, `SHORT ON off –SENSe:CORRection2:SHORT ON`, `LOAD ON off –SENSe:CORRection2:LOAD ON`). See *Users Guide* for information on how to perform compensation.
- 15 **COMPENSATION STD LIST UNDEFINED**
- (GPIB only)* You cannot execute `SENSe:CORRection2:CKIT[1]:STANdard{1-3}[:SElect] LIST` when the fixture compensation standard array is not defined.
- 190 **CORR. CONST. DATA LOST; DEFAULT DATA IS USED**
- This message is displayed when the correction constants EEPROM data is lost and turned on in the service mode. See the *Service Manual* for troubleshooting.
- 190 **CORR. CONST. DATA LOST; DEFAULT DATA IS USED**
- This message is displayed when the correction constants EEPROM data is lost and turned on in the service mode. See the *Service Manual* for troubleshooting.
- 212 **CPU BACKUP SRAM R/W ERROR**
- An “internal test 2: A1 VOLATILE MEMORY” fails. The A1 CPU’s BACKUP SRAM does not work properly. Replace the A1 CPU with a new one. See the *Service Manual* for troubleshooting.

Temperature Coefficient Measurement

211 CPU INTERNAL SRAM R/W ERROR

An “internal test 2: A1 VOLATILE MEMORY” fails. The A1 CPU’s internal SRAM does not work properly. Replace the A1 CPU with a new one. See the *Service Manual* for troubleshooting.

66 CURRENT EDITING SEGMENT SCRATCHED

The current editing the table of list sweep or the limit line is scratched. It is occur when the operation other than editing the table is executed before terminate editing the table (SENSe:LIST:SAVE, or CALCulate:LIMit:SAVE)

-230 Data corrupt or stale

Possibly invalid data. New reading started but not completed since last access.

-225 Data out of memory

The analyzer has insufficient memory to perform the requested operation.

-222 Data out of range

A legal program data element was parsed but could not be executed because the interpreted value was outside the legal range as defined by the analyzer (see IEEE 488.2, 11.5.1.1.5).

-231 Data questionable

Measurement accuracy is suspect.

-104 Data type error

The parser recognized an unallowed data element. For example, numeric or string data was expected but block data was encountered.

127 DC BIAS OVERLOAD

Hardware failure. Do not input external DC BIAS. If this message keeps on being displayed, contact your nearest Agilent Technologies service office.

229 DC BIAS TEST FAILED

An “internal test 16: DC BIAS” fails. See the *Service Manual* for troubleshooting.

210 DIN CHIP TEST FAILED

An “internal test 1: A1 CPU” fails. The A1 CPU’s DIN control chip does not work properly. Replace the A1 CPU with a new one. See the *Service Manual* for troubleshooting.

Temperature Coefficient Measurement

204 **DSP CHIP TEST FAILED**

An “internal test 1: A1 CPU” fails. The A1 CPU’s DSP (Digital Signal Processor) does not work properly. Replace the A1 CPU with a new one. See the *Service Manual* for troubleshooting.

213 **DSP SRAM R/W ERROR**

An “internal test 2: A1 VOLATILE MEMORY” fails. The DSP’s SRAM on the A1 CPU does not work properly. Replace the A1 CPU with a new one. See the *Service Manual* for troubleshooting.

214 **DUAL PORT SRAM R/W ERROR**

An “internal test 2: A1 VOLATILE MEMORY” fails. The DSP’s dual port SRAM on the A1 CPU does not work properly. Replace the A1 CPU with a new one. See the *Service Manual* for troubleshooting.

111 **DUPLICATE FILE EXTENSION**

The extension name (GRAPHICs [] or ASCII DATA [] — MMEmory:FNAME:EXTension{1|2}) is already used for other file types. Use other extension name.

203 **EEPROM CHECK SUM ERROR**

An “internal test 1: A1 CPU” fails. The data (Correction Constants and so on) stored in the A1 CPU’s EEPROM are invalid. See the *Service Manual* for troubleshooting.

199 **EEPROM WRITE ERROR**

Data cannot be stored properly into the EEPROM on the A1 CPU, when performing the display background adjustment or updating correction constants in the EEPROM using the adjustment program. See the *Service Manual* for troubleshooting.

-200 **Execution error**

This is the generic syntax error that the analyzer cannot detect more specific errors. This code indicates only that an execution error as defined in IEEE 488.2, 11.5.1.1.5 has occurred.

-123 **Exponent too large**

The magnitude of the exponent was larger than 32000 (see IEEE 488.2, 7.7.2.4.1).

205 **F-BUS TIMER CHIP TEST FAILED**

An “internal test 1: A1 CPU” fails. The A1 CPU’s F-BUS (Frequency Bus) timer does not work properly. Replace the A1 CPU with a new one. See the *Service Manual* for troubleshooting.

Temperature Coefficient Measurement

218 **FAILURE FOUND FROM A/D MUX TO A/D CONVERTER**

An “internal test 5: A6 A/D CONVERTER” fails. A trouble is found on the signal path from the A/D multiplexer to A/D converter on the A6 receiver IF. See the *Service Manual* for troubleshooting.

217 **FAN POWER OUT OF SPEC**

An “internal test 4: A2 POST REGULATOR” fails. The voltage of the fan power supply at the DC bus node 11 is out of its limits. See the *Service Manual* for troubleshooting.

208 **FDC CHIP TEST FAILED**

An “internal test 1: A1 CPU” fails. The A1 CPU’s FDC (Flexible Disk drive control) chip does not work properly. Replace the A1 CPU with a new one. See the *Service Manual* for troubleshooting.

-257 **File name error**

A legal program command or query could not be executed because the file name on the device media was in error. For example, an attempt was made to copy to a duplicate file name. The definition of what constitutes a file name error is device-specific.

-256 **File name not found**

A legal program command could not be executed because the file name on the device media was not found: for example, an attempt was made to read or copy a nonexistent file.

230 **FLOPPY DISK DRIVE FAILURE FOUND**

An “external test 18: DSK DR FAULT ISOL’N” fails. The A53 built-in FDD (floppy disk drive) does not work properly. Replace the A53 FDD with a new one. See the *Service Manual* for troubleshooting.

220 **FRACTIONAL N OSC TEST FAILED**

An “internal test 7: A5 FRACTIONAL N OSC” fails. The fractional N oscillator on the A5 synthesizer does not work properly. See the *Service Manual* for troubleshooting.

119 **FREQUENCY SWEEP ONLY**

Equivalent circuit function is executed in OSC level sweep, DC-I sweep, DC-V sweep. The equivalent circuit function is available in frequency sweep only.

95 **FREQUENCY SWEEP ONLY**

Cannot select MKR X AXIS $[1/(2\pi F)]$ in OSC level sweep, or DC-V/DC-I sweep.

Temperature Coefficient Measurement

- 239 **FRONT ISOL'N TEST FAILED**
An “external test 25: FRONT ISOL'N” fails. See the *Service Manual* for troubleshooting.
- 105 **GET not allowed**
A Group Execute Trigger (GET) was received within a program message (see IEEE 488.2, 7.7).
- 216 **GND LEVEL OUT OF SPEC**
An “internal test 4: A2 POST REGULATOR” fails. The voltage of the GND (Ground) at the DC bus node 26 is out of its limits. See the *Service Manual* for troubleshooting.
- 240 **Hardware error**
A legal program command or query could not be executed because of a hardware problem in the analyzer. Definition of what constitutes a hardware problem is completely device-specific. This error message is used when the analyzer cannot detect the more specific errors described for errors –241 through –249.
- 241 **Hardware missing**
A legal program command or query could not be executed because of missing analyzer hardware. For example, an option was not installed.
- 111 **Header separator error**
A character that is not a legal header separator was encountered while parsing the header. For example, no white space followed the header, thus *SRE4 is an error.
- 248 **HIGH TMP HIGH Z HEAD TEST FAILED**
An “external test 32: HIGH TMP HIGH Z HEAD TEST FAILED” fails. See the *Service Manual* for troubleshooting.
- 249 **HIGH TMP LOW Z HEAD TEST FAILED**
An “external test 33: HIGH TMP LOW Z HEAD TEST FAILED” fails. See the *Service Manual* for troubleshooting.
- 237 **HIGH Z HEAD TEST FAILED**
An “external test 30: HIGH Z HEAD” fails. See the *Service Manual* for troubleshooting.
- 114 **Header Suffix out of range**
The value of a numeric suffix attached to a program mnemonic makes the header invalid.

Temperature Coefficient Measurement

237 **HI Z HEAD TEST FAILED**

An “external test 30: HIGH Z HEAD” fails. See the *Service Manual* for troubleshooting.

209 **HP-IB CHIP TEST FAILED**

An “internal test 1: A1 CPU” fails. The A1 CPU’s GPIB chip does not work properly. Replace the A1 CPU with a new one. See the *Service Manual* for troubleshooting.

-224 **Illegal parameter value**

Used where exact value, from a list of possibilities, was expected.

-282 **Illegal program name**

The name used to reference a program was invalid. For example, redefining an existing program, deleting a nonexistent program, or in general, referencing a nonexistent program.

-283 **Illegal variable name**

An attempt was made to reference a nonexistent variable in a program.

-213 **Init ignored**

A request for a measurement initiation was ignored as another measurement was already in progress.

141 **INSUFFICIENT MEMORY**

If a lot of tasks is executed at same time, memory might be insufficient for a while. (For example, running HP Instrument BASIC program, printing a screen, and sending or receiving data array by GPIB are required at same time.) Please wait until finishing some tasks then execute the next task.

-161 **Invalid block data**

A block data element was expected, but was invalid for some reason (see IEEE 488.2, 7.7.6.2). For example, an END message was received before the length was satisfied.

-101 **Invalid character**

A syntax element contains a character that is invalid for that type. For example, a header containing an ampersand (SENS&).

-141 **Invalid character data**

Either the character data element contains an invalid character or the particular element received is not valid for the header.

Temperature Coefficient Measurement

- 121 **Invalid character in number**
- An invalid character for the data type being parsed was encountered. For example, an alpha character in a decimal numeric or a “9” in octal data.
- 148 **INVALID DATE**
- The date entered to set the real time clock is invalid. Reenter correct date.
- 106 **INVALID FILE NAME**
- (*GPIB only*) The parameter *<file_name>* for MMEMoRY:DELeTe command must have a “_D” or “_S” extension for LIF format, or “STA” or “.DAT” for DOS format.
- 77 **INVALID MATERIAL SIZE**
- (For the permeability measurement) The material size definition is wrong. The outer diameter must be larger than the inner.
- 103 **Invalid separator**
- The parser was expecting a separator and encountered an illegal character. For example, the semicolon was omitted after a program message unit, *RST:INIT.
- 151 **Invalid string data**
- A string data element was expected, but was invalid for some reason (see IEEE 488.2, 7.7.5.2). For example, an END message was received before the terminal quote character.
- 131 **Invalid suffix**
- The suffix does not follow the syntax described in IEEE 488.2, 7.7.3.2, or the suffix is inappropriate for the analyzer.
- 160 **INVALID X-AXIS VALUE FOR LOG**
- User trace cannot be displayed in log scale, because,
- The right value and left value of the X-axis is same.
 - The X-axis range is defined from – value to + value.
- Change the X-axis right/left value.
- 207 **KEY CHIP TEST FAILED**
- An “internal test 1: A1 CPU” fails. The A1 CPU’s front keyboard control chip does not work properly. Replace the A1 CPU with a new one. See the *Service Manual* for troubleshooting.
- 115 **LIF-DOS COPY NOT ALLOWED**
- If you try to copy a file between the memory disk and the floppy disk when the format of the memory disk is different from the format of the floppy disk, this message is displayed.

Temperature Coefficient Measurement

118 LIST TABLE EMPTY OR INSUFFICIENT TABLE

The frequency list is empty. To implement the list frequency mode, add segments to the list table.

238 LO Z HEAD TEST FAILED

An “external test 31: LOW Z HEAD” fails. See the *Service Manual* for troubleshooting.

238 LOW Z HEAD TEST FAILED

An “external test 31: LOW Z HEAD” fails. See the *Service Manual* for troubleshooting.

-250 Mass storage error

A mass storage error occurred. This error message is used when the analyzer cannot detect the more specific errors described for errors –251 through –259.

78 MATERIAL SIZE UNDEFINED

(For the permittivity and permeability measurement) The **DONE (MODIFIED)** key (under **Meas MATERIAL SIZE**) is pressed or it is attempt to select the measurement parameter key when the material sizes are empty. Define the material size before press these keys.

245 MAX VCXO LEVEL OUT OF SPEC

Maximum VCXO level is incorrect, in performing an “adjustment test 36: 3RD VCXO LEVEL ADJ” or an “adjustment test 39: SOURCE VCXO LEVEL ADJ”. See the *Service Manual* for troubleshooting.

33 MEM-TRACE MEMORY FULL

Another memory trace cannot be saved because the total NOP of memory traces exceeds (801 × 3).

-311 Memory error

An error was detected in the analyzer’s memory.

-109 Missing parameter

Fewer parameters were received than required for the header. For example, the *SRE command requires one parameter, so receiving only *SRE is not allowed.

32 MUST BE MORE THAN 2 POINTS FOR ANALYSIS

CALCULATE EQV PARAMS (CALCulate:EVALuate:EPARAMeters) is pressed when the NOP (number of points) is 2. Set the number of measurement points to the number lager than 2.

Temperature Coefficient Measurement

92 NO ACTIVE MARKER

(*GPIB only*) The marker→ command cannot be execute when no marker is displayed on the screen. Turn on the marker before executing the marker→ commands.

9 NO CALIBRATION CURRENTLY IN PROGRESS

The RESUME CAL SEQUENCE softkey (No GPIB command) is not valid unless a calibration is in progress. Start a new calibration. See “**Cal** key” in the *Operation Manual*.

12 NO COMPENSATION CURRENTLY IN PROGRESS

The RESUME COMP SEQ softkey (No GPIB command) is not valid unless a fixture compensation is in progress. Start a new calibration. See “**Cal** key” in the *Function Reference* .

87 NO DATA TRACE

The MARKER ON [DATA] (CALCulate:EVALuate:ON1 "TR1") is selected when the data trace is not displayed.

113 NO DATA TRACE DISPLAYED

The SCALE FOR [DATA] (DISPlay[:WINDow]:TRACe1:Y[:SCALe]) is selected when the data trace is not displayed.

+0 No error

The error queue is empty. Every error in the queue has been read (SYSTem:ERRor? query) or the queue was cleared by power-on or the *CLS command.

94 NO FIXED DELTA MARKER

The Δmarker cannot move (ΔMKR STIMULUS , FIXED ΔMKR VALUE or FIXED Δ AUX VALUE—CALCulate:EVALuate:REFErence:{X|Y1|Y2} <numeric> cause the error) because,

- The Δmarker is not turned on. → Turn the Δmarker ON (DISPlay[:WINDow]:TRACe:MARKer:RELative ON).
- The only fixed Δmarker can move by FIXED ΔMKR VALUE or FIXED Δ AUX VALUE . → Press FIXED ΔMKR (DISPlay[:WINDow]:TRACe:MARKer:RELative:REFErence FIXed).

90 NO MARKER DELTA - RANGE NOT SET

The MKRΔ—SEARCH RNG softkey (CALCulate:EVALuate:BAND:SPAN DMARker) requires that Δmarker is turned ON.

Temperature Coefficient Measurement

89 NO MARKER DELTA - SPAN NOT SET

The **MKRA→SPAN** softkey (SENSe:FREQuency:SPAN DMarkEr, or SOURce{1|2}:{VOLTage|CURRent}:SPAN DMarkEr”) requires that the Δmarker mode be turned ON.

88 NO MEMORY TRACE

The **MARKER ON [MEMORY]** (CALCulate:EVALuate:ON1 "TR{2-17}") is selected when the memory trace is not displayed.

114 NO MEMORY TRACE DISPLAYED

The **SCALE FOR [MEMORY]** (DISPlay[:WINDow]:TRACe{2-17}:Y[:SCALe]) is selected when the memory trace is not displayed.

107 NO STATE/DATA/IBASIC FILES ON DISK

(Front-panel key only) The **RE-SAVE FILE**, **COPY FILE**, **PURGE FILE**, or **Recall** key pressed, but there are no files with extensions (“_D” or “_S” for LIF format, or “.STA” or “.DAT” for DOS format) on the floppy disk.

110 NO STATE/DATA/IBASIC FILES ON MEMORY

(Front-panel key only) The **RE-SAVE FILE**, **COPY FILE**, **PURGE FILE**, or **Recall** key pressed, but there are no files with extensions (“_D” or “_S” for LIF format, or “.STA” or “.DAT” for DOS format) on the memory disk.

75 NO TEST HEAD CONNECTED

Check the test head connection.

30 NO VALID MEMORY TRACE

If memory traces are to be displayed or otherwise used, a data trace must first be stored to memory.

159 NO VALID USER TRACE

The marker cannot be used in user trace because the selected user trace is OFF.

14 NOT ALLOWED IN DC BIAS SWEEP

The calibration **CAL POINTS [USER]** (SENSe:CORRection1:COLLect:FPOints USER) or compensation in **COMP POINT [USER]** (SENSe:CORRection2:COLLect:FPOints USER) cannot be executed in the DC-V/DC-I sweep.

Temperature Coefficient Measurement

121 NOT ALLOWED IN FREQUENCY SWEEP

`SWEEP DIR []` (`SOURCE{1|2}:SWEep:DIRection DOWN`) is pressed in frequency sweep. Sweep direction down is only available for OSC level sweep, DC-V, or DC-I sweep.

189 NOT ALLOWED IN SVC MODE

Dual channel cannot be displayed in the service mode.

80 NOT AVAILABLE FOR THIS FIXTURE

(*GPIB only*) You cannot execute `CALCulate:MATH1[:EXPRession]:NAME {DC0|PER}` when the `SYSTem:FIXTure {NONE|16191|16192|16193|16194}` is selected.

79 NOT AVAILABLE FOR THIS FORMAT

(For the permittivity and permeability measurement)
You cannot execute `POLAR CHART`, `SMITH CHART`, and `ADMITTANCE CHART` (`DISPlay[:WINDow]:TRACe1:GRATICule:FORMat {POLar|SMITH|ADMittance}`).

47 NOT ENOUGH DATA

(*GPIB only*) The amount of data sent to the analyzer is less than that expected when the data transfer format is binary.

-120 Numeric data error

This error, as well as errors –121 through –129, are generated when parsing a data element that appears to be numeric, including the nondecimal numeric types. This particular error message is used if the analyzer cannot detect a more specific error.

-128 Numeric data not allowed

A legal numeric data element was received, but the analyzer does not accept it in this position for a header.

140 ON POINT NOT ALLOWED FOR THE CURRENT TRIG

The trigger event mode cannot be changed to the ON POINT mode because the current trigger source setting does not allow the ON POINT mode. The trigger event ON POINT mode is available for only MANUAL, EXTERNAL, and BUS trigger sources.

48 OPTION NOT INSTALLED

(*GPIB only*) This error occurs when an GPIB command which is optional command is sent and the analyzer is not installed the option. Please confirm options installed to the analyzer using `*OPT?` command (see Chapter 3 of GPIB Command Reference.)

Temperature Coefficient Measurement

233 **OUTPUT ATTENUATOR TEST FAILED**

An “external test 21: OUTPUT ATTENUATOR” fails. See the *Service Manual* for troubleshooting.

-220 **Parameter error**

Indicates that a program data element related error occurred. This error message is used when the analyzer cannot detect the more specific errors described for errors –221 through –229.

-108 **Parameter not allowed**

More parameters were received than expected for the header. For example, the *SRE command only accepts one parameter, so receiving *SRE 4,16 is not allowed.

40 **PHASE LOCK LOOP UNLOCKED**

Sever error. Contact your nearest Agilent Technologies office.

215 **POST REGULATOR OUTPUT VOLTAGE OUT OF SPEC**

An “internal test 4: A2 POST REGULATOR” fails. A power supply voltage of the A2 post-regulator is out of its limits. See the *Service Manual* for troubleshooting.

198 **POWER ON TEST FAILED**

An internal test fails in the power on sequence (the power on self-test fails). Contact your nearest Agilent Technologies office or see the *Service Manual* for troubleshooting.

231 **POWER SWEEP LINEARITY TEST FAILED**

An “external test 19: POWER SWEEP LINEARITY” fails. See the *Service Manual* for troubleshooting.

22 **PRINTER: not on, not connected, out of paper**

The printer does not respond to control. Check the supply to the printer, online status, sheets, and so on.

-284 **Program currently running**

Certain operations dealing with programs may be illegal while the program is running. For example, deleting a running program might not be possible.

-280 **Program error**

A downloaded program-related execution error occurred. This error message is used when the analyzer cannot detect the more specific errors described for errors –281 through –289.

Temperature Coefficient Measurement

- 112 **Program mnemonic too long**
The header contains more than twelve characters (see IEEE 488.2, 7.6.1.4.1).
- 286 **Program runtime error**
A program runtime error of the HP Instrument BASIC has occurred. To get a more specific error information, use the ERRM\$ or ERRN command of the HP Instrument BASIC.
- 285 **Program syntax error**
A syntax error appears in a downloaded program. The syntax used when parsing the downloaded program is device-specific.
- 430 **Query DEADLOCKED**
A condition causing a deadlocked query error occurred (see IEEE 488.2, 6.3.1.7). For example, both input buffer and output buffer are full and the analyzer cannot continue.
- 400 **Query errors**
This is the generic query error that the analyzer cannot detect more specific errors. This code indicates only that a query error as defined in IEEE 488.2, 11.5.1.1.7 and 6.3 has occurred.
- 410 **Query INTERRUPTED**
A condition causing an interrupted query error occurred (see IEEE 488.2, 6.3.2.3). For example, a query followed by DAB or GET before a response was completely sent.
- 420 **Query UNTERMINATED**
A condition causing an unterminated query error occurred (see IEEE 488.2, 6.3.2.2). For example, the analyzer was addressed to talk and an incomplete program message was received by the controller.
- 350 **Queue overflow**
A specific code entered into the queue in lieu of the code that caused the error. This code indicates that there is no room in the queue and an error occurred but was not recorded.
- 105 **RECALL ERROR: INSTR STATE PRESET**
A serious error, for example corrupted data, is detected on recalling a file, and this forced the analyzer to be PRESET.
- 242 **RECEIVER GAIN OUT OF SPEC**
An “external test 25: FRONT ISOL’N” fails. A6 receiver IF gain is incorrect. See the *Service Manual* for troubleshooting.

Temperature Coefficient Measurement

241 **RECEIVER GAIN TEST FAILED**

An “external test 22: RECEIVER GAIN” fails. See the *Service Manual* for troubleshooting.

219 **REF OSC TEST FAILED**

An “internal test 6: A5 REFERENCE OSC” fails. The reference oscillator on the A5 synthesizer does not work properly. See the *Service Manual* for troubleshooting.

206 **RTC CHIP TEST FAILED**

An “internal test 1: A1 CPU” fails. The A1 CPU’s RTC (Real Time Clock) does not work properly. Replace the A1 CPU with a new one. See the *Service Manual* for troubleshooting.

227 **SAMPLE FREQUENCY OUT OF SPEC**

An “internal test 14: A6 SEQUENCER” fails. The sampling frequency of the sample/hold circuit on the A6 receiver IF is out of its limits.

104 **SAVE ERROR**

A serious error, for example physically damaged disk surface, is detected on saving a file.

68 **SEGMENT START/STOP OVERLAPPED**

Segments are not allowed to be overlapped. Reenter appropriate value for start or stop value of segments to avoid that segment is not overlapped.

-330 **Self-test failed**

A self-test failed. Contact your nearest Agilent Technologies office or see the *Service Manual* for troubleshooting.

-221 **Settings conflict**

A legal program data element was parsed but could not be executed due to the current device state (see IEEE 488.2, 6.4.5.3 and 11.5.1.1.5).

228 **SOURCE LEVEL TEST FAILED**

An “internal test 15: SOURCE LEVEL” fails. See the *Service Manual* for troubleshooting.

232 **SOURCE LEVEL TEST FAILED**

An “external test 20: SOURCE LEVEL” fails. See the *Service Manual* for troubleshooting.

Temperature Coefficient Measurement

- 226 **SOURCE OSC TEST FAILED**
- An “internal test 13: A3A1 SOURCE OSC” fails. The source oscillator on the A3A1 ALC does not work properly. See the *Service Manual* for troubleshooting.
- 221 **STEP OSC TEST FAILED**
- An “internal test 8: A5 STEP OSC” fails. The step oscillator on the A5 synthesizer does not work properly. See the *Service Manual* for troubleshooting.
- 150 **String data error**
- This error, as well as errors –151 and –158, are generated when analyzing the syntax of a string data element. This particular error message is used if the analyzer cannot detect a more specific error.
- 158 **String data not allowed**
- A string data element was encountered but was not allowed by the analyzer at this point in parsing.
- 130 **Suffix error**
- This error, as well as errors –131 through –139, are generated when parsing a suffix. This particular error message is used if the analyzer cannot detect a more specific error.
- 138 **Suffix not allowed**
- A suffix was encountered after a numeric element that does not allow suffixes.
- 134 **Suffix too long**
- The suffix contained more than 12 characters (see IEEE 488.2, 7.7.3.4).
- 102 **Syntax error**
- An unrecognized command or data type was encountered. For example, a string was received when the analyzer was not expecting to receive a string.
- 310 **System error**
- Some error, termed “system error” by the analyzer, has occurred.
- 124 **Too many digits**
- The mantissa of a decimal numeric data element contains more than 255 digits excluding leading zeros (see IEEE 488.2, 7.7.2.4.1).

Temperature Coefficient Measurement

- 56 **TOO MANY SEGMENTS**
The maximum number of segments for the limit line table is 18.
- 69 **TOO MANY SEGMENTS OR POINTS**
Frequency list mode is limited to 15 segments or 801 points.
- 223 **Too much data**
A legal program data element of block, expression, or string type was received that contained more data than the analyzer could handle due to memory or related device-specific requirements.
- 46 **TOO MUCH DATA**
(*GPIB only*) Either there is too much binary data to send to the analyzer when the data transfer format is binary, or the amount of data is greater than the number of points.
- 70 **TOO SMALL POINTS OR TOO LARGE STOP**
STOP + SPAN/(NOP-1) is out of sweep range. Increase NOP or change STOP value to lower frequency to avoid this error.
- 235 **TRD ISOL'N I TO V TEST FAILED**
An "external test 28: TRD ISOL'N I TO V" fails. See the *Service Manual* for troubleshooting.
- 236 **TRD ISOL'N V TO I TEST FAILED**
An "external test 29: TRD ISOL'N V TO I" fails. See the *Service Manual* for troubleshooting.
- 234 **TRD LOSS TEST FAILED**
An "external test 22: TRD LOSS" fails. See the *Service Manual* for troubleshooting.
- 210 **Trigger error**
A trigger related error occurred. This error message is used when the analyzer cannot detect the more specific errors described for errors -211 through -219.
- 211 **Trigger ignored**
A GET, *TRG, or triggering signal was received and recognized by the analyzer but was ignored because of analyzer timing considerations. For example, the analyzer was not ready to respond.
- 113 **Undefined header**
The header is syntactically correct, but it is undefined for the analyzer. For example, *XYZ is not defined for the analyzer.

Temperature Coefficient Measurement

158 **UNIT STRING TOO LONG**

(*GPIB only*) DISPLAY[:WINDow]:TRACe{18-21}:X:UNIT <*string*> or DISPLAY[:WINDow]:TRACe{18-21}:Y:UNIT <*string*> commands can send <*string*> up to 4 characters.

76 **UNKNOWN TEST HEAD CONNECTED**



The test head get wrong. Contact your nearest Agilent Technologies office.

246 **VCXO TUNING VOLTAGE OUT OF LIMIT**

VCXO tuning voltage is incorrect, in performing an “adjustment test 36: 3RD VCXO LEVEL ADJ” or an “adjustment test 39: SOURCE VCXO LEVEL ADJ”. See the *Service Manual* for troubleshooting.

Index

Special characters

$\Delta L.F$, 7-22
 $\Delta R.F$, 7-22
 $\Delta mode$, 7-21
 ΔX , 7-26
 ΔY , 7-26
* , 2-7
 , 4-2
 , 4-2
-0 , 2-7
 \uparrow , 2-7
 , 4-2

- 1** 10833A GPIB cable(1 m), 10-5
 - 10833B GPIB cable(2 m), 10-5
 - 10833C GPIB cable(3 m), 10-5
 - 10833D GPIB cable(0.5 m), 10-5
 - 16091A coaxial termination fixture set , 10-3
 - 16092A spring clip test fixture , 10-3
 - 16093A/B binding post test fixtures , 10-4
 - 16094A probe test fixture , 10-4
 - 16191A Component test fixture , 1-2
 - 16191A side electrode SMD test fixture , 10-3
 - 16192A Component test fixture , 1-2
 - 16192A parallel electrode SMD test fixture , 10-3
 - 16193A Component test fixture , 1-2
 - 16193A small side electrode SMD test fixture , 10-3
 - 16194A high temperature component fixture , 10-3
 - 16194A High temperature component test fixture , 1-3
 - 16453A dielectric material test fixture , 10-3
 - 16453A Dielectric material test fixture , 1-3
 - 16454A Magnetic material test fixture , 1-3, 10-3
-
- 4** 4291V upgrade kit, 10-2
 - 46021A keyboard , 12-51

8 85043B system rack , 10-4

A accessory , 12-51
accessory part number, 12-51
active channel, 3-2
active channel , 2-4
active channel block, 1-4
active channel block , 3-1
active entry area , 2-8
AD converter, 9-3
addressable , 8-46
addressable only , 8-19
address setting , 8-19
adjust display , 5-42
ADJUST DISPLAY , 5-35
Admittance, 11-4
Agilent part number, 12-51
APC-7 , 2-17
approximate , 12-1
AUTOREC , 8-39, 8-50
auto recall , 8-39, 8-50
auto scaling , 5-49
aux offset , 5-39
averaging , 5-52, 9-4
averaging factor , 5-52
averaging ON Avg , 2-7
Avg , 2-7

B B, 11-4
background intensity , 5-42
Back Space , 4-3
BACK SPACE , 5-46
BASIC , 8-4
BASIC draw , 5-36
BASIC screen , 5-36
battery backup, B-1
beeper , 8-4
block , 1-1
block diagram , 9-1
brightness , 5-44
Bus , 2-7
bus trigger , 6-13
BW, 7-22
Bw/Avg , 1-5

C C, 11-4
 C! , 2-7
 C+ , 2-7
 C+ , 2-7
 C+! , 2-7
 C+? , 2-7
 C? , 2-7
Cal , 1-5
 calibration , 5-55
 calibration coefficient arrays , 9-4
 calibration coefficients arrays , 8-49
 cal kit , 1-2
 calkit , 5-60
 cal points , 5-55
 Capacitance, 11-4
 cent, 7-22
Center , 1-5
 center value , 2-6
Chan 1 , 3-2
Chan 2 , 3-2
 channel coupling , 6-4
 circuit model, 11-6
 clear markers, 7-5
 clock , 8-4
 Cm! , 2-7
 Cm? , 2-7
 Cmp , 2-7
 CMP , 2-7
 C0+ , 2-7
 color , 5-44
 color monitor , 2-10
 color printer , 8-23
 color reset , 5-44
 compen kit , 5-62
 compensation coefficient arrays , 9-5
 compensation points , 5-57
 complex permeability , 11-30
 complex permittivity , 11-26
 complex plane , 5-30
 Conductance, 11-4
 connectors , 2-9
 continuous marker, 7-5
 continuous mode, 7-21
 controller , 8-45
 controller address , 8-19
Copy , 1-6, 8-22
 copy abort , 8-29
 copy time ON OFF , 8-29
 Cor , 2-7
 COR , 2-7
 coupling channel , 6-4
 coupling channels , 3-2
 Cp1 , 2-5
 cross channel, 7-9

CROSS CHAN on OFF , 7-9
cw freq , 6-10
cw frequency , 2-6

D D*M , 2-7
data arrays , 8-49, 9-5
data math , 5-34, 5-38, 9-6
data math gain ON G* , 2-7
data math offset ON -0 , 2-7
data math ON D-M, D+M, D/M, Hld , 2-7
DATA & MEMORY , 5-33
data only, 8-49
data processing , 9-2
DATA—MEMORY , 5-33
Data-Trace arrays , 8-49
data trace arrays , 9-6
dc bias , 6-10
dc bias option , 10-1
D (Dissipation Factor), 11-4
default color, 5-44
default colors , 5-43
default gain offset , 5-39
delay time , 6-4
Δmarker , 7-6
Δmarker, 7-6
Δmarker—funciton , 7-9
ΔMKR SWP PARAM , 7-6
Δmode , 7-21
delta mode ON OFF, 7-6
digital filter, 9-3
discrete marker, 7-5
discrete mode, 7-21
disk capacity , 8-48
disk format , 8-48
display , 2-4, 5-33
Display , 1-5
display adjustment , 5-42
display allocation , 5-33, 5-36
DATA MATH , 5-35
DISPLAY: DATA , 5-33
display limit table , 8-28
display list sweep table , 8-28
D+M , 2-7
D/M , 2-7
D-M, 2-7
dual channel , 5-33
dual parameter setting , 5-12

- E** edge effect , 11-27
 emc , 12-21
 END EDIT , 8-7
 entry block , 4-1
 (Entry Off) , 4-3
 equivalent circuit , 5-40
 equivalent circuit model, 11-6
 ERASE TITLE , 5-46
 error message, Messages-1
 expanded phase ON OFF , 5-30
 Ext , 2-7
 external program run/cont input , 2-10
 external reference, 2-7
 external reference input , 2-9
 external trigger , 6-13
 external trigger input , 2-10
- F** factory setting, B-1
 fast sweep indicator ↑ , 2-7
 file name , 8-50
 fixed cal points , 5-55
 fixed compensation points , 5-57
 fixed delta marker , 7-6
 FIXED ΔMKR AUX VALUE , 7-6
 FIXED ΔMKR VALUE , 7-6
 fixed Δmarker, 7-6
 fixture compensation , 5-57, 5-58, 5-59
 fixture compensation coefficient arrays , 9-5
 fixture setting , 5-14
 fixture stand , 1-3
 floppy disk , 12-51
 floppy disk drive , 2-3
 footnote , 5-48
 format , 5-30, 9-6
 (Format) , 1-4
 frequency base , 6-8
 frequency blank , 5-35
 front panel , 2-1
 function reference , 12-51
- G** G, 11-4
 gain, 5-39
 gain , 5-38
 G* , 2-7
 G+jB , 7-19
 (G/n) , 4-2
 G&0 , 2-7
 GPIB , 8-44
 GPIB address , 8-19, 8-47
 GPIB cable, 10-5
 GPIB command reference , 12-51
 GPIB interface , 2-10
 graphics, 8-49

graphics , 5-36
graticule on off , 5-35

H handle kit option , 10-2
headline , 5-48
heat sink , 2-14
height , 5-29
high impedance test head , 1-2
high impedance test head delete option , 10-1
high stability frequency reference add option , 10-2
high temperature high impedance test head , 1-3
high temperature high impedance test head add option , 10-1
high temperature low impedance test head , 1-3
high temperature low impedance test head add option , 10-1
H1d , 2-7
HP DeskJet 1200 color printer, 10-4
HP DeskJet 1600CM color printer, 10-4
HP DeskJet 340J color printer, 10-4
HP DeskJet 505 printer, 10-4
HP DeskJet 560C color printer, 10-4
HP DeskJet 694C color printer, 10-4
HP DeskJet 850C color printer, 10-4
hp-hil keyboard cable , 12-51
hp instrument basic users handbook , 12-51

I **IBASIC** , 5-43
I↓, 2-7
Impedance, 11-3
 Parameters, 11-3
impedance measurement , 5-9, 5-12
initialize, B-1
inner diameter , 5-29
instrument BASIC , 8-4
Instrument data arrays , 8-49
instrument state block , 1-6
Instrument states and internal data arrays , 8-49
intensity , 5-42
internal reference output , 2-10
introduction , 1-1
i/o port , 2-10, 2-11
i/o port pin assignment , 2-11
I-V method , 11-12

K key
 Back Space , 4-3
 ↓, 4-2
 ↑, 4-2
 Chan 1 , 3-2
 Chan 2 , 3-2
 Entry Off , 4-3
 G/n , 4-2
 k/m , 4-2
 M/μ , 4-2

- terminator key , 4-2
- (x1)**, 4-2
- keyboard , 12-51
- keyboard cable , 12-51
- keyboard connector , 2-10
- keyboard template , 12-51
- (k/m)**, 4-2
- knob , 4-2

L

- L, 11-4
- label , 5-35, 5-45
- LCD , 2-4
- left peak, 7-14
- level monitor , 2-5, 6-11
- LIF (logical inter change format) , 8-48
- limit line concept , 8-40
- limit test , 8-14
- linear sweep , 6-5
- line switch , 2-3
- listener , 8-44
- list sweep , 6-5
- (Local)** , 1-6, 8-19
- logging ON OFF , 8-4
- log sweep , 6-5
- loss, 7-22
- low impedance test head , 1-2
- low impedance test head add option , 10-1
- low-loss air-capacitor calibration , 11-12

M

- main frame , 1-2
- man , 2-7
- manual changes, A-1
- manual trigger , 6-13
- marker, 7-20
 - coupled maker , 3-2
- marker , 7-4
- (Marker)** , 1-5, 7-3
- marker block , 1-5
- marker coupling, 7-5
- marker data readout , 2-5
- marker list, 7-19
- marker→ , 7-7
- marker search, 7-22
- marker statistics , 2-5
- marker time mode , 7-20
- (Marker→)**, 1-5
- material measurement firmware option , 10-1
- material size , 5-22, 5-29
- Max, 2-5
- MAX** , 7-11
- max search, 7-11
- (Meas)**, 1-4
- (Meas)** , 5-3
- measured input , 2-5

measurement block, 1-4
measurement block , 5-1
measurement circuit , 11-12
measure restart , 6-13
memory arrays , 8-49, 9-5
memory disk , 8-48
memory partition , 8-4
memory trace , 5-33, 5-36
memory trace arrays , 8-49, 9-6
memory trace number , 5-33
menu , 2-2
message area, 2-8
Min, 2-5
MIN , 7-11
min search, 7-11
MKRA→CENTER , 7-9
MKRA→SEARCH RNG , 7-15
MKRA→SPAN , 7-9
MKR→REFERENCE , 7-9
MKR→CENTER , 7-9
MKR→LEFT RNG , 7-15
MKR→PEAK DELTA , 7-13
MKR→RIGHT RNG , 7-15
MKR→START , 7-9
MKR→STOP , 7-9
MKR→THRESHOLD , 7-13
MKR ZOOM , 7-9
M/μ, 4-2
modify colors , 5-42
modify compen kit , 5-62, 5-64
mounting post , 2-13
mounting screw, 2-13

N next peak, 7-14
NEXT PEAK (SEANPK), 7-14
NEXT PEAK LEFT (SEANPKL), 7-14
NEXT PEAK RIGHT (SEANPKR), 7-14
nominal , 12-1
non-volatile memory, B-1
nop , 6-4
notations , 2-7
number of points , 6-4
numeric keypad , 4-2

O offset , 5-38
option 001 add dc bias , 10-1
option 002 add material measurement firmware , 10-1
option 011 delete high impedance test head , 10-1
option 012 add low impedance test head , 10-1
option 013 add high temperature high impedance test head , 10-1
option 014 add high temperature low impedance test head , 10-1
option 0BW add service manual , 10-2
option 1D5 , 2-9, 2-10
option 1D5 add high stability frequency reference , 10-2
Option Keyboard less, 10-2
options available , 10-1
order base , 6-8
osc level , 6-10
outer diameter , 5-29

P parallel circuit model, 11-6
Parallel Resistance, 11-4
part number , 12-51
PART SRCH on OFF , 7-15
pass/fail , 2-5
Peak, 2-5
PEAK (SEAM PEAK), 7-14
PEAK—CENTER , 7-9
peak definition, 7-26
PEAK DEF MENU , 7-11
peak delta, 7-13
PEAK DELTA: ΔX , 7-13
PEAK DELTA: ΔY , 7-13
Peak menu , 7-13
PEAK PLRTY POS neg , 7-13
peak polarity, 7-13
peak polarity , 7-26
PEN , 5-43
pen color , 5-43
performance , 12-1
performance test , 12-1
permeability measurement , 5-23, 11-29
permittivity measurement , 5-17, 11-26
phase unit , 5-30
POINT AVG FACTOR , 5-52
POINT AVG on OFF , 5-52
port extension , 5-66, 9-5, 11-16
power , 2-10
power level , 2-6
Preset , 1-6, 2-3, 8-21
preset marker , 7-5
preset state, B-1
printer, 10-4
printer address , 8-19
printer port , 2-10
print standard , 8-26

programme menu , 8-4
programming guide , 12-51

Q Q, 7-22
Q (Quality Factor), 11-4
Quick Start Guide , 12-51

R R, 11-3
rack mount and handle kit option , 10-2
rack mount kit option , 10-2
raw data arrays , 8-49, 9-4
Reactance, 11-3
rear panel , 2-9
Recall , 1-6, 8-39
recall color , 5-43
recall file , 8-39
recharge time, B-1
reference level , 2-5
reference oven output , 2-10
reference position , 5-49
reference value , 5-49
relaxation time , 7-19
REMOTE indicator , 2-3
Resistance, 11-3
right peak, 7-14
 $R+jX$, 7-19
 R_p , 11-4
 R_s , 11-3
run/cont input , 2-10

S sample program disk , 12-51
Save , 1-6, 8-30
save color , 5-43
SAVE COLORS , 5-43
scale coupling , 5-50
scale/div , 2-5
scale for data , 5-50
scale for memory , 5-50
scale per div , 5-49
Scale Ref , 1-5
scale reference , 5-49
scaling , 9-6
scan speed of 31.5 kHz, 2-10
screen display , 2-4
search, 7-22
Search , 1-5
SEARCH LEFT (SEAL), 7-12
search menu , 7-11
SEARCH: PEAK , 7-11
search range, 7-15
SEARCH RANGE MENU , 7-11
search range menu , 7-15

SEARCH RIGHT (SEAR), 7-12
 SEARCH TRK on OFF , 7-11
 segment , 6-7, 8-40
 SEL'D UTRC ON off , 5-48
 SELECT LETTER , 5-46
 serial number, A-2
 series circuit model, 11-6
 service manual , 12-51
 service manual add option, 10-2
 service menu , 8-5
 Smith polar marker , 7-19
 smth/polar menu , 7-19
Source , 1-5, 6-10
 SPACE , 5-46
Span , 1-5
 span value , 2-6
 specifications , 12-1
 split display , 5-33
 standard model , 5-61
Start , 1-5, 6-14
 start value , 2-6
 state, 8-49
 statistics ON OFF , 7-19
 status notations , 2-7
 step key , 4-2
 stimulus block , 1-5
Stop , 1-5
 stop value , 2-6
 storage devices , 8-48
 sub marker , 7-5
 SUB MKR , 7-12
 Susceptance, 11-4
 Svc, 2-7
Sweep , 1-5, 6-3
 SWEEP AVG FACTOR , 5-52
 SWEEP AVG ON off , 5-52
 SWEEP AVG RESTART , 5-52
 sweep direction , 6-5
 sweep hold , 6-12
 sweep time , 6-4
 sweep type , 6-5
System , 1-6
System , 8-3
 system accessory, 10-4
 system controller , 8-19, 8-45, 8-46
 system overview , 1-2, 9-1
 system rack, 10-4

- T**
- talker , 8-44
 - Targ, 2-5
 - TARGET , 7-11
 - TARGET (SEATARG), 7-12
 - target menu , 7-12
 - target search, 7-11
 - teflon , 5-64
 - terminator key , 4-2
 - test head , 2-15
 - test station , 1-2, 2-13, 2-14
 - test station connector , 2-3
 - TEXT MARKER , 5-43
 - θ , 11-3
 - thickness , 5-22
 - threshold , 7-13
 - THRESHOLD on OFF , 7-13
 - threshold value, 7-26
 - THRESHOLD VALUE , 7-13
 - time stamp , 8-29
 - tint , 5-44
 - title , 2-8, 5-35, 5-46
 - tracking delta marker , 7-6
 - TRACKING Δ MKR , 7-6
 - Trigger , 1-5, 6-12
 - trigger event , 6-13
 - trigger input , 2-10
 - trigger signal polarity , 6-13
 - typical , 12-1
 - typically , 12-1
- U**
- upgrade kit, 10-2
 - user defined cal points , 5-55
 - user defined compensation points , 5-57
 - user kit , 5-64
 - user trace , 5-47
 - user trace format , 5-31
 - user trace scale , 5-51
 - Utility , 1-5
 - utility menu , 7-18
- V**
- V_d, 2-7
 - video port, 2-10
 - video signal, 2-10

W warm up time , 12-1
width function, 7-16
width search, 7-22
width value , 2-5

X X, 11-3

Y |Y|, 11-4
Ŷ, 11-4

Z |Z|, 11-3
Ż, 11-3
ZOOMING APERTURE , 7-9

REGIONAL SALES AND SUPPORT OFFICES

For more information about Agilent Technologies test and measurement products, applications, services, and for a current sales office listing, visit our web site: <http://www.agilent.com/find/tmdir>. You can also contact one of the following centers and ask for a test and measurement sales representative. 11/29/99

United States:

Agilent Technologies
Test and Measurement Call Center
P.O.Box 4026
Englewood, CO 80155-4026
(tel) 1 800 452 4844

(fax) (61 3) 9272 0749
(tel) 0 800 738 378 (New Zealand)
(fax) (64 4) 802 6881

Canada:

Agilent Technologies Canada Inc.
5150 Spectrum Way
Mississauga, Ontario
L4W 5G1
(tel) 1 877 894 4414

Asia Pacific:

Agilent Technologies
24/F, Cityplaza One, 1111 King's Road,
Taikoo Shing, Hong Kong
(tel) (852)-3197-7777
(fax) (852)-2506-9284

Europe:

Agilent Technologies
Test & Measurement
European Marketing Organization
P.O.Box 999
1180 AZ Amstelveen
The Netherlands
(tel) (31 20) 547 9999

Japan:

Agilent Technologies Japan Ltd.
Call Center
9-1, Takakura-Cho, Hachioji-Shi,
Tokyo 192-8510, Japan
(tel) (81) 426 56 7832
(fax) (81) 426 56 7840

Latin America:

Agilent Technologies
Latin American Region Headquarters
5200 Blue Lagoon Drive, Suite #950
Miami, Florida 33126
U.S.A.
(tel) (305) 267 4245
(fax) (305) 267 4286

Australia/New Zealand:

Agilent Technologies Australia Pty Ltd
347 Burwood Highway
Forest Hill, Victoria 3131
(tel) 1-800 629 485 (Australia)